



MagFlux[®] Series

ELECTROMAGNETIC FLOWMETER

mjk 
a xylem brand

Your notes:

Table of Contents

MJK declaration of conformity.....	8
Introduction.....	9
Introduction - MagFlux® Q.....	9
Operating principles.....	9
The MagFlux® Flow Meter.....	10
Safety, repair and product identification.....	11
Safety instructions.....	11
Physical mounting.....	12
Repair.....	12
MJK product identification.....	12
Flow sensor.....	14
Minimum conductivity.....	14
Liner selection.....	14
Liner selection, cont.....	14
Electrode selection.....	14
Mounting location.....	14
Pressure loss.....	16
Accuracy.....	17
MJK sizing.....	17
Sizing chart.....	20
Pipe system.....	23
Pipe system - MagFlux Q special conditions.....	27
Cabinet mounted on the flow sensor.....	28
Potential equalization and grounding.....	28
Type 7100/7200/8200 in conductive pipes.....	28
MagFlux® in conductive pipes, MagFlux® Q.....	29
Type 7100/7200/8200 in non-conductive pipes.....	29
MagFlux® in non-conductive pipes, MagFlux® Q.....	29
Cathodic protection.....	30
Type 7100/7200 in conductive pipes.....	30
Type 7100/7200 in non-conductive pipes.....	30
Flow converter.....	31
Electrical mounting.....	31
Power supply.....	32
Change power supply voltage 230/115 V AC.....	33
Analogue output.....	36
Digital outputs.....	36
Digital input.....	37
Local (compact) flow sensor.....	38
Remote flow sensor.....	38
Converter connection board - local.....	40
MJK Connection board - remotely mounted converter.....	41
System configuration examples.....	42

MJK compact converter and display unit on flow sensor.....	42
MJK remote converter with connection box on flow sensor	42
Wiring schematic #1	43
MJK remote display and multiple converters wiring	44
Wiring schematic #2.....	45
Startup.....	47
MJK initial checks.....	47
Initial flow measurement.....	47
Flow direction check	47
Language selection	47
MJK display read-out, one connected unit	48
Display read-out, several connected units	48
MJK display keys.....	49
Initial setup	50
MagFlux® menus	53
Main menu.....	53
Specify main screen.....	54
MJK factory settings	55
Data logger.....	60
Graph display	61
Password.....	62
Set sensor name.....	64
Converter setup	65
Minimum flow.....	67
Averaging	69
Units.....	70
mA output.....	70
Flow forward.....	71
Flow reverse	72
Forward & rev. (12mA=0)	73
Forward & rev. (4mA=0)	74
Not in use.....	75
MJK totalizers	75
Settings and limits for resettable totalizers	76
Resettable totalizers	79
MJK batch counters 1 & 2.....	82
Settings and limits for batch counters.....	87
High flow/low flow	90
Flow direction.....	92
Empty pipe	94
24h flow.....	95
Status.....	95
Service menu.....	97
Sensor calibration code	97
Converter software ver.....	98
Product info	99

Reset counter time.....	99
Internal meas. & cal.	100
Minimum velocity.....	100
Calibrate mA.....	101
Test velocity.....	103
Freeze coil	104
Read eventlog	105
Back on stock	105
Popup on/off.....	106
Zero point calibration.....	106
Verification.....	108
Display setup.....	108
MJK communication modules documentation.....	109
Language.....	109
Set clock.....	111
Modbus.....	111
Add Device.....	112
Change Device Address.....	113
Remove Device	114
Change Display ID No.....	115
Set No. of Retries	115
Change Modbus speed.....	116
Factory setting setup.....	116
Display SW version.....	117
Mechanical dimensions	118
MJK standard flanges - EN-1092-1_2001 - Europe.....	118
MagFlux Q sensor sizes and torque.....	120
MJK standard flanges - ANSI B 16.5 - U.S.A.....	121
MJK standard flanges - AS-4087-2004 - Australia.....	125
MJK standard flanges - AS-4087-2004 (continued #1).....	127
MJK standard flanges - AS-4087-2004 (continued #2).....	129
Appendix A. Pop-up and error messages.....	132
Appendix B. MJK Field Link™ software.....	136
System Requirements MJK Field Link™.....	136
Download MJK Field Link™ and connect a PC to the MagFlux® flow meter.....	136
Save log data.....	138
Upgrade display firmware.....	138
Upgrade converter firmware.....	139
Install/Add languages.....	140
Appendix C. FAQs.....	142
Appendix D. Front panel cut-out drawing	144
MJK cut-out download.....	145
Appendix E. MJK test certificate	146
Appendix F. Log files	147
Appendix G. Digital input/output connections	151
Appendix H. Remote slave display unit.....	152

Connection board for remote slave display unit	153
Converter connection board with master display unit	154
Wiring.....	155
Configuration for the master unit	155
Configuration for the slave unit	155
Main menu overview	156
Converter setup menu overview	158
Service menu overview	164
Display setup menu overview	168

Contact

You can always contact your local representative or the MJK hotline for advice and guidance:

Europe: Tel.: +45 45 56 06 56, e-mail: mjk@mjk.com

Visit our web site www.mjk.com to learn more about MJK Automation, our other products and the people behind them.

MJK declaration of conformity

DOC - CE



Konformitetserklæring

Vi, MJK Automation ApS, DK-3460 Birkerød, påtager os det fulde ansvar for at produktet

Declaration of Conformity

We, MJK Automation ApS, DK-3460 Birkerød, declare under our sole responsibility that the product

Declaração de Conformidade

Nós, MJK Automation ApS, DK-3460 Birkerød, declaramos sob nossa única responsabilidade que o produto

MagFlux® Electromagnetic Flowmeter

som denne erklæring angår, er i overensstemmelse med følgende standard(er) eller andre normdokument(er).

to which this declaration relates is in conformity with the following standard(s) or other normative document(s).

a que se refere esta declaração está em conformidade com a seguinte norma (s) ou outro documento normativo (s) seguindo

Declaration de conformite

Nous, MJK Automation ApS, DK-3460 Birkerød, déclarons sous notre seule responsabilité que le produit

Dichiarazione di conformità

Noi, MJK Automation ApS, DK-3460 Birkerød, dichiariamo sotto la nostra esclusiva responsabilità che l'apparecchio

Declaración de conformidad

Nosotros, MJK Automation ApS, DK-3460 Birkerød, declaramos bajo nuestra única responsabilidad que el producto

MagFlux® Electromagnetic Flowmeter

auquel se réfère cette déclaration est conforme à la (aux) norme(s) ou autre(s) document(s) normatif(s)

al quale questa dichiarazione si riferisce, è conforme alla seguente normativa(e) standard o ad altri documenti di normativa(e)

al cual se refiere esta declaración, está en conformidad con la(s) siguiente(e) norma(s) u otros documentos normativos

EMC Directive 2014/30/EU EN 61000-6-4 2007 EN 61000-6-2 2005	RoHS Directive 2011/65/EU	UL508
		CAN/CSA C22.2

Birkerød, 9.December 2019

Carsten Sønder, Managing Director MJK

MJK Automation ApS • Blokken 9 • DK-3460 Birkerød • Tel: +45 45 56 06 56 • mjk@mjk.com • www.mjk.com

INT 3.05 MagFlux DOC 1912

Introduction

The MagFlux® is suitable for flow measurement in all kinds of conductive fluids, and it is especially suited for flow measurement of water, waste water, sludge and other fluids containing particles.

The flow meter is easy to install and put into service. However, read this manual first to learn about the MagFlux® electromagnetic flow meter and all its features.

Introduction - MagFlux® Q

MagFlux® Q is especially suited for seawater and similar conditions as it is created in ABS plast, no outer parts in metal.

Operating principles

The MagFlux® electromagnetic flow meter is an instrument for measuring the flow of conductive fluid using Faraday's electromagnetic induction law, and consequently the fluid must be electrically conductive.

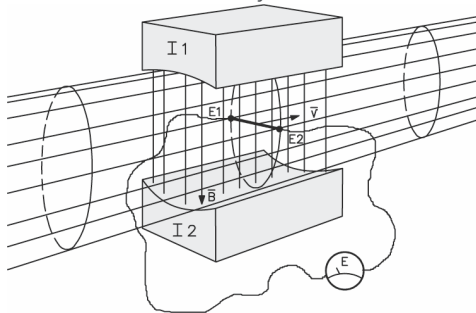

As illustrated above, a magnetic field with density B - perpendicular to the direction of flow - stretches across a fluid flowing within an electrically isolated pipe.

The magnetic flux will induce a voltage difference (E) that can be measured between two electrodes arranged perpendicular to the direction of flow and the magnetic field. The voltage is proportional to the velocity (V) of the fluid.

1. **$E = B \times D \times V \times k$ [Volt] where**

E is the voltage that is induced between the two electrodes

B is the magnetic flux density

D is the distance between the two electrodes

V is the fluid velocity

k is a dimensionless constant

The flow of the fluid Q (m^3/s) is given by the following formula:

2. **$Q = \pi \times D^2 \times V / 4 \Rightarrow V = 4 / (\pi \times D^2)$ where**

π : is the constant pi (= 22/7)

D: is the internal diameter

V: is the fluid velocity

The combination of above formulas 1. and 2. gives the following formula:

$$E = K \times B \times D \times Q \times 4 / (\pi \times D \times D) = 4 K \times B \times Q / (\pi \times D)$$

Evidently, the voltage E is proportional to the actual flow.

The MagFlux® Flow Meter

Measurement

Electromagnetic flow meters may have either direct current (DC) or alternating current (AC) excitation. When systems are AC excited, electrostatic and/or electromagnetic noise may influence the measurements. A DC excited system however, is less sensitive to noise produced by electromagnetic induction, simply because the voltage induced over the electrodes will be a DC voltage. The drawbacks are measurement errors due to electrochemical polarization between the electrodes and the fluid.

The MagFlux® flow meters are excited by a 2.5 Hz square wave and thereby eliminate the drawbacks of both DC and AC systems.

A microprocessor receives and measures the amplitude of the pulse with a 16-bit resolution, and converts and displays the result on the display unit.

Electrode cleaning

Electrode cleaning is always activated to maintain clean and accurate electrodes. The operating principle is a 55 Hz AC voltage superimposed on the normal 2.5 Hz square wave. This step effectively reduces the risk of a dirt layer build-up on the electrodes that eventually will deteriorate and finally isolate electrical contact to the flow media.

Safety, repair and product identification

Safety instructions

1. Read this manual carefully.
2. Pay attention to the environment on the installation site.
3. Wear necessary protective equipment and follow all current safety regulations.
4. The MagFlux® can invoke a start signal for dangerous machinery. Always ensure that connected machinery and other equipment are effectively put out of service (that is to remove the main fuses and lock main and security switches in off-position) before commencing configuration, fault finding, servicing, maintenance work, etc.

Warning: There is a risk of lethal, electrical shock from **Mains supply** terminals named **N** and **L** or - and +. Be careful not to touch these terminals - marked in red in the following - while the MagFlux® is being serviced.

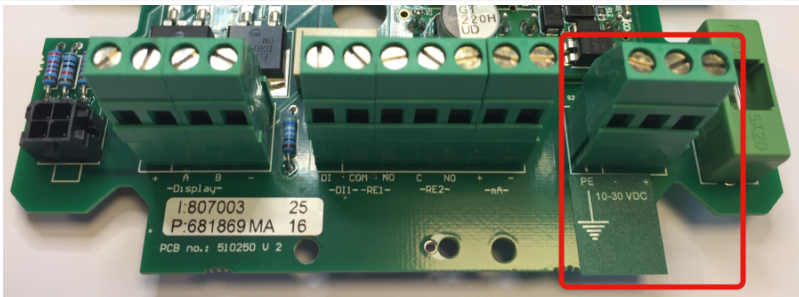

10-30 VDC

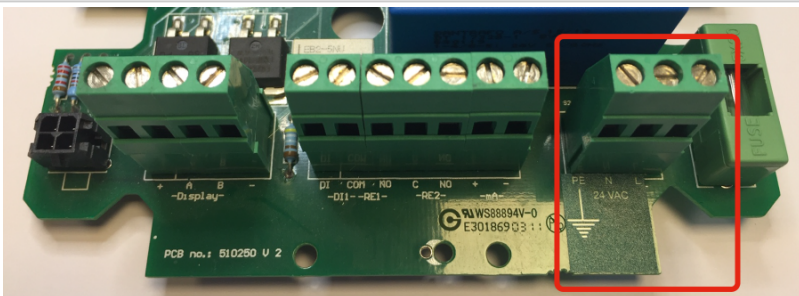

24 VAC

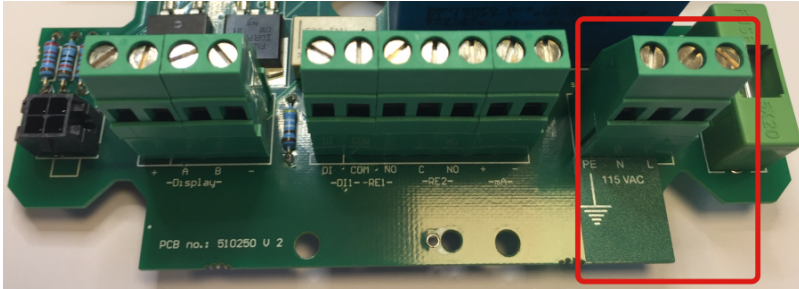

115 VAC

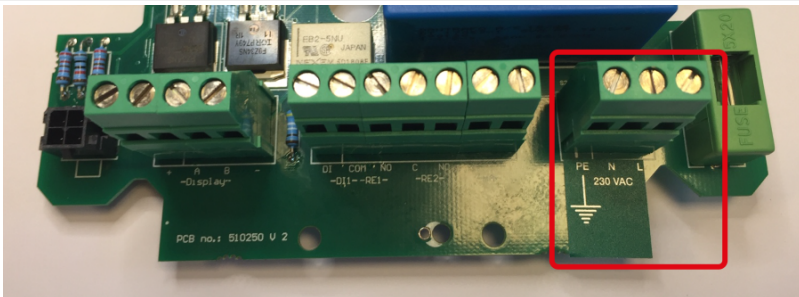

230 VAC

Physical mounting

The MagFlux® flow converter/flow meter **must not** be mounted in explosion hazardous areas!

Repair

Repair must only be made by this company or by a service representative approved by us.

MJK product identification

A delivery will usually consist of a MagFlux® converter and a MagFlux® flow sensor. Check that the item(s) delivered corresponds to the ordered item(s). The part number, serial number, calibration code and electrode/lining data are printed on an identification label on the flow sensor (see the following example):

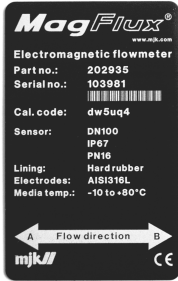

This calibration code (**Cal. code**) is unique and provides the MagFlux® converter with information about flow sensor number, nominal diameter of the flow sensor and calibration data for the flow sensor.

The current converter firmware requires an eight character input, but also accepts six characters plus two **OK**. The current example (dw5uq4) would require that you enter: **d w 5 u q 4 OK OK**, where **OK** indicates that you press the **OK** key without selecting any character. Only lower case letters can be entered via the MagFlux® keypad.

If changes are needed to the unique sensor calibration code following initial setup, this is the calibration code that the **Sensor Calibration Code** menu must contain (see [Initial setup](#) (see page 50)).

Flow sensor

The following conditions must be obtained to get the full benefit of the MagFlux® flow sensor.

Minimum conductivity

The conductivity of the measured media must be greater than 5 $\mu\text{S}/\text{cm}$.

Liner selection

- Use **hard rubber** lining for drinking water and waste water.

Liner selection, cont.

- Use **PTFE** lining for chemicals and food industries
- Use **ABS** lining for seawater (applies to MagFlux® Q only).

Electrode selection

- **Steel AISI 316TI-1.4571** for general purpose, sewage, water and district heating systems
- **Hastelloy** for sea water.
- **Tantalum, titanium and platinum** for chlorine and other aggressive chemicals.

Mounting location

To obtain a stable and accurate flow measurement it is very important that the flow sensor is mounted correctly in the pipe system.

- There must be no flow fluctuations.
- Avoid locations where vacuum can occur; especially for flow sensors with PTFE linings.
- Avoid locations with vibrations from, for example, pumps.
- Avoid locations with extensive temperature changes.
- Avoid corrosive environments and locations with a great risk of condensation, or consult factory for special builds for these locations.
- Avoid air at the measuring point.
- Take care that condensate and water cannot enter the connector box on the flow sensor.
- There must be sufficient free space around the flow sensor.

However, the MagFlux® can be buried in a well or closed dug-down space. It is created with a significant layer of protective paint preventing rust. But gravel and dirt can wear the paint, thereby decreasing the level of protection. Therefore, it is strongly recommended to leave a gravel-free and dry space for the MagFlux® installation as illustrated below.

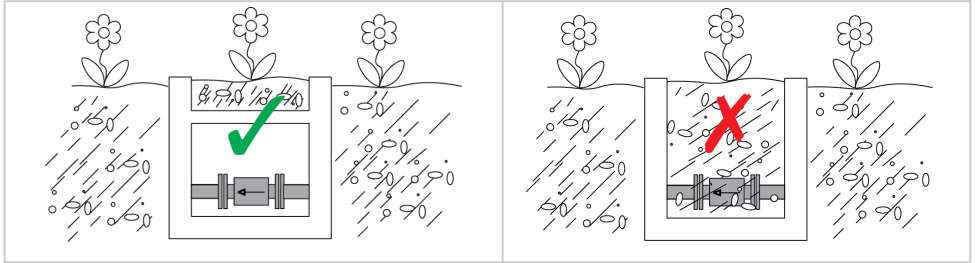

Important: Observe that the correct flow direction is set in the MagFlux® **Converter Setup** menu and in the **Service Menu**. Default flow direction is A (flow direction towards left).

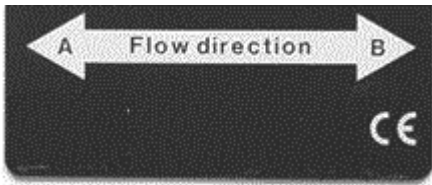

The flow directions A or B are clearly shown on the name plate.

Pressure loss

Pressure loss can easily be determined, if the nominal pipe diameter is greater than the MagFlux® flow sensor. See this pressure loss diagram:

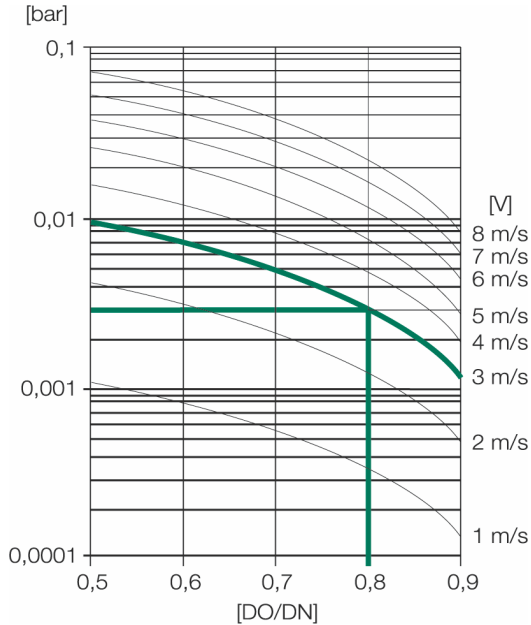

The diagram illustrates that decreasing the internal diameter from 100 mm (DN) to 80 mm (DO) will cause a pressure loss of 0.003 Bar @3 m/s.

Accuracy

According to the type and size of the flow sensor, the measuring accuracy will be better than 0.25%, provided that the flow sensor has the correct dimension.

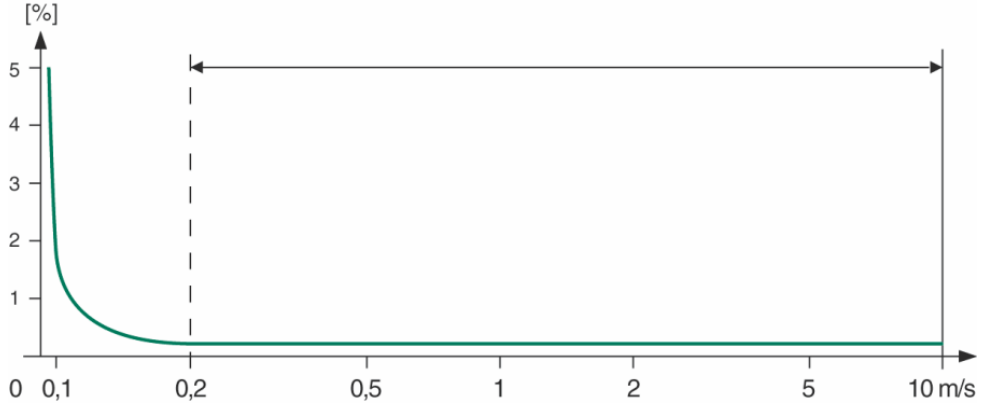

MJK sizing

The flow sensor should be selected so the flow velocity through the sensor will be between 0.2-10 m/s. We recommend that flow velocities in tubes are kept between 1-3 m/s for reliable and safe operation. See also the dimensioning table below and the dimensioning chart in the following section.

Min and max flow, metrics		
DN	Qmin	Qmax
	0.2 m/s	10 m/s
	[l/h]	[l/h]
15	127	6362
20	226	11304
25	353	17676
32	579	28944
40	905	45360

50	1414	70560
----	------	-------

Min and max flow, metrics		
DN	Qmin	Qmax
	0.2 m/s	10 m/s
	[m³/h]	[m³/h]
65	2,39	119
80	3,62	181
100	5,65	283
125	8,84	442
150	12,7	636
200	22.6	1131
250	35.3	1767
300	50.9	2545
350	69.3	3464
400	90.5	4524
450	115	5726
500	141	7069
600	204	10179
700	277	13854
800	362	18095
900	458	22902
1000	565	28274

Min and max flow, metrics		
DN	Qmin	Qmax
	0.2 m/s	10 m/s
	[m³/h]	[m³/h]
1200	814	40715

The Q_{max} is equal to 20 mA factory preset.

Min and max flow, imperial		
	Qmin	Qmax
	0.6 ft./s	30 ft./s
	[GPM]	[GPM]
1/2"	0.559	28.0
3/4"	0.995	49.76
1"	1.550	77.82
1 1/4"	2.549	127.4
1 1/2"	3.984	199.7
2"	6.226	310.7
2 1/2"	10.52	523.9
3"	15.93	796.9
4"	24.87	1246
5"	38.92	1946
6"	55.91	2800
8"	99.50	4,979
10"	155.4	7,780
12"	224.1	11,205
14"	305.1	15,258

Min and max flow, imperial		
	Qmin	Qmax
	0.6 ft./s	30 ft./s
	[GPM]	[GPM]
16"	398.5	19,919
18"	506.3	25,210
20"	620.8	31,120
24"	999.1	44,910
28"	1220	74,920
32"	1594	79,620
36"	2017	100,800
40"	2497	124,500
48"	3584	179,300

Sizing chart

Example: A MagFlux® with an internal diameter of 100 mm can measure flow rates between approx. 5.6 m³/h and 290 m³/h and the fluid velocity is 1.5 m/s at a flow rate of approx. 42 m³/h.

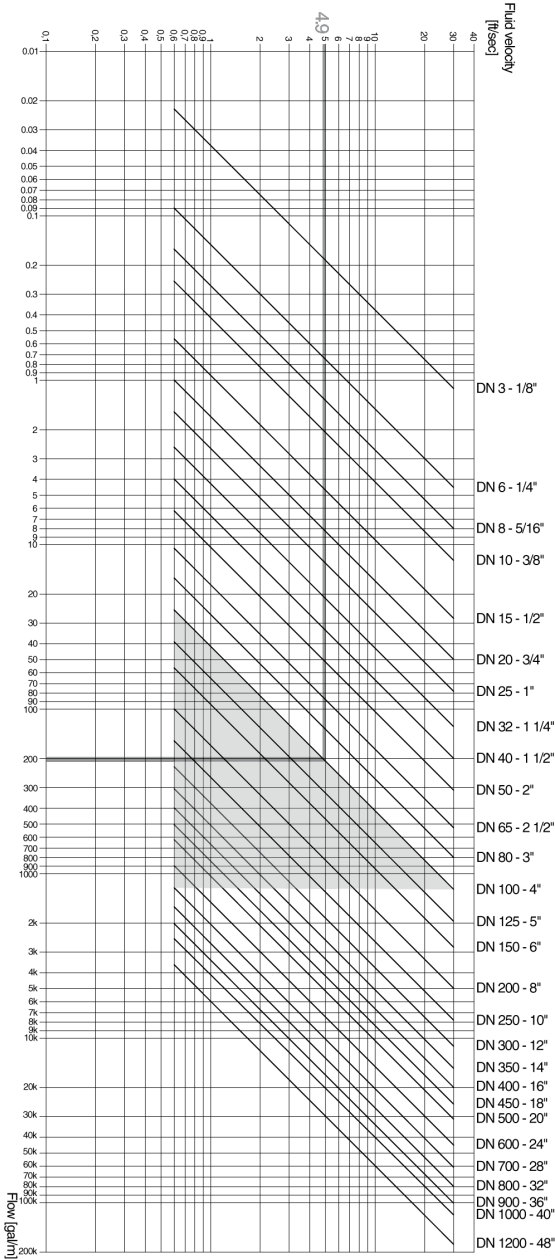

Pipe system

- To ensure a laminar flow without turbulence upstream of the MagFlux® flow sensor, the flow sensor must be mounted in a location which is free from interfering elements like valves, Ts, bends, pumps, etc. For that reason, the MagFlux® flow sensor must be mounted in a straight pipe at a distance from interfering elements of minimum $3 \times \text{DN}$ upstream and minimum $2 \times \text{DN}$ downstream.

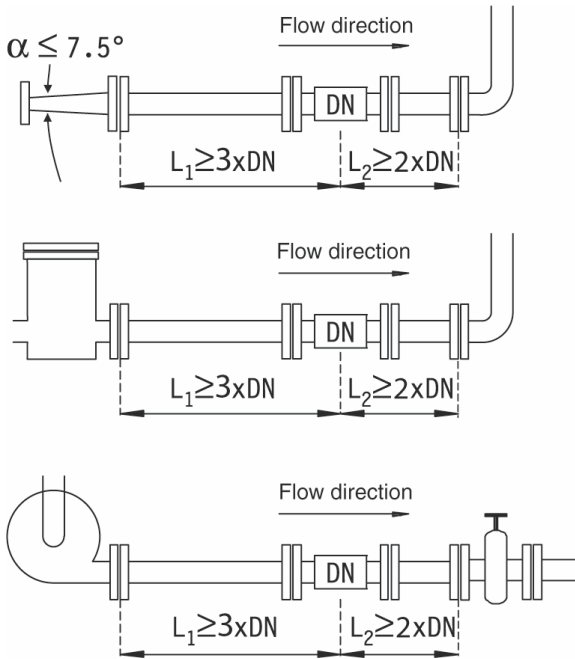

Important: Valves should always be mounted on the downstream side of the MagFlux® flow sensor!

Important: When installing a magnetic inductive flow meter, it is important to comply with the installation criteria described here:
The mentioned respect distances for up/downstream flow respectively, are minimum requirements. If your installation has an already turbulent flow profile due to bends, valves, plug-in fittings etc. in the pipe installation, it may be necessary with a longer respect distance than stated in the data sheet. For the meter to comply with its measuring accuracy, these respect distances apply both before and after the meter. If in doubt about the installation and the respective respect distances, please contact support. We are happy to assist and advise on

the optimal location of the flow meter according to your application.

2. If it becomes necessary to use reducers, the inner angle must not exceed 7,5°.

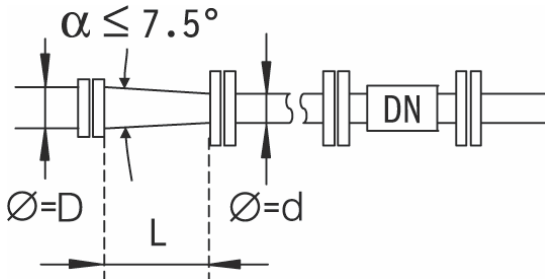

The minimum length to keep the angle below 7,5° can be checked by means of the formula below:

$$L = (D - d) \times 7.63$$

where **D** is the large diameter and **d** the small diameter of the reducer.

Example: If a MagFlux® flow sensor in dimension DN 80 is mounted downstream of a 100 mm pipe, the reducer must then have a length of minimum 152,6 mm in order to keep the inner angle below 7,5°.

3. Flange connections must be assembled concentrically on both the upstream and the downstream side. Measuring accuracy will be affected by turbulence in the liquid from poorly made connections.

Important: Gaskets and grounding rings must also be mounted concentrically!

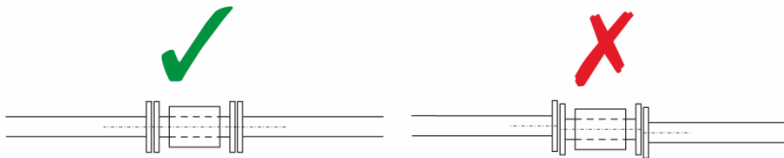

4. The MagFlux® flow sensor should always be filled with liquid. For that reason, the flow sensor must not be mounted at the highest point of the pipe system or in free outlets, where gravity could empty or partially empty the pipe.

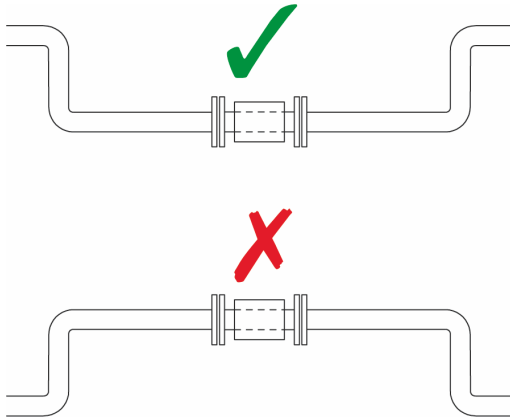

5. The MagFlux® flow sensor can be mounted vertically or horizontally. If the flow sensor is mounted vertically, the flow direction should always be upwards. In that way, the effect from possible bubbles in the liquid will be significantly reduced, just as it will ensure that the flow sensor is always filled with liquid. In case the liquid is carrying particles, for example when measuring sludge, sewage, etc., the flow sensor must be mounted vertically.

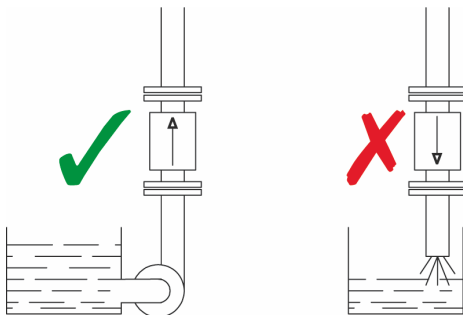

6. When mounting horizontally in pipes with free downstream outlet, the MagFlux® flow sensor should be mounted such that it will always be filled with liquid, for example in a bend situated lower than the height of the outlet. In case the liquid is carrying particles, e.g. when measuring sludge, sewage etc. the flow sensor must be mounted vertically.

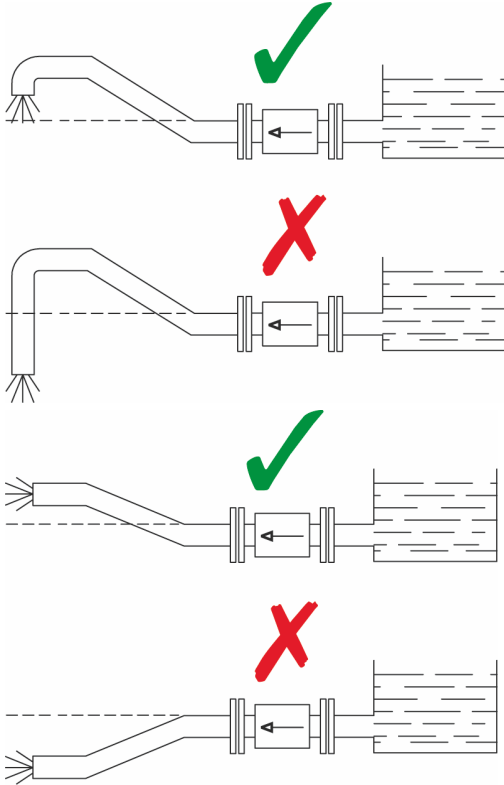

7. When mounting horizontally the MagFlux® flow sensor can be rotated max. +/- 45° seen from the connection end. If the flow sensor is rotated more than 45°, one of the electrodes may not be in full contact with the liquid.

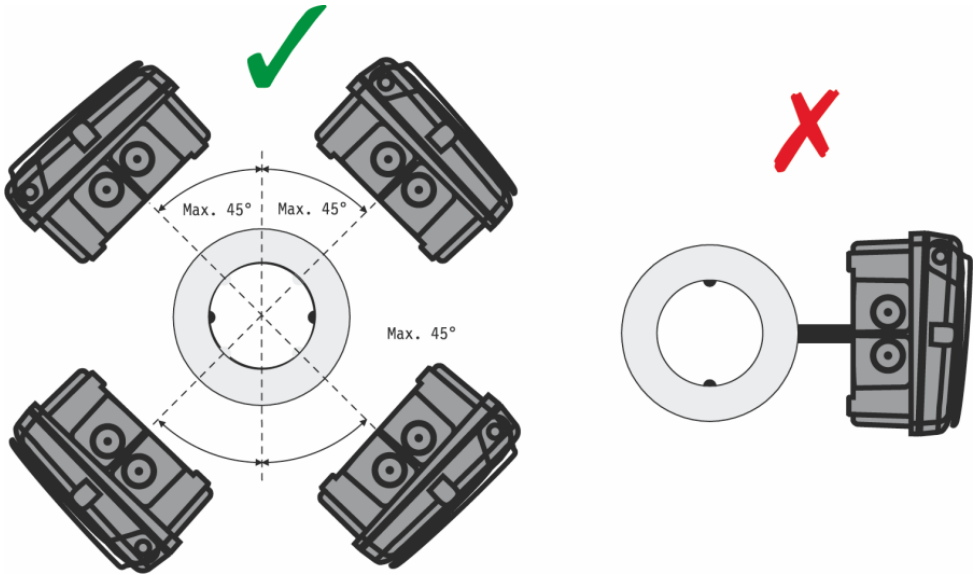

Pipe system - MagFlux Q special conditions

For MagFlux® Q, a special design allows using a short build-in construction which provides a very accurate flow measurement even at minimum one pipe diameter of straight pipe upstream and one pipe diameter of straight pipe downstream from the centre of the flow sensor.

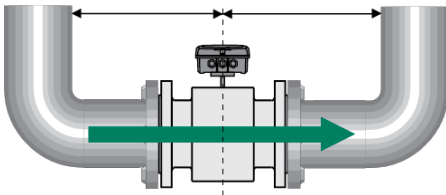

At 1 x diameter before and after the sensor there will be an accuracy of up to 0,5%.

Cabinet mounted on the flow sensor

The cabinet is mounted on the flow sensor with four pcs. 6x12 hex cap screws.

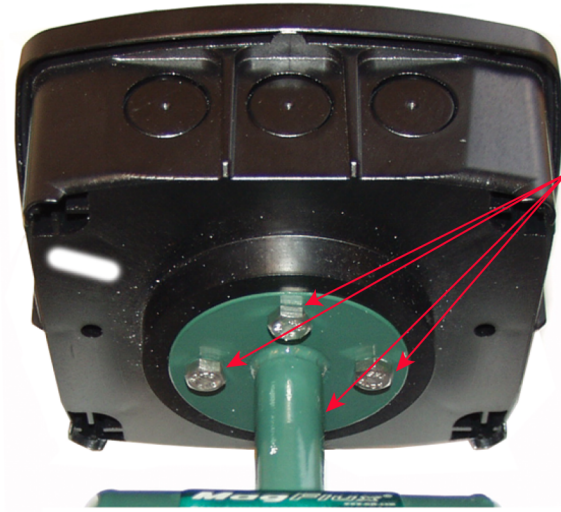

Potential equalization and grounding

Type 7100/7200/8200 in conductive pipes

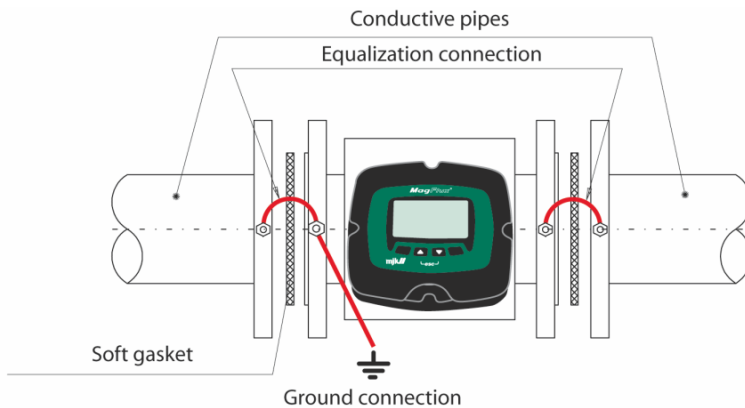

Note! The MagFlux® flow sensor **must** be connected to an effective ground connection, and the wire dimension must be at least 1.5 mm².

Note! Does not apply to the MagFlux® Q.

MagFlux® in conductive pipes, MagFlux® Q

Note! Does not apply to the MagFlux® Q.

Type 7100/7200/8200 in non-conductive pipes

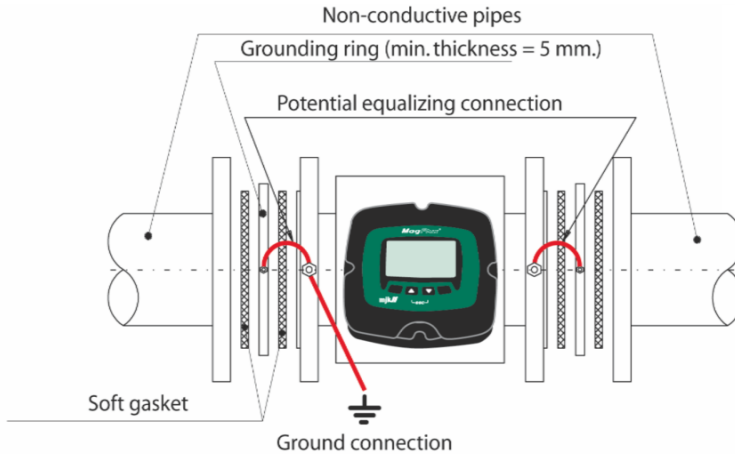

Note! The MagFlux® flow sensor **must** be connected to an effective ground connection, and the wire dimension must be at least 1.5 mm^2 .

Note! Does not apply to the MagFlux® Q.

MagFlux® in non-conductive pipes, MagFlux® Q

Note! Does not apply to the MagFlux® Q.

Cathodic protection

Type 7100/7200 in conductive pipes

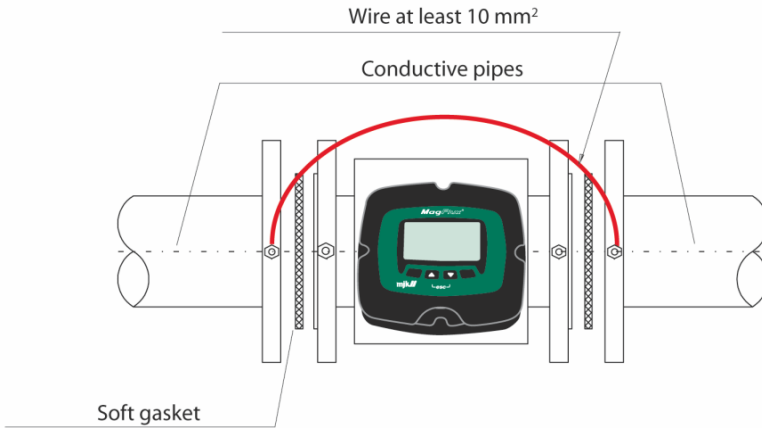

Note! The Sensor **must** be isolated from the cathodic protected pipes, this is done by using insulated bolts and nylon washers.

Type 7100/7200 in non-conductive pipes

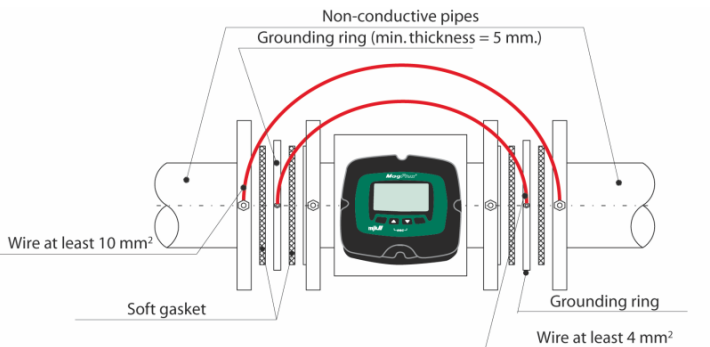

Note! The Sensor **must** be isolated from the cathodic protected pipes, this is done by using insulated bolts and nylon washers.

Flow converter

Electrical mounting

Warning: The MagFlux® flow converter/flow sensor must not be mounted in explosion hazardous areas!

Loosen the four screws (position indicated by arrows) and remove the display unit to gain access to the terminals.

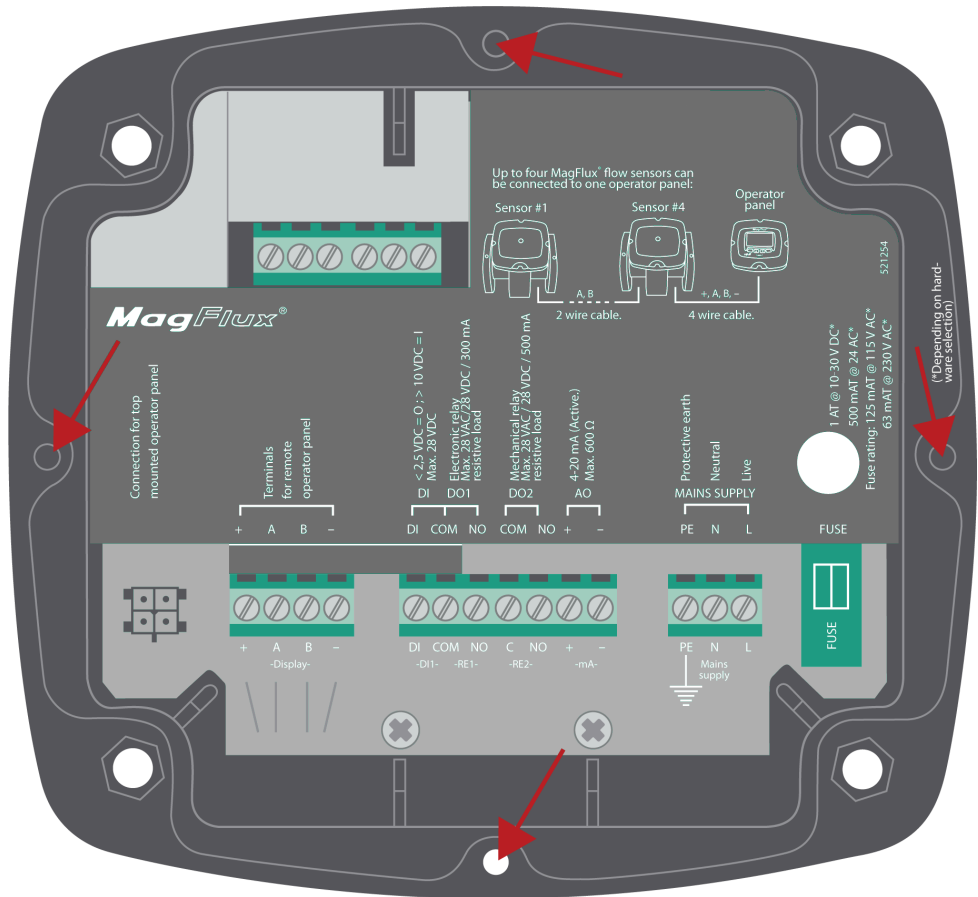

Power supply

The MagFlux® flow converter must be supplied from a properly fused mains outlet, a 24 volt AC outlet, or a 10 - 30 V DC power supply/battery.

Power Supply 230 V AC, 115 V AC or 24 V AC

Terminal	Designation
PE	Protective ground
N	230 / 115 / 24 V AC neutral
L	230 / 115 / 24 V AC live

Power Supply 10 - 30 V DC

Terminal	Designation
PE	Protective ground
-	DC neutral
+	DC live

The internal fuse ratings are:

Internal Fuse Ratings

Voltage	Rating	Order no.	Dimension
230 V AC	63 mA T	550030	5 x 20 mm
115 V AC	125 mA T	550035	5 x 20 mm
24 V AC	500 mA T	550049	5 x 20 mm
10 - 30 V DC	1.0AT	550051	5 x 20 mm

The technical specifications/requirements for a 10 - 30 V DC power supply/battery are:

Technical Specifications for 10 - 30 V DC Power Supply

Power consumption without display	< 5 W
Power consumption with display	< 8 W
Peak start current @12 V DC, 1 second	Approx. 1,5 A
Peak start current @24 V DC, 1 second	Approx. 1 A

Change power supply voltage 230/115 V AC

To change the input mains voltage from 230 VAC to 115 VAC (or vice verse) proceed as follows:

1. Loosen the four screws on the front and lift out the display (see [Electrical mounting \(see page 31\)](#)).
2. Note down the color and position of the wires in the terminal blocks, and loosen the terminal screws.
3. Unscrew the two screws that hold the metal cover and then remove it.
4. Unscrew the four screws that hold the mother PCB (the printed circuit board with all the electrical components).
5. Remove the mother PCB and look at the back side. This is what you should see (230 V AC configuration):

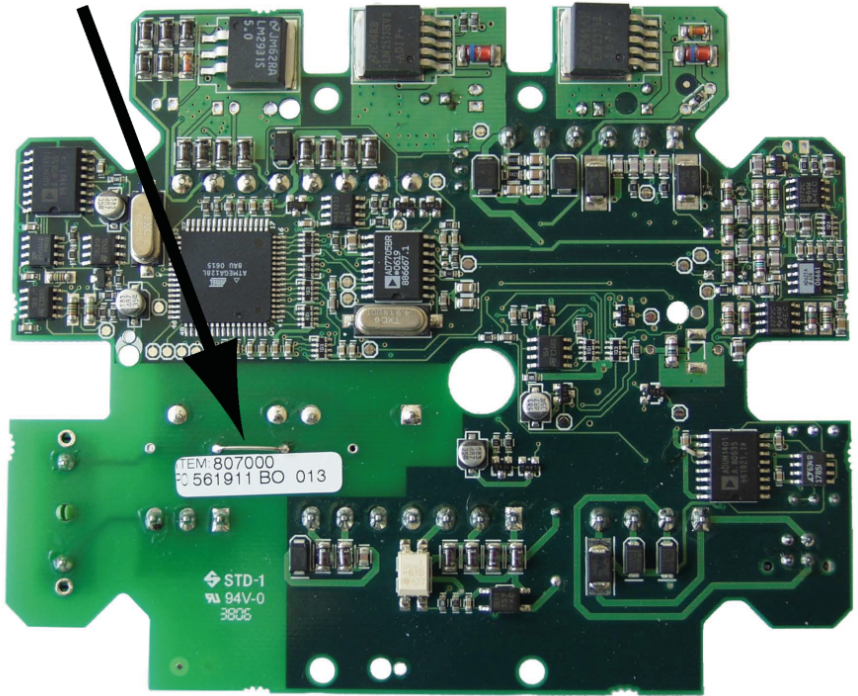

6. Unsolder and remove the jumper indicated by the arrow.

7. Look at the following picture to see where two new jumpers must be inserted (115 V AC configuration):

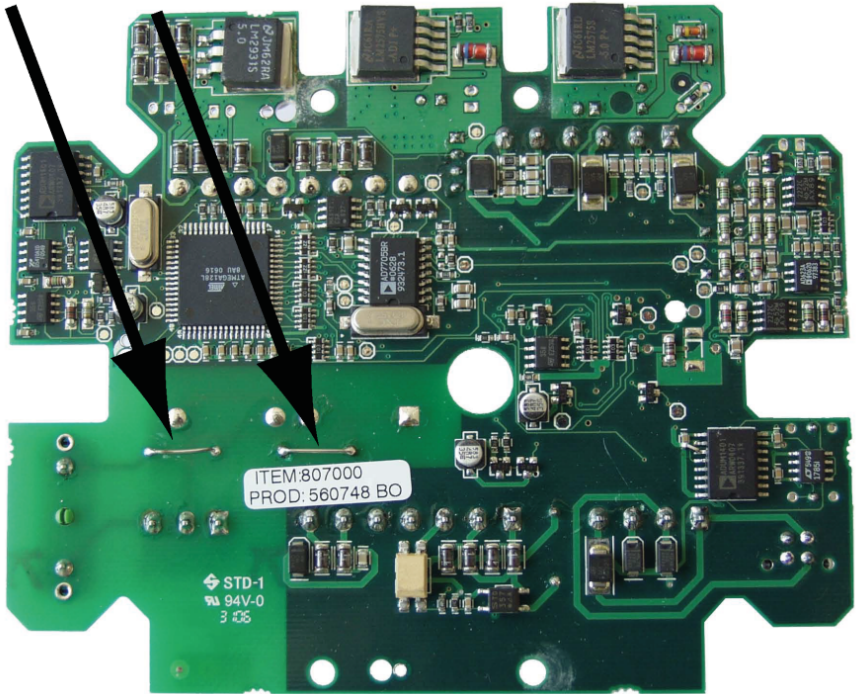

8. Insert and solder two jumpers (wires) in the positions indicated by the arrows.
9. Turn around the PCB and replace the 63 mA fuse on the right side with a 125 mA fuse (or vice versa going from 115 V AC to 230 V AC).
10. Re-insert the PCB and re-assemble the flow meter (see also steps 4, 3, 2 and 1).

Analogue output

The analogue output is an active output with a max. load of 600Ω.

Analogue Output		
Terminal		Designation
AO	+	4-20 mA
AO	-	4-20 mA

The analogue output can be programmed for indication of:

- Flow forward
- Flow reverse
- Forward and reverse (12 mA = 0)
- Forward and reverse (4 mA = 0)
- Not in use

See details in sections [mA output](#) (see page 70), [Flow forward](#) (see page 71), [Flow reverse](#) (see page 72), [Forward & rev. \(12mA=0\)](#) (see page 73) and [Forward & rev. \(4mA=0\)](#) (see page 74).

Digital outputs

MagFlux® has two digital outputs - DO 1 with an opto (light triggered) relay and DO 2 with a mechanical relay.

They can both be programmed for the following functions:

- high and low flow alarms
- pulse output for counters **R Totalizer Forward, Reverse** and **Sum**.
- batch 1 and batch 2 counters
- empty pipe alarm
- flow direction indication

Opto Relay (DO1)		
Terminal		Designation
DO 1	Com	Max. 28 VAC/ 28 VDC /300 mA
DO 1	NO	

Mechanical Relay (DO2)		
Terminal		Designation
DO 2	Com	Max. 28 VAC/ 28 VDC /500 mA
DO 2	NO	

DO 1 shares the common terminal (Com) with DI.

See also application examples in [Appendix G. Digital input/output connections](#) (see page 151).

Digital input

MagFlux® has one digital input which is activated with a voltage higher than 10 V DC and deactivated with a voltage lower than 5 V DC.

Digital Input		
Terminal		Designation
DI	Com	
DI		Max. 30 V DC

The digital input (DI) can be programmed for the following functions:

- start and pause batch 1 and batch 2 counters
- reset counters **R Totalizer Forward** and **Reverse**
- reset counter **R Totalizer Sum**

DI shares the common terminal (Com) with DO 1.

See also application examples in [Appendix G. Digital input/output connections](#) (see page 151).

Local (compact) flow sensor

Connect the compact (local) flow sensor to the flow converter with the wires coming from the flow sensor as shown below.

Compact Flow Sensor			
Terminal	Signal	Designation	Colour from sensor
1 	Liquid GND	Built-in liquid ground electrode	Black/shield
2	E1	Electrode	Red
3	E2	Electrode	White
4	GND	Ground	Black
5	L1	Coil	Blue
6	L2	Coil	Brown
7, 8 and 9	not used		

Remote flow sensor

Connect the remote flow sensor to the flow converter with the sensor cable.

Important: Do not use other cable types!

Important: Terminals 1 and 4 must be shunted!

The extension cable length between converter and sensor must under normal circumstances not exceed 50 meters. Power lines running in parallel and noisy environments may reduce the max. length to less than 50 meters. Consult us for advice and guidance.

Remote Flow Sensor			MagFlux® Sensor Cable	
Terminal	Signal	Designation	Color before March 2011	Color from March 2011
1 	Liquid GND	Shield	-	-
2	E1	Wire pair no. 1	Red	Red
3	E2	Wire pair no. 1	White	White
4	GND	Wire pair no. 3	Black	Black
5	L1	Wire pair no. 2	Green	Blue
6	L2	Wire pair no. 2	White	Brown
7, 8 and 9	not used			

Converter connection board - local

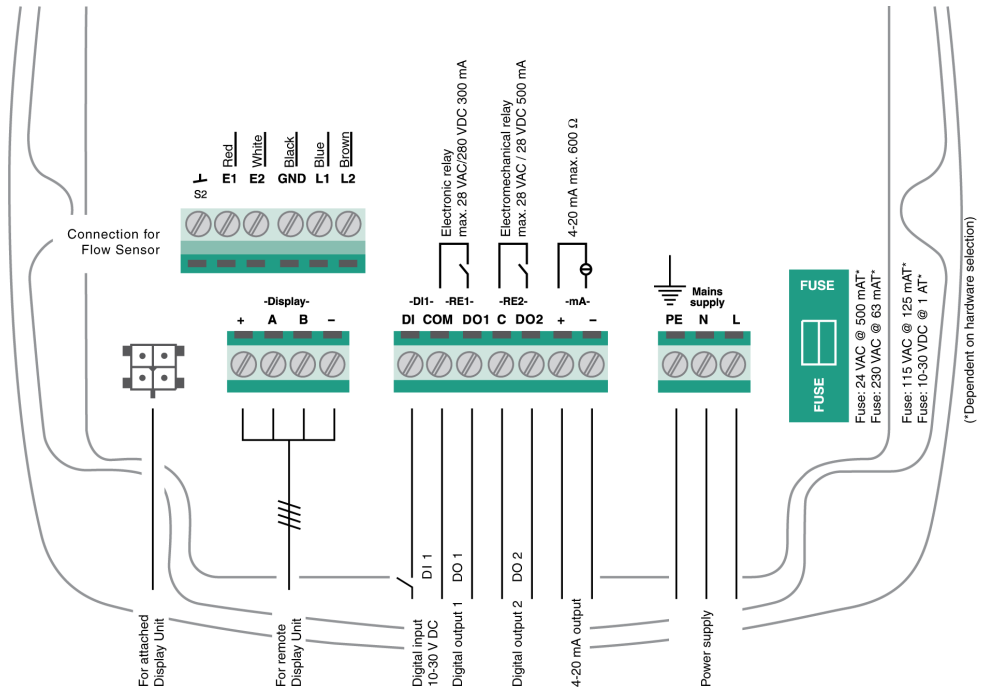

MJK Connection board - remotely mounted converter

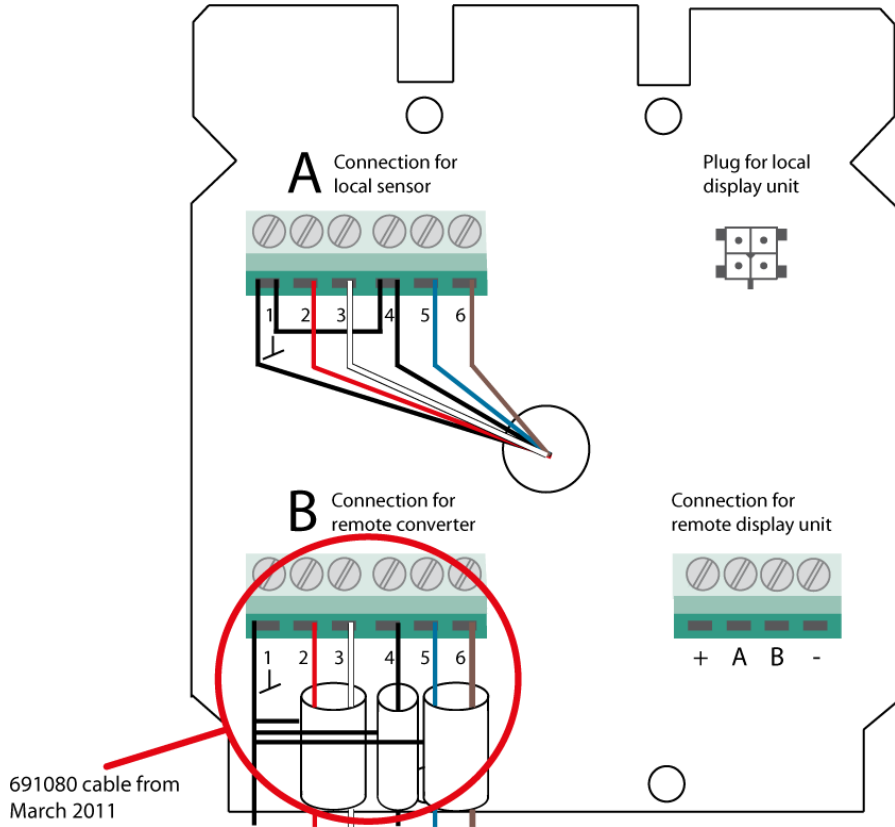

Note! Before March 2011, the blue wire for terminal 5 was green and the brown wire for terminal 6 was white.

Note! After November 2018, the latch between terminal A, 1 and 4 is build into the PCB.

System configuration examples

MJK compact converter and display unit on flow sensor

Configuration: The MagFlux® converter and display unit is mounted directly on the MagFlux® flow sensor.

Order numbers for this configuration:

- 207xxx MagFlux® Flow Sensor
- 207920 MagFlux® Converter with display unit for sensor mounting

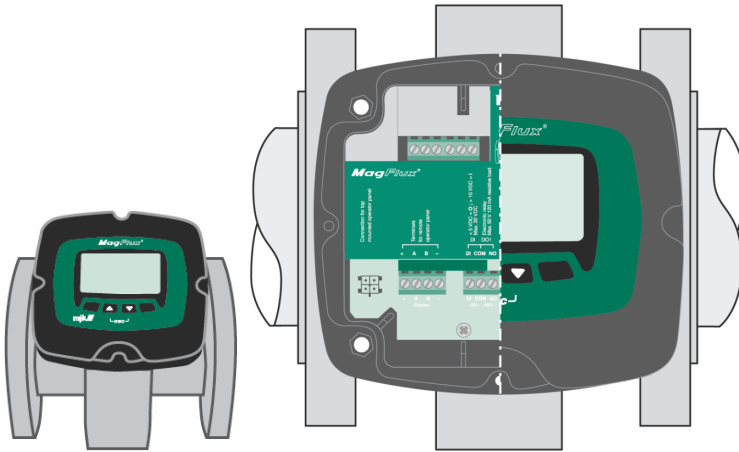

207920 consists of:

- 207940 Display Unit
- 807000 Converter PCB
- 500214 Field Cabinet bottom part for sensor mounting

MJK remote converter with connection box on flow sensor

Configuration: The MagFlux® converter and display unit is remote mounted, for example when the sensor must be IP 68 down-proof.

.

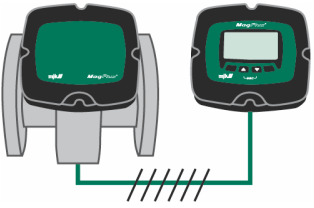
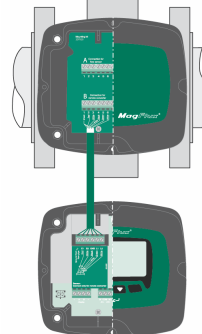
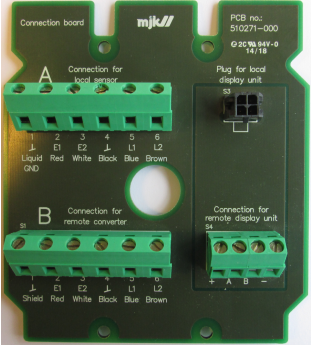
<p>Order numbers for this configuration:</p> <ul style="list-style-type: none"> • 207xxx MagFlux® Flow Sensor • 207925 MagFlux® Converter with Display Unit for wall mounting • 691080 MagFlux® Sensor cable • 579035 MagFlux® Gel Potting Kit IP68 	
<p>207925 consists of:</p> <ul style="list-style-type: none"> • 207940 Display Unit • 807020 MagFlux connection PCB (see picture below) • 820050 Blind Lid • 800070 Cabinet bottom part for sensor mounting • 800075 Cabinet bottom part for wall mounting 	
<p>PCB</p>	

Wiring schematic #1

Wiring schematic for MJK remote converter with connection box on flow sensor (see page 42).

Flow sensor			
Connect one end of the cable to the flow sensor as described in the table below. All three shields are twisted and connected in slot 1. The white lead in pair no. 3 is not used.			
B Connection for remote converter			
Terminal	Signal	Wire	Color
1	GND	Shield	-
2	E1	Pair 1	Red
3	E2	Pair 1	White
4	GND	Pair 3	Black
-	-	Pair 3	-
5	L1	Pair 2	Blue
6	L2	Pair 2	Brown
7,8,9	Not used		
Remote converter (and display unit)			
Connect the other end of the cable to the remote converter as shown to the right. The 1 Shield lead goes into Ground from flow pipe, the 2 Red lead goes into E1 Red, the 3 White lead into E2 White, and so on.			

MJK remote display and multiple converters wiring

Configuration: Two locally mounted MagFlux® flow sensors and converters with blind lid and one remotely mounted display unit. The communication between the sensors and the display unit is executed on shielded twisted 2- and 4-wire cables using the Modbus® communication protocol on RS-485.

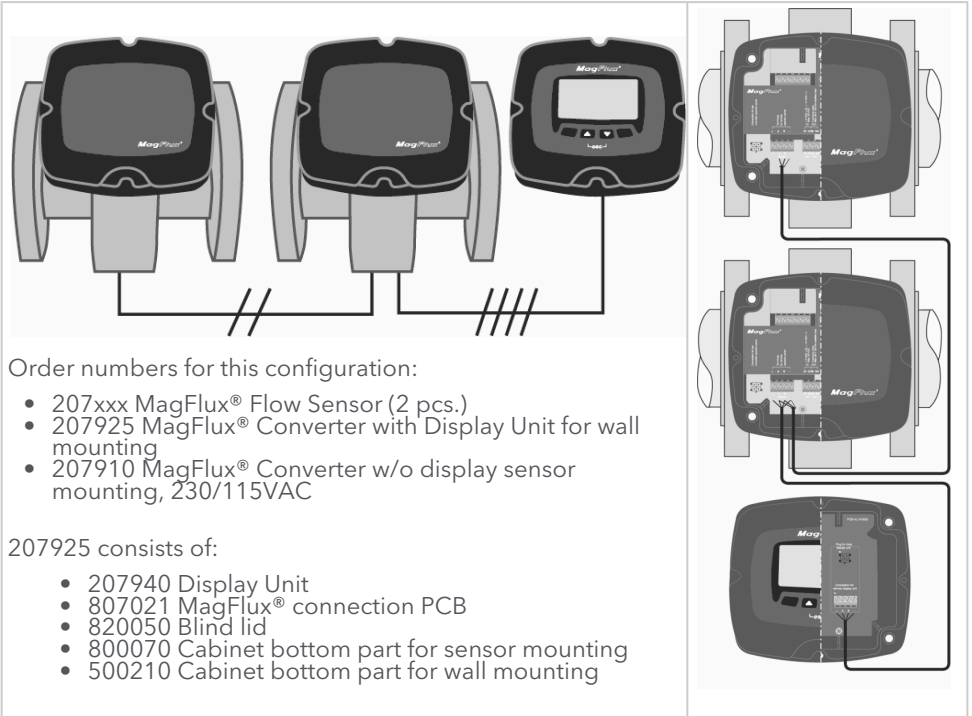

Note: The total maximum cable length for the 2- and 4-wire shielded twisted cables is 1000 meters.

Wiring schematic #2

Wiring schematic for MJK remote display and multiple converters wiring (see page 44).

Local flow sensor 1

2-wire twisted shield cable: Connect lead **1** to slot **A**, lead **2** to slot **B** and shield to slot **-**.

Local flow sensor 2

2-wire twisted shield cable: Connect lead **1** to slot **A**, lead **2** to slot **B** and twisted shield to slot **-**.

4-wire twisted shield cable: Connect lead **1** to slot **A**, lead **2** to slot **B**, lead **3** to slot **+** and lead **4** and twisted shield to slot **-**.

Remote display unit

4-wire twisted shield cable: Connect lead **1** to slot **A**, lead **2** to slot **B**, lead **3** to slot **+** and lead **4** and twisted shield to slot **-**.

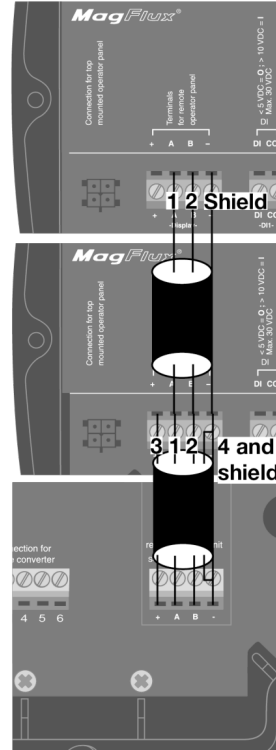

Startup

MJK initial checks

Before switching power on for the MagFlux®, the following steps must be checked.

1. The local mains power supply voltage corresponds to the voltage printed on the identification label of the MagFlux® flow converter.
2. All electrical connections are made in accordance with the electrical connection diagram shown in [Converter connection board - remote](#) (see page 41).
3. All terminal screws are tightened.
4. All cable glands are tightly secured.
5. All grounding connections are made in accordance with the instructions in [Potential equalization and grounding](#) (see page 28).

Initial flow measurement

1. Make sure that the MagFlux® flow sensor is completely filled with liquid.
2. Turn on power to the MagFlux® flow converter and wait one minute.
3. Verify or enter the calibration code of the MagFlux® flow sensor in the **Converter Setup/Service Menu/Sensor Calibration Code** menu (see also [Service menu](#) (see page 97)). If the entered calibration code is incorrect read the correct calibration code on the converter as explained in section on product identification.

Flow direction check

1. Allow free flow through the sensor.
2. Check on the MagFlux® display unit screen that the flow value increases. If the value goes negative, check that the [Flow direction option](#) (see page 92) is set correctly and/or check the electrical connections on the flow sensor.

Language selection

1. The default display language is English (GB). If another language is required, proceed with step 2.
2. From the **Main Menu**, select [Display Setup](#) (see page 108).
3. Select [Language](#) (see page 109) and chose the required language.

MJK display read-out, one connected unit

All MagFlux® display read-outs are illustrated and described in this manual. Section [MagFlux® menus \(see page 53\)](#) gives a detailed description of the displays shown during setup, configuration and normal operation. A 5-line LCD screen displays symbols and the actual status during setup, configuration, servicing and normal operation (see also [Specify main screen \(see page 54\)](#)).



The display shown above will, in the remaining parts of this manual, be stylized to appear like this:

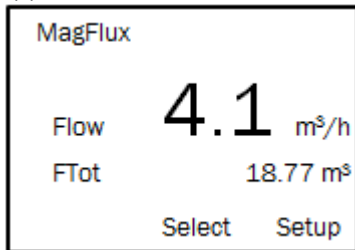

Display read-out, several connected units

When several units are interconnected, for example an Oxix® dissolved oxygen transmitter and MagFlux® flow meter with different names and Modbus ID numbers, a **Display Overview Menu** is available at top level (press **Back** repeatedly):

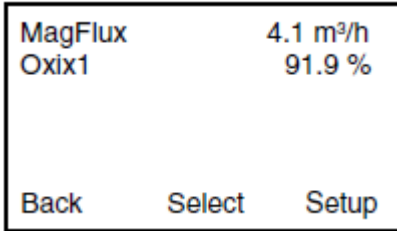

All connected units are displayed and sorted by their ID numbers, and consequently each unit can be selected and set up as required:

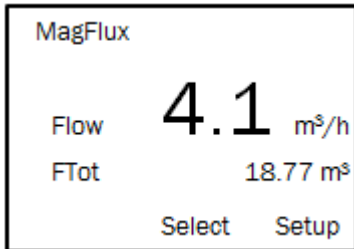

or

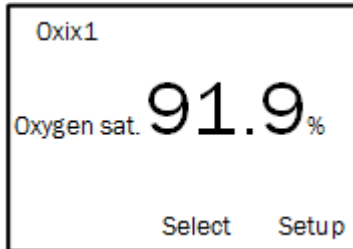

Important: More connected units can only be managed as described above if each unit has been assigned a unique name and Modbus ID number. See [Modbus](#) (see page 111) for details.

MJK display keys

The keys and the soft keys (variable key functions determined by the display firmware) are used for initial programming and normal operation of the flow meter. The function(s) of the four available keys is displayed at the bottom of the display. The symbols and actual functions are described in detail in the sections that describe the individual menus.

Contrast adjustment

Adjust the display contrast by pressing the two outmost keys simultaneously (indicated by the keys) and press the up/down keys as required.



Save the new setting by pressing the two outmost keys simultaneously.

System reset

You can reset and refresh all system displays and key combinations by pressing all four keys simultaneously. This feature is especially useful during for example a service call, where the display language (Dutch, Danish, etc.) cannot be understood by the service person. A system reset immediately sets the display language to (GB) English. The system reset must not be confused with the ultimate **Recover factory settings** (see [Factory settings](#) (see page 116)) which deletes all local configurations/settings and replaces them with default factory settings.

Initial setup

Initial setup is normally performed by our personnel and is required to get started with the MagFlux® flow meter. A unique sensor calibration code provides the MagFlux® flow converter with information about flow sensor number, nominal diameter and calibration data.

If changes to the unique sensor calibration code are needed following physical installation and initial setup, the **Sensor Calibration Code** menu must be addressed. A

password is not required to enter or change the sensor calibration code. Toggle through the displayed digits with the right-arrow key when prompted for a password and press **OK**.

1. Press the **Setup** key on the display (see below) to enter the MagFlux® main menu.

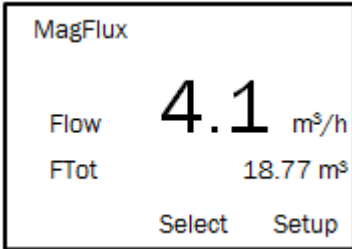

2. Press the up/down keys to highlight the required menu line (here: **Converter Setup**) and press **OK**.

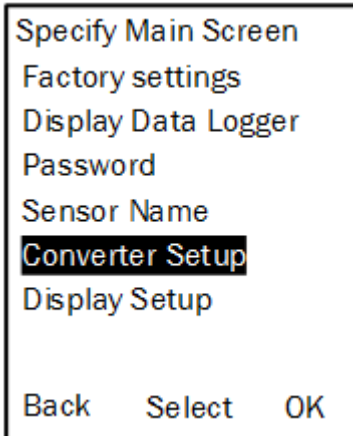

3. Select **Service Menu**, enter the password (the default password is "00000" (five zeros)) in **Sensor Calibration Code**.

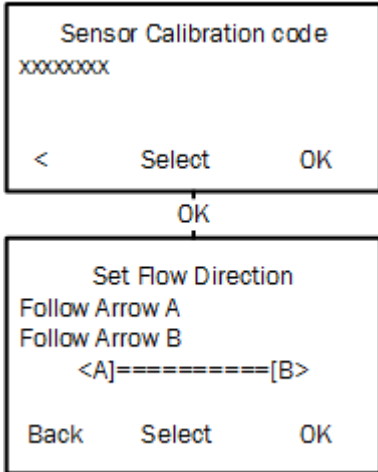

4. Enter the calibration code read from the flow sensor label (or pass through or change the displayed calibration code) and press **OK**. See also details regarding the calibration code in the section on product identification.
5. Select the correct flow direction in the **Set Flow Direction** menu and press **OK**. The MagFlux® is now configured with default settings and is ready for use.

Note: If the MagFlux® sensor has not been pre-configured from the factory with a sensor calibration code, the calibration code procedure is somewhat different from the just mentioned.

See the following steps to configure a non-configured sensor with a calibration code.

1. Apply power to the MagFlux® sensor.
2. When the **Sensor Calibration Code** menu appears (see above), enter the calibration code read from the flow sensor label and press **OK**.
3. Select the correct flow direction from the **Set Flow Direction** menu and press **OK**.
4. Sensor calibration code configuration is now finished, and you are returned to the main menu.

MagFlux® menus

All the MagFlux® menus and sub menus are shown and described in the following sections. Continuous overviews of the menu and sub-menu structures are available from the appendix.

Main menu

1. Press the **Setup** key on the MagFlux® display (see below) to enter the MagFlux® main menu:

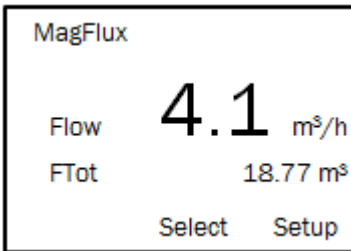

2. The MagFlux® main menu contains a number of sub menus:

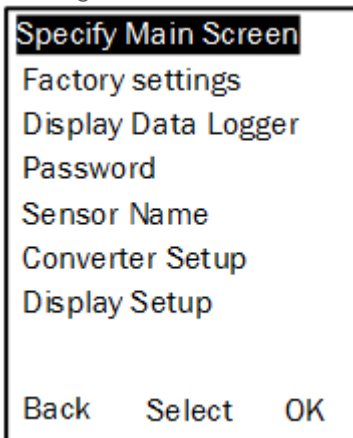

3. Press the up/down keys to highlight the required menu line (here: **Specify Main Menu**) and press **OK**.

Specify main screen

The **Specify Main Screen** menu allows you to customize the MagFlux® display to suit your requirements. You can add and remove the five available display lines and configure them individually.

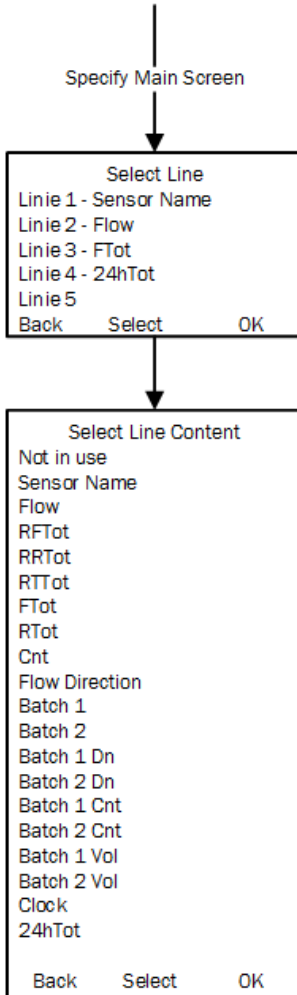

1. Press the up/down keys to highlight the required menu line and press **OK**.
2. Press the up/down keys to highlight the required option and press **OK**.

The available options are:

- **Not in use:** The line will not be used. The set free space will be used by the other lines.
- **Sensor Name:** The actual sensor name - for example, a number, a location, a name or a function - will be displayed.
Note: The actual sensor name is defined later on in the **Set Sensor Name** menu, see [Set sensor name](#) (see page 64).
- **Flow:** Actual flow rate (in units chosen in the menu for primary units).
- **RFTot:** Resettable Forward Totalizer counter 32bit (unit L) 4 294 967 295 L
- **RRTot:** Resettable Reverse Totalizer counter 32bit (unit L) 4 294 967 295 L
- **RTTot:** Resettable Total Totalizer counter 32bit (unit L) 2 147 483 647 L (+/- half of Tot)
- **FTot:** Forward Totalizer counter 64bit (unit mm³) 18 446 744 073 709 551 615 mm³
- **RTot:** Reverse Totalizer counter 64bit (unit mm³) 18 446 744 073 709 551 615 mm³
- **Cnt:** Totalizer sum Counter 64bit (unit mm³) 9 223 372 036 854 775 807 mm³ (+/- half of Tot)
- **Flow Direction:** Flow direction **A** or **B** will be displayed
- **Batch 1:** Timer for batch volume 1
- **Batch 2:** Timer for batch volume 2
- **Batch 1 DN:** Displays the missing amount of Batch volume 1 (DN = down)
- **Batch 2 DN:** Displays the missing amount of Batch volume 2 (DN = down)
- **Batch 1Cnt:** Batch 1 Counts (number of batches)
- **Batch 2 Cnt :** Batch 2 Counts (number of batches)
- **Batch 1 Vol:** Batch 1 Volume
- **Batch 2 Vol:** Batch 2 Volume
- **Clock:** Time and date
- **24hTot:** The total flow for 1 day (24 hours) logged at midnight (12 PM).

The size of the display lines will automatically increase or decrease as the number of display lines is removed or added to maximize the field of view for the measured values.

MJK factory settings

The **Factory Settings** menu resets the display to default settings, to metric settings or to US settings.

Note: The converter settings are not changed from this menu. Converter settings are covered in [Converter setup](#) (see page 65).

1. Press the up/down keys to highlight the required menu line (here: **Factory Settings**) and press **OK**.

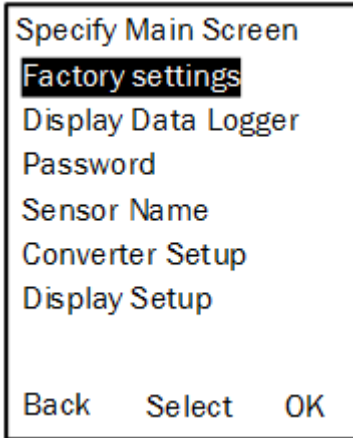

2. Press the up/down keys to highlight the required option and press **OK**.

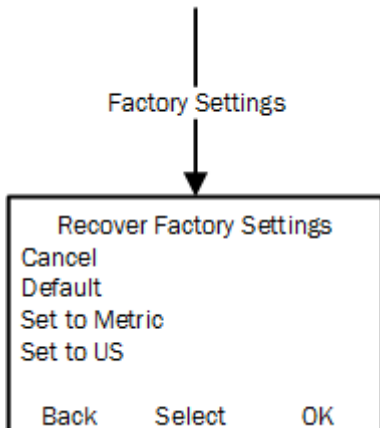

The available options are:

- **Cancel:** Exit the menu without changes.
- **Default:** When **Default** is selected, the following settings are not affected and remain as chosen by the user:
 - **Sensor Name**
 - **Device ID**
 - **Flow Direction**
 - **DN, size**
 - **Calibration**
 - **Calibration Code**

Per default, the in- and outputs are not activated from the factory. Activate the in- and outputs by configuring the functions with, for example, the default values shown in the following tables:

- MagFlux Default DI/DO Settings
- MagFlux Default 20 mA Settings

MagFlux Default DI/DO Settings		
Digital Output 1 (opto) - DO1	Digital Output 2 (mech.) - DO2	Digital Input - DI
Counter R Totalizer Forward	Counter R Totalizer Forward	RESET R Totalizer Forward
Counter R Totalizer Reverse	Counter R Totalizer Reverse	RESET R Totalizer Reverse
R Totalizer Sum	R Totalizer Sum	RESET R Totalizer Sum
Batch Counter 1	Batch Counter 1	Start / Pause Batch counter 1
Batch Counter 2	Batch Counter 2	Start / Pause Batch counter 2
Low Flow	Low Flow	
High Flow	High Flow	
Flow Direction	Flow Direction	
Empty Pipe	Empty Pipe	

Note: The same function can not be on assigned to both relays.

MagFlux Default 20 mA Settings			
Metric		US	
DN [mm]	Flow [m³/h]	Size	Flow [GPM]
15	5	½"	30
20	10	¾"	50
25	20	1"	75
32	30	1¼"	100
40	50	1½"	200
50	75	2"	300
65	100	2½"	500
80	200	3"	800
100	300	4"	1000
125	400	5"	2000
150	600	6"	3000
200	1000	8"	5000
250	2000	10"	7700
300	2500	12"	10000
350	3000	14"	10000
400	4500	16"	20000
450	6000	18"	25000
500	7000	20"	30000
600	10000	24"	40000

MagFlux Default 20 mA Settings			
Metric		US	
DN [mm]	Flow [m ³ /h]	Size	Flow [GPM]
700	15000	28"	60000
800	20000	32"	80000
900	25000	36"	100000
1000	30000	40"	100000
1200	40000	48"	200000

- **Set to metric:** All converter-related units can be set to the following units (default values in bold and italics):

Flow Unit	Tota-lizers						
m ³ /sec	RFTot	RRTot	RSTot	FTot	RTot	Cnt	
l/sec	l	l	l	<i>l</i>	<i>l</i>	<i>l</i>	
l/min	hl	hl	hl	hl	hl	hl	
l/h	kl	kl	kl	kl	kl	kl	
m ³ /h	<i>m³</i>	<i>m³</i>	<i>m³</i>	m ³	m ³	m ³	

- **Set to US:** All converter-related units can be set to the following units (default values bold and in italics)

Flow Unit	Tota-lizers						
ft ³ /h	RFTot	RRTot	RSTot	FTot	RTot	Cnt	
MGD	ft ³	ft ³	ft ³	<i>ft³</i>	<i>ft³</i>	<i>ft³</i>	
GPM	<i>gal</i>	<i>gal</i>	<i>gal</i>	gal	gal	gal	
	MG	MG	MG	MG	MG	MG	

Data logger

MagFlux® provides a data logger with a capacity of approx. 345.000 entry points. See **Appendix E.** about test certificate for examples and descriptions of log files. The data logger operates after the FIFO principle (First In, First Out). If the data logger is full and new data are coming in, the oldest data are discarded.

1. Press the up/down keys to highlight the required menu line (here: **Display Data Logger**) and press **OK**.

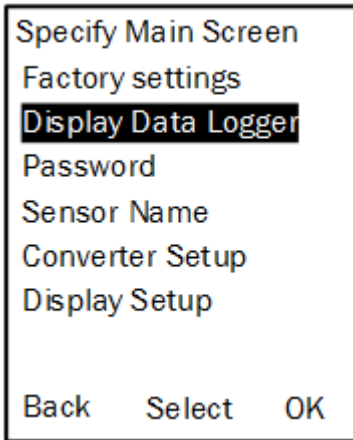

2. Select the digits one by one with the left/right keys and set the values with the up/down keys.

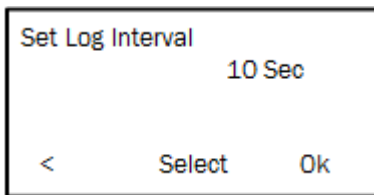

3. Continue until all digits have been set and press **OK**. The log interval can be set in intervals from 10 sec. up to 9999 sec.

The data log contains:

- Date
- Time
- Flow values

In case of a power failure, the MagFlux® data logger continues when power returns. If more MagFlux® converters are connected to one MagFlux® display unit, each MagFlux®

converter has its own individual log interval and can be sorted. All MagFlux® converters share the same memory of 345.000 entry points.

The log data can be shown on the MagFlux® display unit or be stored in an external CSV file. The **Field Link** software is needed for transfer of data into CSV file format via the USB port in the MagFlux® display unit. The format can be read in, for example Microsoft® Excel®, (see **Appendix B.** about **Field Link** software for details).

An example of the log capacity of one sensor versus the time interval is shown in the following table.

Log interval		Log capacity	
Seconds	Minutes	Hours	Days
10	-	958	39
30	-	2875	119
-	1	5750	239
-	5	28750	1198
-	10	57500	2395
-	30	172500	7187
-	60	345000	14375

Graph display

The content of the **Data Logger** can be displayed on the MagFlux® display unit by pressing the up/down keys simultaneously (**esc**), highlighting **Flow** and selecting **Graph**.



The MagFlux® display unit then shows the **Graph** screen. To return to the **Main Menu**, select **esc** by pressing the up/down keys simultaneously.

The Y axis is automatically scaled according to the Q_{max} of the mA output.

Double-arrow keys jump forward and backward one screen frame at a time. Single-arrow keys move the cursor forward and backward on the screen. The actual values at the cursor position is shown at the bottom of the screen.

Password

A password provides (and prevents) access to all settings in the display and converter unit. The code consists of a numeric 5-digit code between 0 and 65535. If your current password is lost or forgotten, the password protection can be overruled with the code **01750**.

1. Press the up/down keys to highlight the required menu line (here: **Password**) and press **OK**.

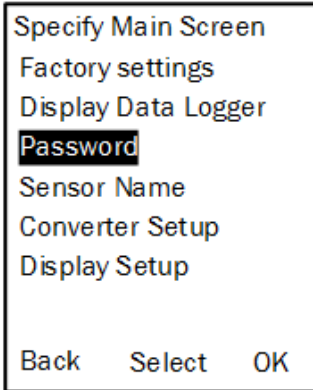

2. Press the up/down keys to highlight the required menu line and press **OK**.

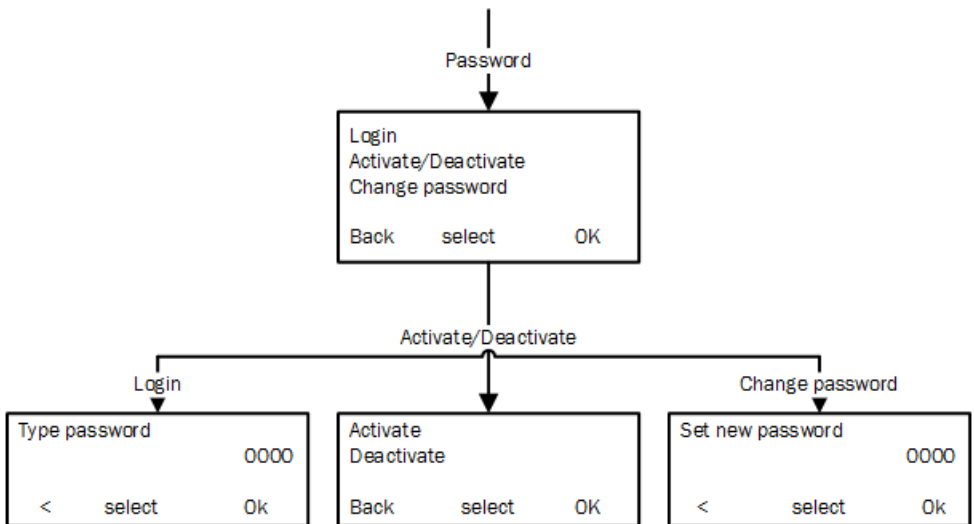

The available options are:

- **Login:** Select the digits one by one with the left/right keys and set the values with the up/down keys and press **OK**.
- **Activate/Deactivate:** Write protection. Selecting **Activate** means that a password must be entered to change vital settings. **Deactivate** disables password protection. If your current password is lost or forgotten, the password protection can be overruled with the code **01750**.
- **Set new password:** The selected 5-digit password can be changed as required.

Set sensor name

A unique name and/or number, a function or a location can be assigned as name for a sensor (here: **MagFlux1**). It is consequently shown on the main display with up to four display lines.



1. Press the up/down keys to highlight the required menu line (here: **Sensor Name**) and press **OK**.

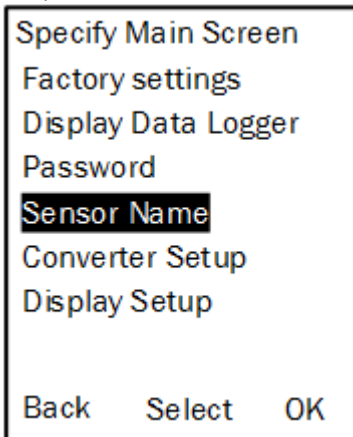

- To change the default sensor name (**MagFlux1**), press the left/right keys to highlight the wanted character.

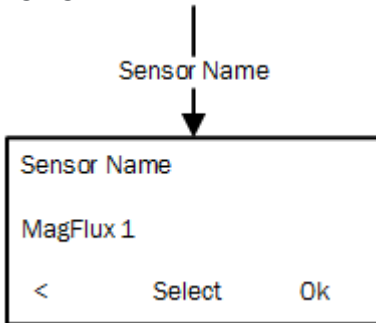

- Select the digits one by one with the left/right keys and set the value with the up/down keys.
- Continue until the name has been set to, for example, Inlet flow (see the following).
- Press **OK**.



The available characters depend on the chosen language. English, for example, provides the following character set:

**abcdefghijklmnopqrstuvwxyzABCDEFGHIJKLMNOPQRST
UVWXYZ <space> 1 2 3 4 5 6 7 8 9 and 0.**

Converter setup

Converter Setup provides configuration options for volumes, batches, units, etc. See detailed descriptions in the following sections and in the overview sections at the end.

1. Press the up/down keys to highlight the required menu line (here: **Converter Setup**) and press **OK**.

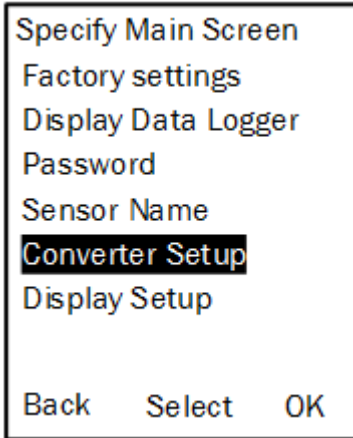

2. Press the up/down keys to highlight the required option and press **OK**.

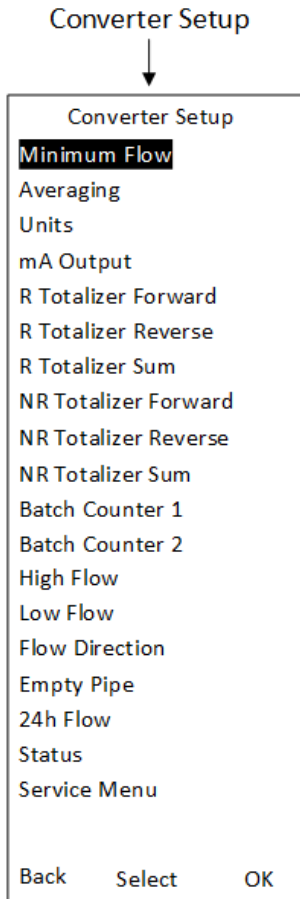

The available options are described in detail in the following sections.

Minimum flow

Sets the minimum forward and reverse flow rate. MagFlux® flow meters are default set to 0,1 m/s. For other values, see [Sizing Chart](#) (see page 20). The unit for the flow rate can be set from the **Units** option (see [Units](#) (see page 70)).

You can set both the forward and reverse minimum flow. By setting the minimum flow, you indicate when the MagFlux® flow meter should stop measuring.

The **1 m/s** indicates the flow volume at the selected unit.

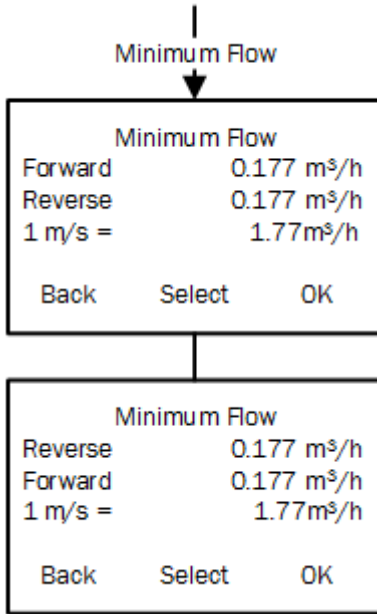

1. Select the digits one by one with the left/right keys and set the value with the up/down keys.
2. When you press **OK**, **Reverse** and **Forward** will change places and you can edit the other one.
3. Press **OK** to save.

Averaging

Standard averaging (the first setting) indicates the time period within which measurements are smoothed and averaged.

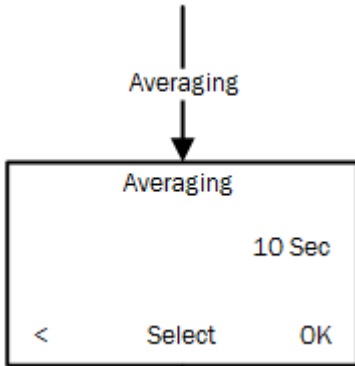

1. In **Averaging**, to change the standard averaging period, select the digits one by one with the left/right keys and set the value with the up/down keys.
2. Press **OK**.

Units

Sets the unit for the flow rate. The available units are shown below.

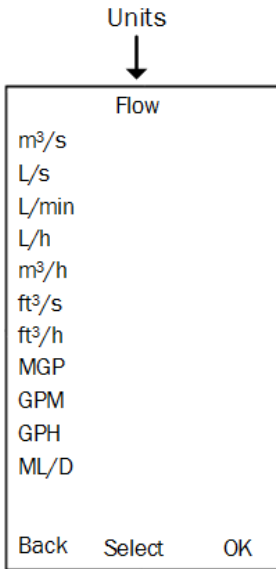

1. Press the up/down keys to highlight the required unit and press **OK**.

mA output

When a MagFlux® is connected to a power supply for the first time, the mA output is automatically set to provide 4 mA at zero flow and 20 mA at a flow corresponding to the theoretical Q_{max} of the flow sensor. Changes in the mA setting will not affect the relay output settings.

Note: Both values can be set in the range 10% to 120%, making it possible to increase or decrease the mA signal.

The **mA Output** parameters can be configured in four different ways. Each option is described in the following sections.

mA Output



Flow Forward
Flow Reverse
Forward & rev. (12mA=0)
Forward & rev. (4mA=0)
Not in use
Back Select OK

Using the factory setup, MagFlux® returns to default mA settings corresponding to the chosen MagFlux® flow sensors Q_{min} and Q_{max} . The mA output is an active output, and the maximum load is 600 Ohm. The upper limit for the mA output is 20,5 mA:

- 3,75 mA indicates the mA output is not in use
- 3,5 mA indicates flow under 4 mA level
- 20,5 mA indicates flow higher than 20 mA level.

The 20 mA maximum output is rounded up to the nearest round figure.

Example: The maximum flow of 17.676 m³/h for a DN25 is rounded up to 20.000 m³/h.

Flow forward

The mA signal provides 4 mA at zero flow and 20 mA at Q_{max} in the forward direction. The 1 m/s indicates the flow volume at the selected unit.

Flow Forward
↓

mA Output		
20 mA =	20.000	m ³ /h
1 m/s =	1.45	m ³ /h
<	Select	OK

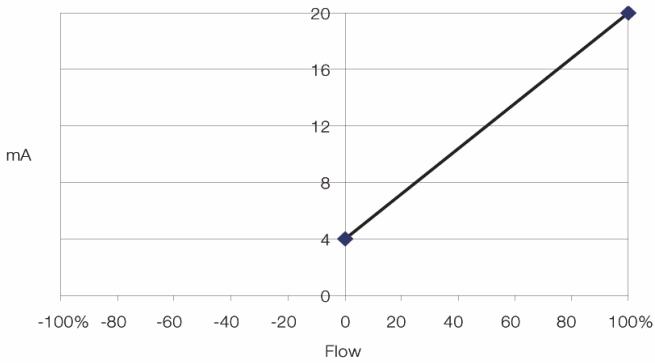

Flow reverse

The mA signal provides 4 mA at zero flow and 20 mA at Q_{max} in the reverse direction. The 1 m/s indicates the flow volume at the selected unit.

Flow Reverse
↓

mA Output	
20 mA =	20.000 m ³ /h
1 m/s =	1.45m ³ /h
<	Select OK

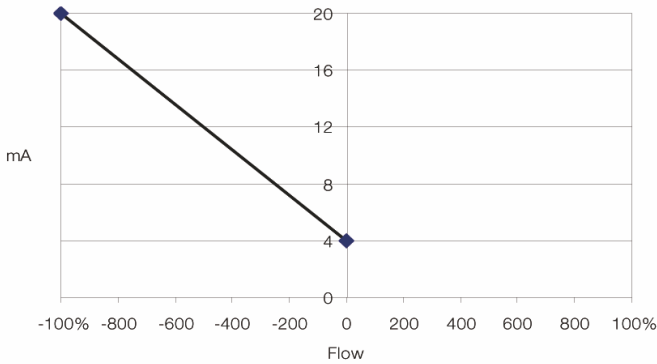

Forward & rev. (12mA=0)

The mA signal provides 4 to 20 mA reverse to forward direction with 12 mA at zero flow. The 1 m/s indicates the flow volume at the selected unit.

Forward & rev. (12mA=0)

mA Output

4mA=20mA= 20.000 m³/h

1 m/s = 1.45m³/h

< Select OK

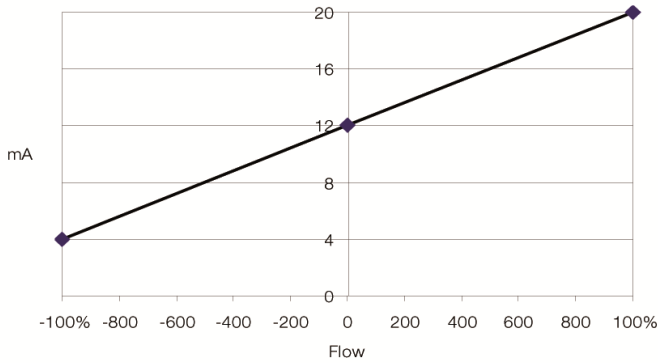

Forward & rev. (4mA=0)

The mA signal provides 4 to 20 mA for forward and reverse flow with 4 mA at zero flow. The 1 m/s indicates the flow volume at the selected unit.

Forward & rev. (4mA=0)



mA Output	
4mA =	0,00 m ³ /h
20mA =	20.000 m ³ /h
1 m/s =	1.45m ³ /h
<	Select OK

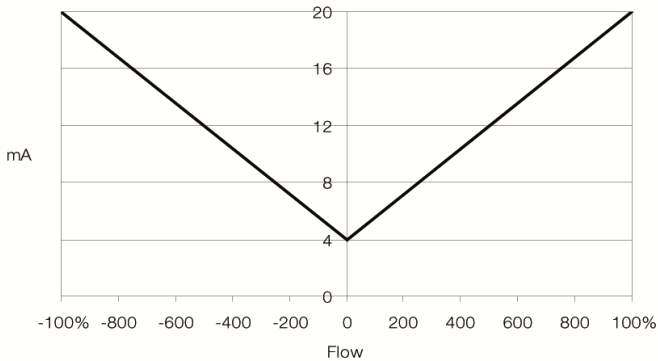

Not in use

The **mA Output** option is not being used.
The 1 m/s indicates the flow volume at the selected unit.

MJK totalizers

The MagFlux® provides six totalizers, each with two or three output options. Up to two totalizers can be assigned to one digital output.
The totalizers are:

- **Resettable Totalizer Forward**
- **Resettable Totalizer Reverse**
- **Resettable Totalizer Sum**

and

- **Non-Resettable Totalizer Forward**
- **Non-Resettable Totalizer Reverse**
- **Non-Resettable Totalizer Sum**

The available output options for the resettable totalizers are:

- **Mechanical Relay** (DO2)
- **Opto Relay** (DO1) (light-triggered electronic relay)
- **Display only** (on the display unit)

The available output option for the non-resettable totalizers is:

- **Display only** (on the display unit)

If a chosen output is not available (dedicated to another function), a Device Exception pop-up message will inform the operator.

Settings and limits for resettable totalizers

- **Totalizer Forward Unit:** Available units are l, hl, kl, m³, ft³, gal and MG.
- **Reset with Digital Input:** Reset the totalizer via the digital input (DI).
- **On-time:** The pulse length of the opto digital output (DO1) is adjustable from 1 ms to 10 secs. The pulse length of the mechanical digital relay (DO2) is adjustable from 100 ms to 10 secs.
- **Volume between Pulses:** Select a volume between pulses in steps of: 0,001, 0,01, 0,1, 1, 10, 100 and 1000.

MagFlux® Totalizer Output Setting					
Metric					
	Optical DO 1 @100 mSec.		Mechanical DO 2 @100 mSec.		
DN [mm]	min.	max.	min.	max.	Unit
15	0,001	1	0,1	1	m ³
20	0,001	1	0,1	1	m ³
25	0,01	10	1	10	m ³
32	0,01	10	1	10	m ³
40	0,01	10	1	10	m ³
50	0,01	10	1	10	m ³
65	0,01	100	1	100	m ³
80	0,1	100	10	100	m ³
100	0,1	100	10	100	m ³
125	0,1	100	10	100	m ³
150	0,1	100	10	100	m ³
200	0,1	1000	10	1000	m ³
250	1	1000	100	1000	m ³
300	1	1000	100	1000	m ³
350	1	1000	100	1000	m ³
400	1	1000	100	1000	m ³

MagFlux® Totalizer Output Setting					
Metric					
	Optical DO 1 @100 mSec.		Mechanical DO 2 @100 mSec.		
DN [mm]	min.	max.	min.	max.	Unit
450	1	1000	100	1000	m ³
500	1	1000	100	1000	m ³
600	1	10000	100	10000	m ³
700	1	10000	1000	10000	m ³
800	10	10000	1000	10000	m ³
900	10	10000	1000	10000	m ³
1000	10	10000	1000	10000	m ³
1200	10	10000	1000	10000	m ³

If a required volume between pulses is not contained in the above steps, for example, for a preset to a sampler, use the batch counter option. The relays are limited to a minimum and a maximum of pulses per hour depending on the 20 mA scale and the on-time of the relay in milliseconds.

DO 1 (Opto Relay): The maximum limit is 500 pulses per sec at 1 ms pulse length.

The formula for the minimum flow unit per pulses is: **(flow at 20mA) x (pulse delay in mSec) / 1800000**

Example: Min. flow unit/pulses for DN 100 max. flow 300 m³/h ?

Minimum flow unit per pulses = $300 \text{ m}^3 \times 100 \text{ mSec} / 1800000 = 0,016 \text{ m}^3$ which is rounded to $0,1 \text{ m}^3$ by the MagFlux®

The formula for the maximum flow unit per pulses is: **(flow at 20mA)**

Example: DN 100 max. flow 300 m³/h ?

Maximum flow unit per pulses = 300 m^3

DO 2 (Mechanical Relay): The maximum limit is 120 pulses per hour.

The formula for minimum flow unit per pulses is: **(flow at 20mA) / 120**

Example: DN 100 max. flow 300 m³/h ?

Minimum flow unit per pulses = $300 / 120 = 2,5 \text{ m}^3$ which is rounded to 10 m^3 by MagFlux®

The formula for maximum flow unit per pulses is: **(flow at 20mA)**

Example: DN 100 max. flow 300 m³/h ?

Maximum flow unit per pulses = 300 m^3

Resettable totalizers

Totalizers can be reset from the [main menu](#) (see page 53) and via the [digital input](#) (see page 37) DI.

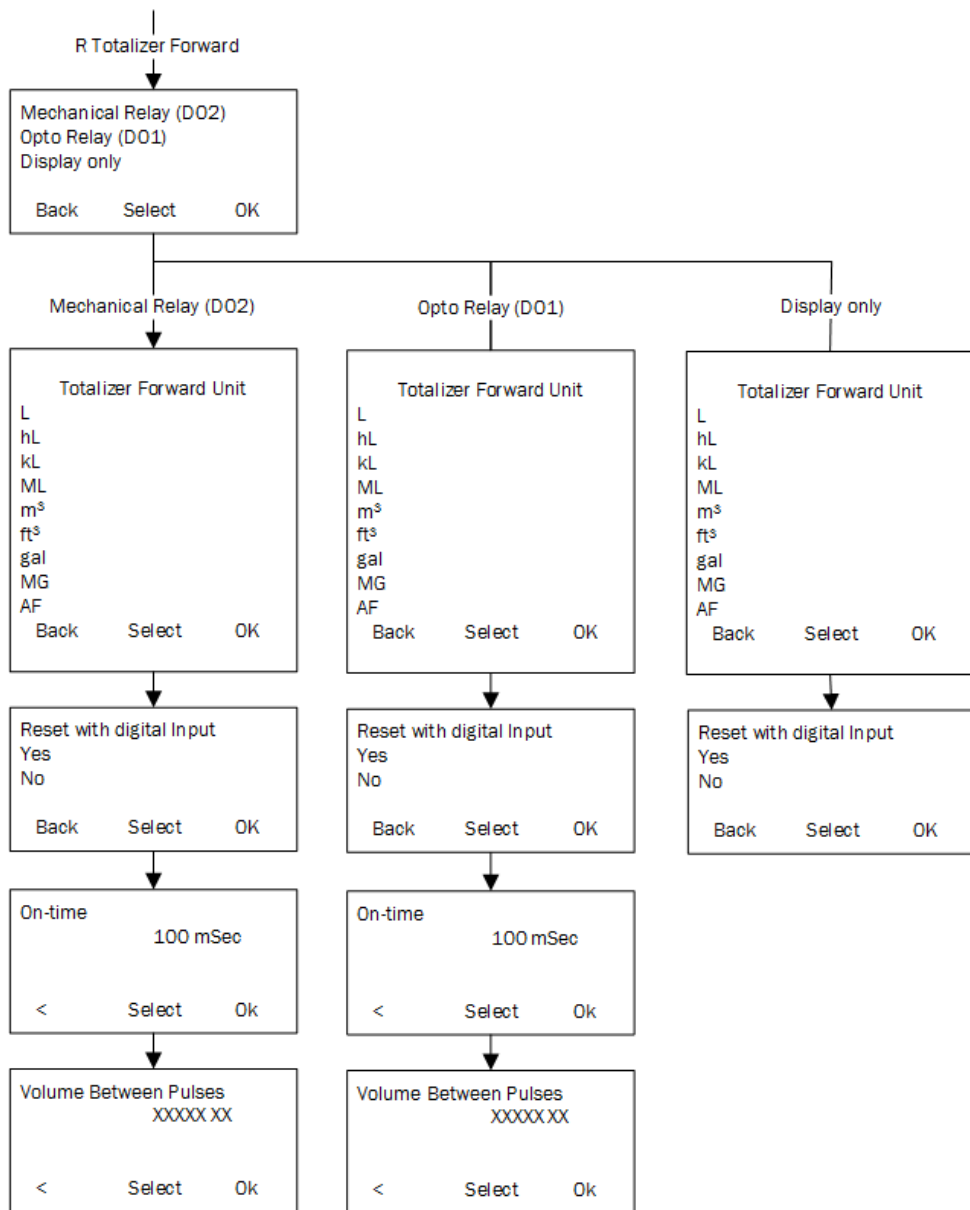

Resettable forward totalizer

RFTot: The Totalizer counts the forward flow volume according to the primary flow direction selected at startup. The Totalizer counts in selected units and is resettable. The counter can be connected to the relays or to the display only. To reset the counter, the totalizer must be present in the main display and be selected by the up/down keys followed by a click on **Reset**. Alternatively, it can be reset via the [digital input](#) (see page 37) DI.

Resettable reverse totalizer

RRTot: The Totalizer counts the reverse flow volume according to the primary flow direction selected at startup. The Totalizer counts in selected units and is resettable. The counter can be connected to the relays or to the display only. To reset the counter, the totalizer must be present in the main display and be selected by the up/down keys followed by a click on **Reset**. Alternatively it can be reset via the [digital input](#) (see page 37) DI.

Resettable Sum Totalizer

RSTot: The Totalizer counts the sum of forward flow volume minus the reverse flow volume according to the primary flow direction selected at startup. The Totalizer counts in selected units and is resettable. The counter can be connected to the relays or to the display only. To reset the counter, the totalizer must be present in the Main display and be selected by the up/down keys followed by a click on **Reset**. Alternatively it can be reset via the [digital input](#) (see page 37) DI.

Non-resettable totalizers

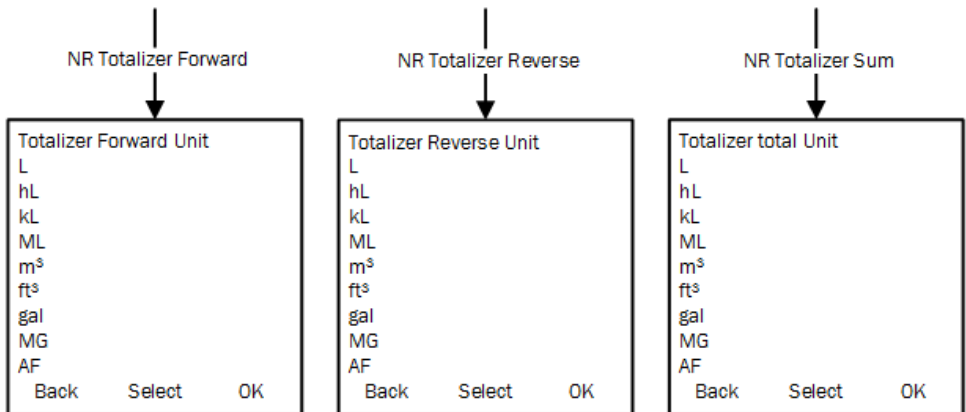

NR totalizer forward

NR FTot: The Totalizer counts the forward flow volume according to the primary flow direction selected at start up. The Totalizer counts in selected units and cannot be reset. The counter can only be selected from the **Main** display.

NR totalizer reverse

NR RTot: The Totalizer counts the reverse flow volume according to the primary flow direction selected at start up. The Totalizer counts in selected units and cannot be reset. The counter can only be selected from the **Main** display.

NR totalizer sum

NR Cnt: The Totalizer counts the sum of forward flow volume minus the reverse flow volume according to the primary flow direction selected at startup. The Totalizer counts in selected units and cannot be reset. The counter can only be selected from the **Main** display.

MJK batch counters 1 & 2

The batch counters can operate in three different ways: automatically, manually or adaptively, and they deduct a reverse flow from the forward flow.

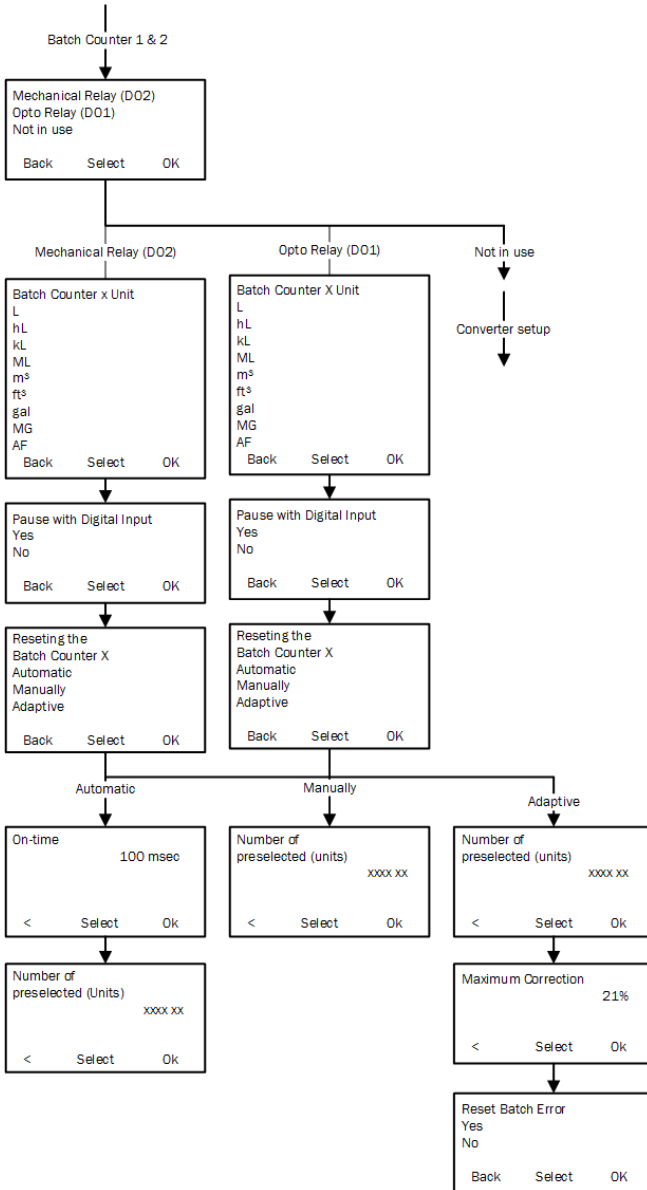

In the following descriptions of the batch counters, the function or digital status is illustrated as follows:

- Function or DO activated
- Function or DO deactivated

Automatic Batch Counter: The automatic batch counter issues a signal, when a preset volume is reached.

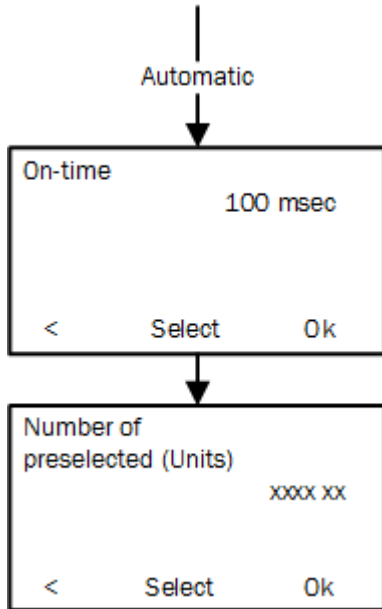

On-time: The period of time in which the relay is activated (drawn).

Number of preselected (units): The preset batch volume.

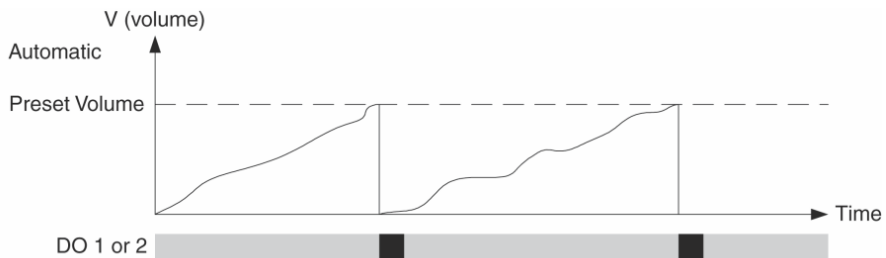

Manual Batch Counter: The counter issues signals as determined by manual start, stop and pause commands. A manual stop is equivalent to a reset command.

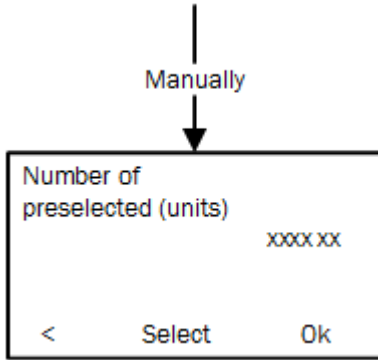

Number of preselected (units): The preset batch volume.

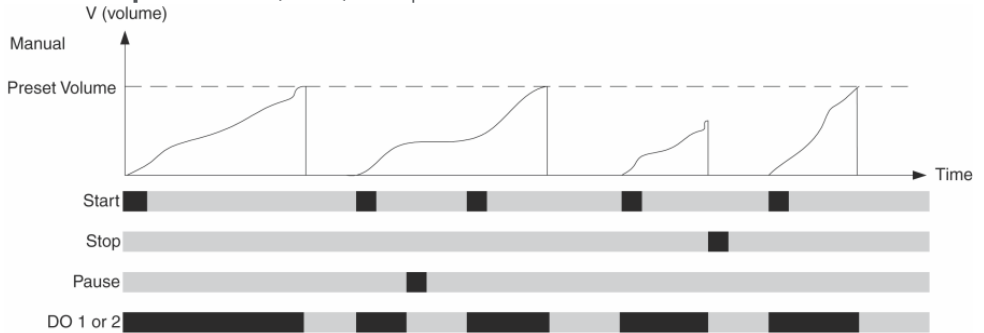

Adaptive Batch Counter: The counter compensates for overrun and insufficient flow.

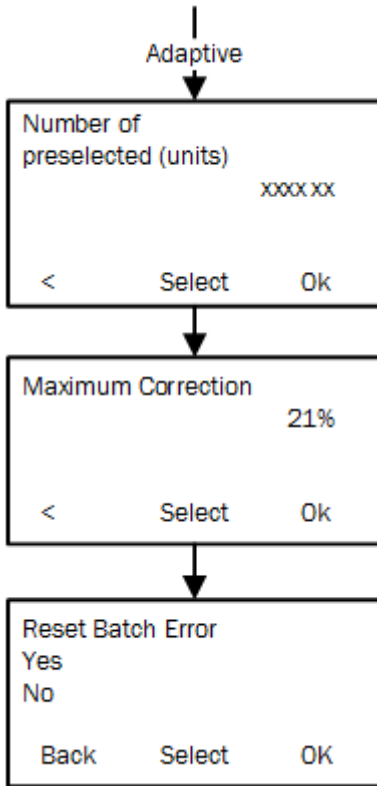

Number of preselected (units): The preset batch volume.

Maximum Correction: The correction in percent that triggers an error message or an alarm.

Reset Batch Error: Reset the batch correction percentage to 0%.

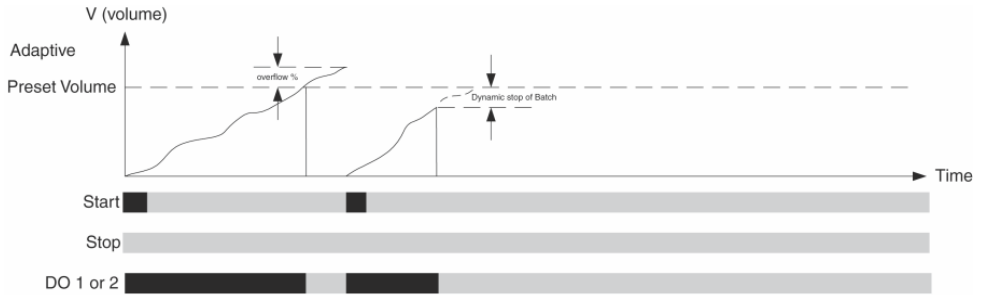

Settings and limits for batch counters

- **Batch counter units:** Available units are **l, hl, kl, m³, ft³, gal and MG.**
- **Start, stop or pause with Digital Input:** The manual and the adaptive batch counters can be started, stopped or paused via the digital input (DI)
- **On-time:** The pulse length of the opto digital output (DO1) is adjustable from 1 ms to 10 secs. The pulse length of the mechanical digital relay (DO2) is adjustable from 100 ms to 10 secs.
- **Volume between pulses:** Select a volume between pulses as listed in the table overleaf. The relays are limited to a minimum and a maximum of pulses pr. hour depending on the 20 mA scale and the on-time of the relay in milliseconds.

MagFlux® Batch Counter Output Settings - Metric							
Optical DO1 @100 mSec.				Mechanical DO2 @100 mSec.			
DN [mm]	min.		max.	min.		max.	Unit
	Auto- matic	Manually/ adaptive		Auto- matic	Manually/ adaptive		
15	0,0002778	0,0138889	5	0,041666 7	0,0138889	5	m ³
20	0,0005556	0,0277778	10	0,083333 3	0,0277778	10	m ³
25	0,0011111	0,0555556	20	0,166667	0,0555556	20	m ³
32	0,001667	0,0833333	30	0,250000	0,0833333	30	m ³
40	0,002778	0,138889	50	0,416667	0,138889	50	m ³
50	0,004167	0,208333	75	0,625000	0,208333	75	m ³
65	0,005556	0,277778	100	0,833333	0,277778	100	m ³
80	0,0111111	0,555556	200	1,666667	0,555556	200	m ³
100	0,016667	0,833333	300	2,500000	0,833333	300	m ³
125	0,0222222	1,1111111	400	3,333333	1,1111111	400	m ³
150	0,0333333	1,666667	600	5,000000	1,666667	600	m ³
200	0,0555556	2,777778	1000	8,333333	2,777778	1000	m ³
250	0,1111111	5,555556	2000	16,66667	5,555556	2000	m ³
300	0,138889	6,944444	2500	20,83333	6,944444	2500	m ³
350	0,166667	8,333333	3000	25,00000	8,333333	3000	m ³
400	0,250000	12,500000	4500	37,50000	12,500000	4500	m ³

MagFlux® Batch Counter Output Settings - Metric							
Optical DO1 @100 mSec.				Mechanical DO2 @100 mSec.			
DN [mm]	min.		max.	min.		max.	Unit
	Auto-matic	Manually/ adaptive		Auto-matic	Manually/ adaptive		
450	0,333333	16,666667	6000	50,00000	16,666667	6000	m ³
500	0,388889	19,444444	7000	58,33333	19,444444	7000	m ³
600	0,555556	27,777778	10000	83,33333	27,777778	10000	m ³
700	0,833333	41,666667	15000	125,0000	41,666667	15000	m ³
800	1,111111	55,555556	20000	166,6667	55,555556	20000	m ³
900	1,388889	69,444444	25000	208,3333	69,444444	25000	m ³
1000	1,666667	83,333333	30000	250,0000	83,333333	30000	m ³
1200	2,222222	111,111111	40000	333,3333	111,111111	40000	m ³

Limitation of the automatic batch counter on DO1 (Opto Relay): The maximum limit is 500 pulses per sec at 1 ms pulse length.

The formula for the minimum flow unit per pulses is: **(flow at 20mA) x (pulse delay in mSec) / 1800000**

Example: Min. flow unit/pulses for DN 100 max. flow 300 m³/h ?

Minimum flow unit per pulses = $300 \text{ m}^3 \times 100 \text{ mSec} / 1800000 = 0,016 \text{ m}^3$ which is rounded to 0,1 m³ by MagFlux®.

The formula for the maximum flow unit per pulses is: **(flow at 20mA)**

Example: DN 100 max. flow 300 m³/h ?

Maximum flow unit per pulses = 300 m^3

Limitation of the automatic batch counter on DO2 (mech. relay): The maximum limit is 120 pulses per hour.

The formula for minimum flow unit per pulses is: **(flow at 20mA) / 120**

Example: DN 100 max. flow 300 m³/h ?

Minimum flow unit per pulses = 300 / 120 = 2,5 m³

The formula for maximum flow unit per pulses is: **(flow at 20mA)**

Example: DN 100 max. flow 300 m³/h ?

Maximum flow unit per pulses = 300 m³

Limitation of the manual and adaptive batch counter on DO1 or DO2:

The formula for minimum flow unit per pulses is: **(flow at 20mA) / 360**

Example: DN 100 max. flow 300 m³/h ?

Minimum flow unit per pulses = 300 / 360 = 0,833 m³

The formula for maximum flow unit per pulses is: **(flow at 20mA)**

Example: DN 100 max. flow 300 m³/h ?

Maximum flow unit per pulses = 300 m³

High flow/low flow

Provides alarms and triggers relays when certain volume limits are exceeded or not reached.

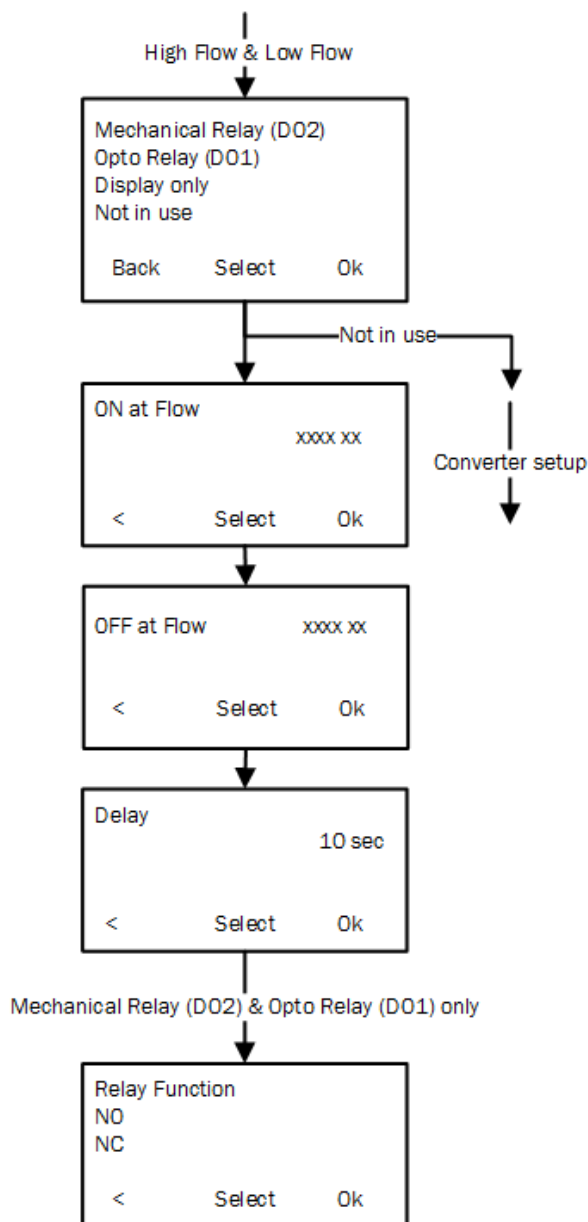

The available output options for **High Flow** and **Low Flow** are:

- **Mechanical Relay (DO2)**
- **Opto Relay (DO1)** (light-triggered, electronic relay)
- **Display only** (signals to the **display unit** only)
- **Not in use** (the **High/Low Flow** option is not being used)

ON at Flow: Issues an alarm and/or sends a signal when, for example, a high flow limit is exceeded.

OFF at Flow: Cancels an alarm and/or sends a signal when recovering from, for example, an overflow situation.

Delay: A delay in seconds can be set to compensate for positive and negative spikes in the flow. The length is the time between an incident and setting an alarm.

Relay Function:

- **NO** (Normally Open) determines the relay state under normal conditions.
- **NC** (Normally Closed) determines the relay state under normal conditions.

Flow direction

Indicates the direction of the flow and determines the open/closed state of the relay. The default **Flow Direction** is set to **Direction A**.

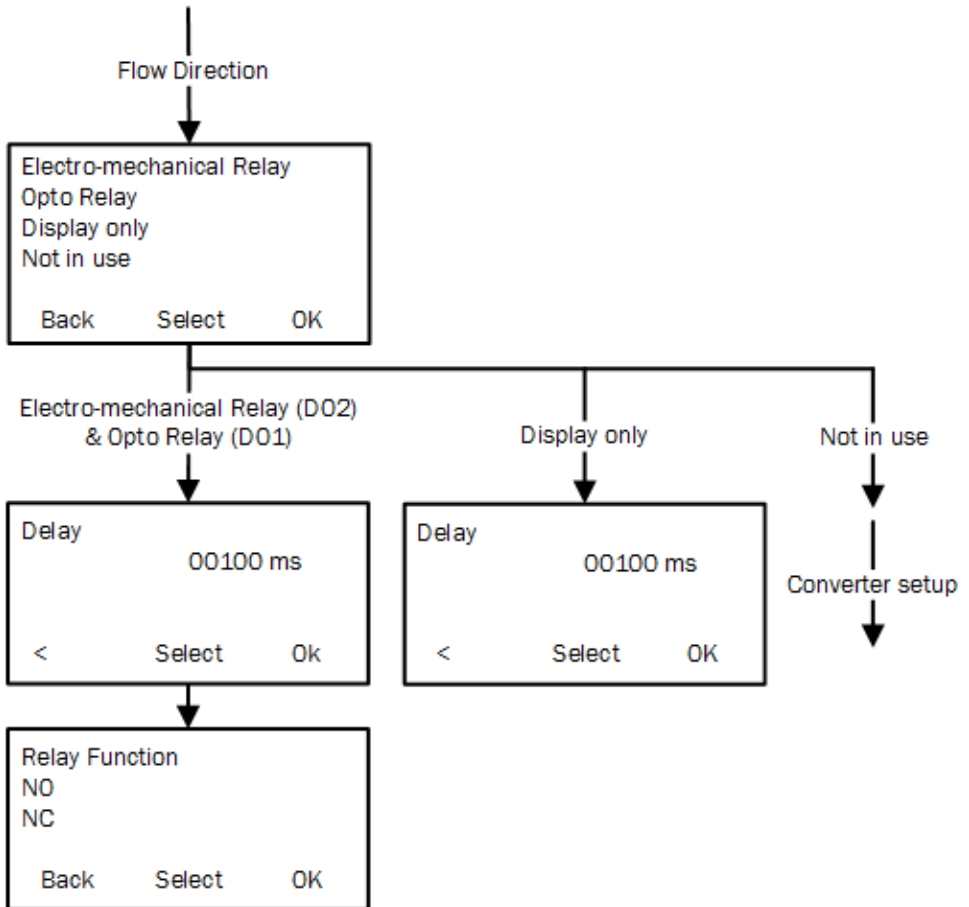

The available output options for **Flow Direction** are:

- **Mechanical Relay (DO2)**
- **Opto Relay (DO1)** (light-triggered electronic relay)
- **Display only** (signals to the display unit only)
- **Not in use** (the Flow Direction option is not being used)

Delay: A delay in seconds can be set to compensate for positive and negative spikes in the flow. The length is the time between an incident and setting an alarm.

Relay Function:

- **NO** (Normally Open) determines the relay state under normal conditions.
- **NC** (Normally Closed) determines the relay state under normal conditions.

Empty pipe

A signal and/or an alarm can be set, when the sensor becomes practically empty (see also [Pipe system](#) (see page 23)), or if the conductivity drops below 5 µS/cm.

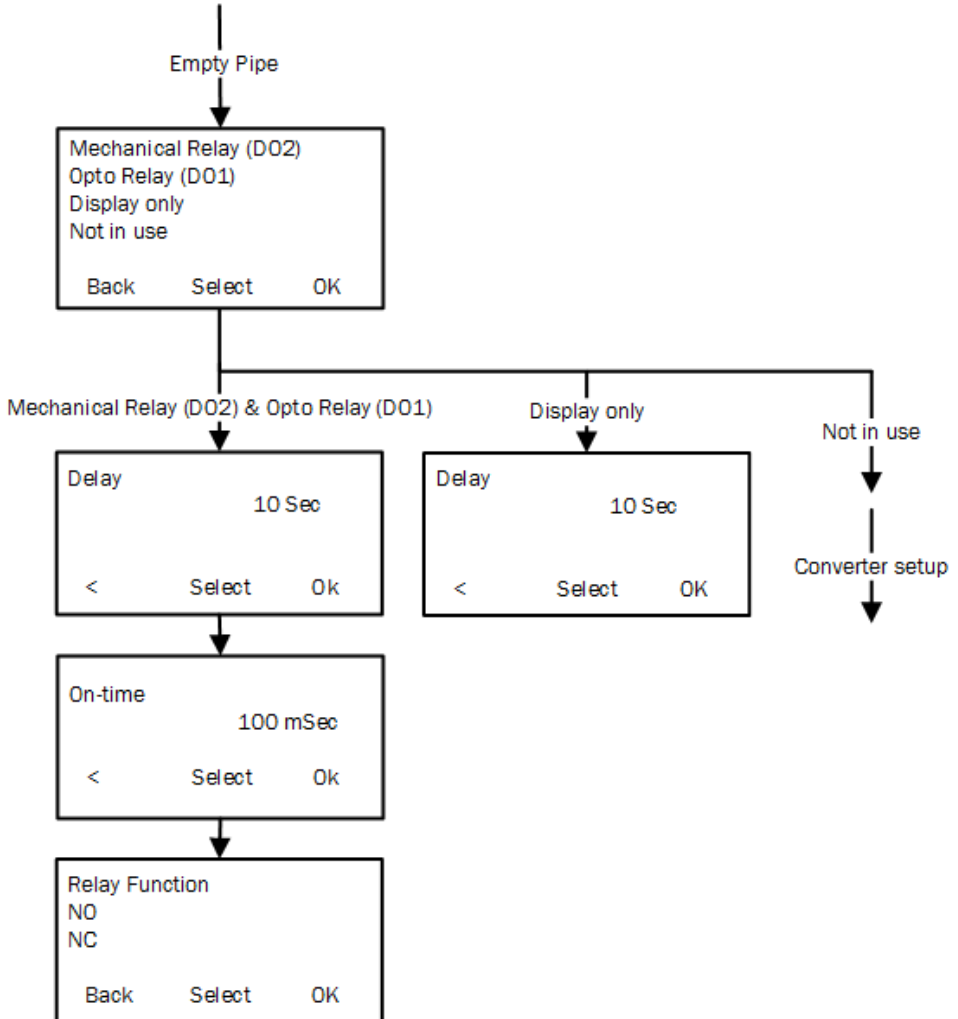

The available output options for **Empty Pipe** are:

- **Mechanical Relay (DO2)**
- **Opto Relay (DO1)** (light-triggered electronic relay)
- **Display only** (signals to the display unit only)

- **Not in use** (the Empty Pipe option is not being used)

Delay: A delay in seconds can be set to compensate for positive and negative spikes in the flow. The length is the time between an incident and setting an alarm.

On-time: The period of time in which the relay is activated (in on-state).

Relay Function:

- **NO** (Normally Open) determines the relay state under normal conditions.
- **NC** (Normally Closed) determines the relay state under normal conditions.

24h flow

Measures the total flow (FTot) for 1 day (24 hours) and logs at midnight (12 PM).

NB! It takes up to 48 hours from power on before a valid value can be viewed from the log.

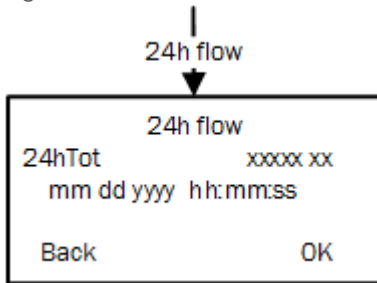

Status

The **Status** option provides an overview of the in- and output status. The check-boxes can contain four different characters to indicate the current status at that very moment:

- **X**: A cross (X) in a check box indicates an active state
- **/**: A blinking forward slant (/) indicates that the input/output is in the process of being activated. Eventually, it turns into a steady X.
- ****: A blinking backward slant (\) indicates that the input/output is in the process of being deactivated. Eventually, the check box is cleared
- An empty check box indicates a deactivated state.

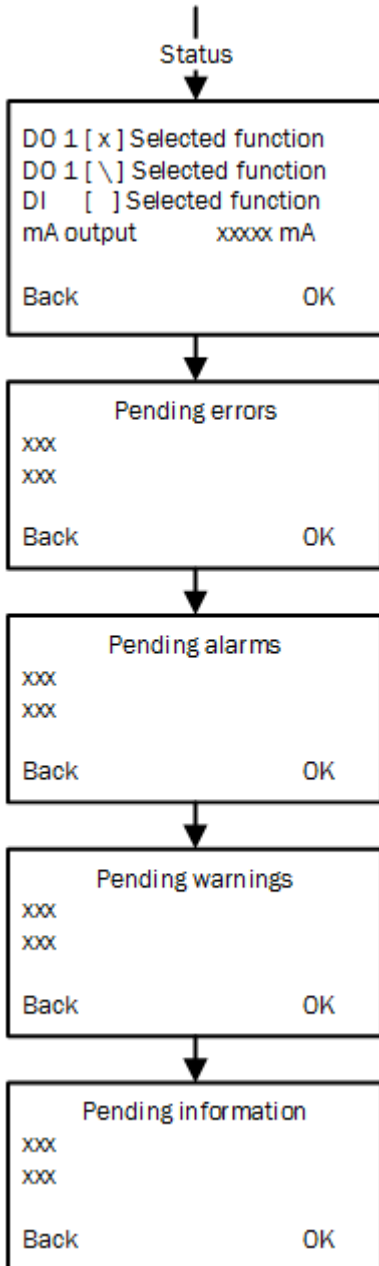

The available output options for Status are:

- **DO1:** Status for Digital Output 1.
- **DO2:** Status for Digital Output 2.
- **DI:** Status for Digital Input.
- **mA output:** The present analog output current in mA.

Pending errors: Lists pending errors.

Pending alarms: Lists pending alarms.

Pending warnings: Lists pending warnings.

Pending information: Lists pending information.

Service menu

The **Service Menu** provides options intended for service personnel during installation, calibration, operation, monitoring and maintenance. All parameters can be read without any restrictions, but certain parameters can only be changed after a password has been typed.

Sensor calibration code

Each and every MagFlux® has a unique calibration code that contains calibration data for the specific unit. A calibration code could for example be **dw5uq4** or **7v3ri0**. The current MagFlux® converter firmware requires an 8-character input, but it also accepts 6 characters plus two **OK**'s. If the code is **dw5uq4**, enter:

d w 5 u q 4 OK OK

where **OK** indicates that you press the **OK** key without selecting any character. Only lower case letters can be entered from the MagFlux® keypad.

Important: All letters are lower case letters (e.g. a and not A), and numbers are numbers (e.g. **0**, zero and not lower case **o**). A potential source of error is incorrect reading of numbers and letters, where a lower case o is confused with a zero (**0**), or a lower case l is confused with the number one (**1**).

NB! This menu items is usually only used once, when first employing the MagFlux®. However, it can be used later to change the flow direction if needed.

- **Set Flow Direction:** Used to indicate the direction of the flow in the pipe to which the MagFlux® is mounted. The default flow direction is **A**. See the section on product identification regarding the calibration code and where to find it. A password is not required to add or change the sensor calibration code.

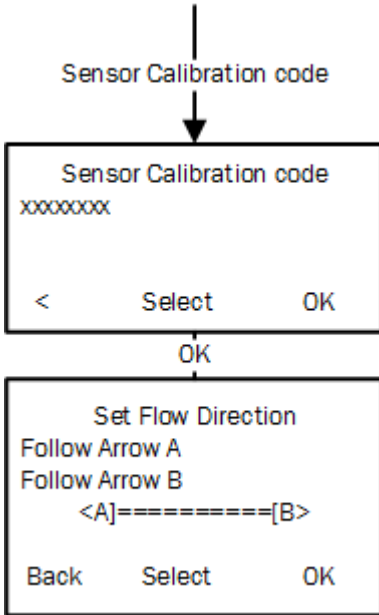

Converter software ver.

The converter software version and bootload version are displayed, so that you can determine whether a software (firmware) upgrade is required or not.

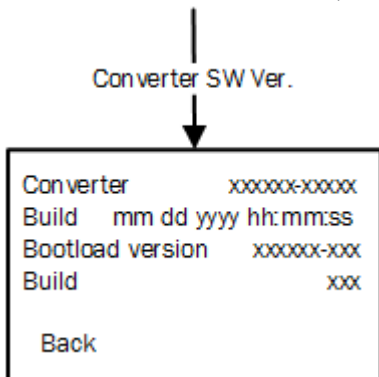

Product info

Key product data like serial number, hardware type no., track no., etc. are displayed.

Product Info

Serial Number	xxxxxxx
Product type No	xxxxxx
Track no	x
HW type No	xxxxxxxx
Back	OK

Reset counter time

The counter reset and run-time can be reset for fault finding, error correction and similar service procedures.

Reset Counter Time

Startup count	xx
System Runtime	xxxxxxx
Since reset	xxxxxx
Runtime (days)	xx
Back	OK

Internal meas. & cal.

For our service technician's use only. Internal measurements and calculations used for adjustments and calibrations.

Internal Meas. & Cal.

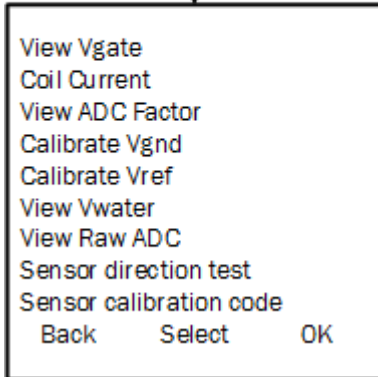

Minimum velocity

Sets the minimum forward and reverse flow velocity. MagFlux® flow meters are default set to 0,1 m/s. For other values, see [Sizing Chart](#) (see page 20). You can set both the forward and reverse minimum flow. By setting the minimum flow, you indicate when the MagFlux® flow meter should stop measuring.

The value under the selected item indicates the flow volume at the selected unit.

1. Select the digits one by one with the left/right keys and set the value with the up/down keys.
2. When you press **OK**, **Reverse** and **Forward** will change places and you can edit the other one.
3. Press **OK** to save.

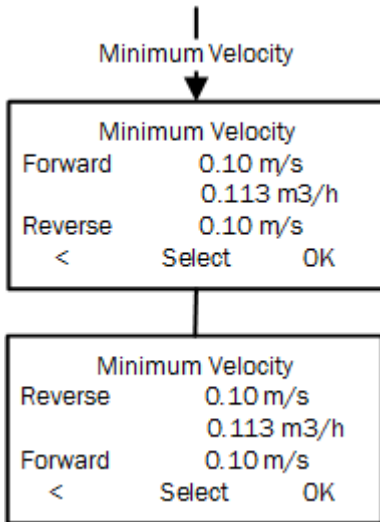

Calibrate mA

From this menu, the mA reading can be read, set and calibrated against a multimeter.

- **Current:** Indicates the actual current output.
- **Set fixed current:** Lets you set the mA to a fixed output of either 4, 12 or 20 mA or to a minimum mA or a maximum mA, primarily used for test purposes.
- **Calib. current:** Lets you calibrate the mA output. **NB!** This should be done by trained personnel only and a password login is required.
- **DAC zero current:** Indicates raw current values for internal usage only.
- **DAC top current:** Indicates raw current values for internal usage only.

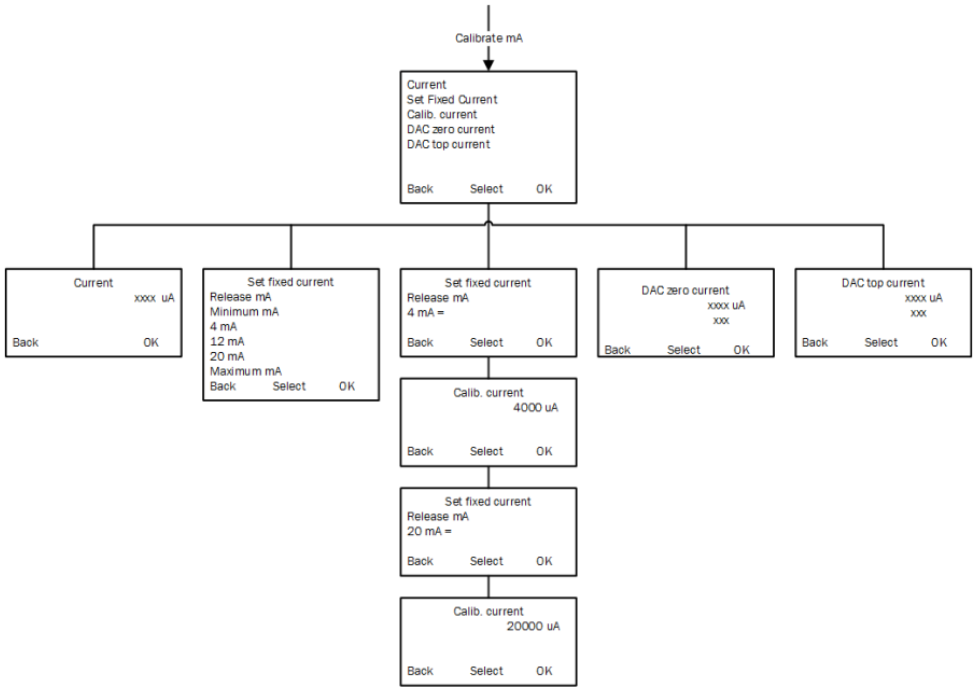

Test velocity

For our service technician's use only. Can be used to compare the actual velocity against the flow/velocity/diameter chart.

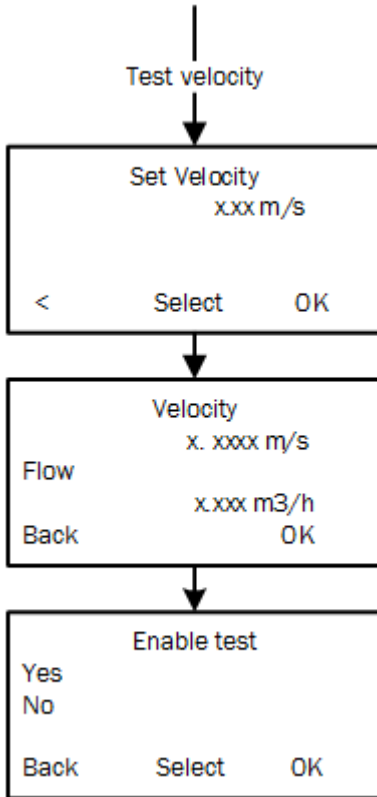

Freeze coil

For our service technician's use only. The sensor coil current and voltage values can be "frozen" to enable read-out using a standard multimeter.

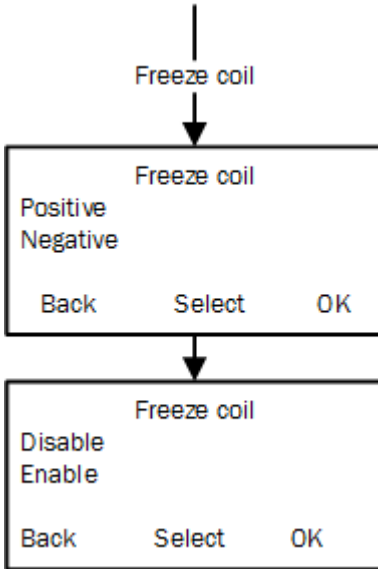

Read eventlog

See the events within a certain time frame.

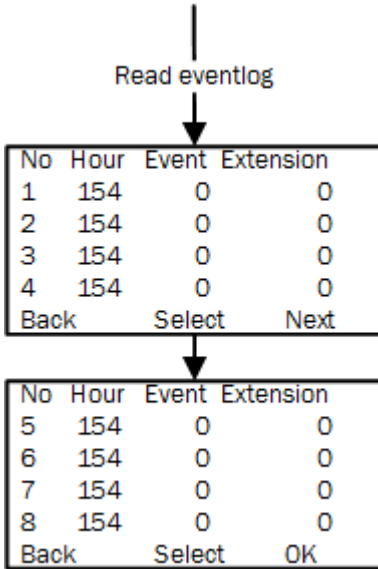

Back on stock

Resets the factory settings. This should be done by trained personnel only and a password login is required.

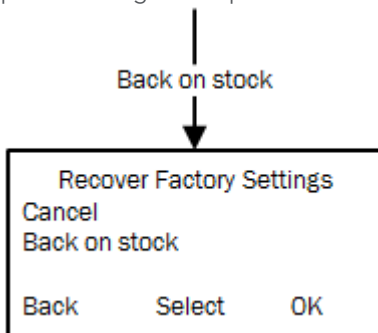

Popup on/off

Lets you determine which pop-up alarms you wish to see in your MagFlux® display. Click **Change** to disable a popup when it is selected.

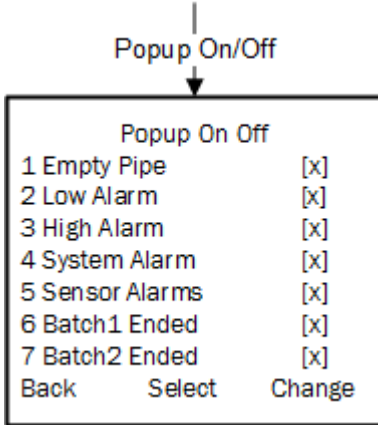

! The following item is for future usage only!

Zero point calibration

If, for some reason, your MagFlux® detects a minimal flow, but you know that there is no actual flow, you can use this feature to - within certain limits - adjust the zero point. You can do this either automatically or manually. From here, it is also possible to restore to the factory zero point:

- **Auto Zero:** Lets you auto calibrate the zero point by pressing **Start**.
- **Manual Calibration:** Lets you manually calibrate the zero point by entering a calibration value next to **User**.
- **Restore factory calibration:** Lets you restore the zero point by pressing **Yes**.

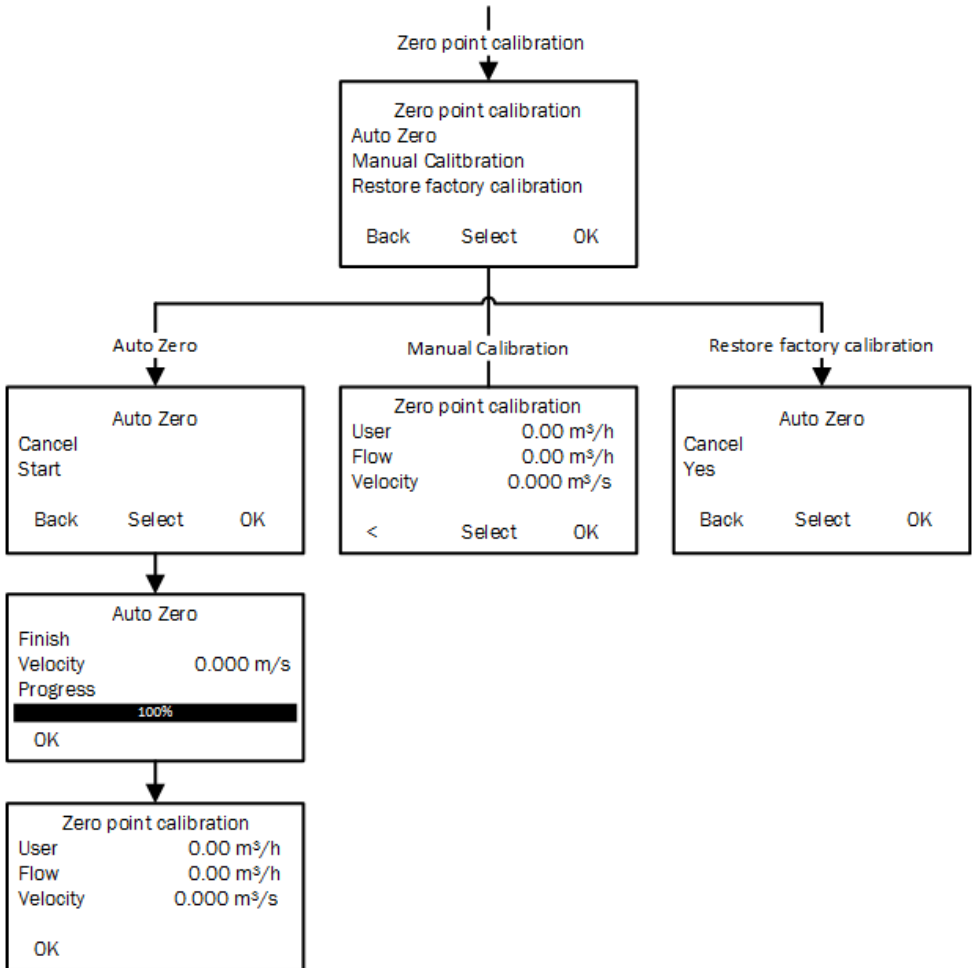

! The following item is for future usage only!

Verification

This part of the menu requires special training and special equipment. Contact your us for assistance.

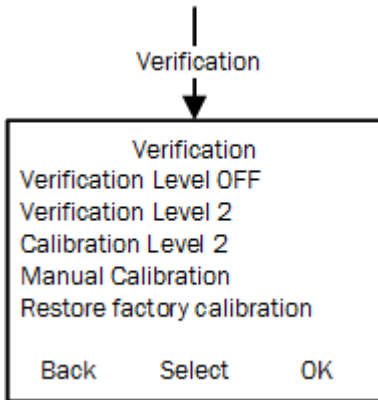

Display setup

The **Display Setup** menu provides configuration options for language, clock and factory settings and Modbus parameters and software version display.

1. Press the up/down keys to highlight the required menu line (here: **Display Setup**) and press **OK**.

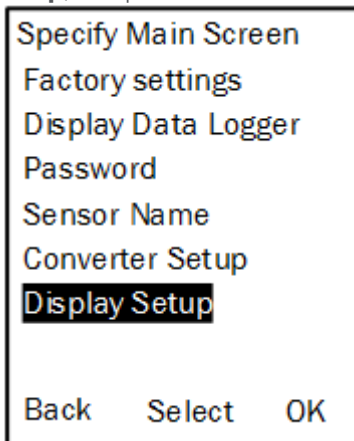

2. Press the up/down keys to highlight the required option and press **OK**.

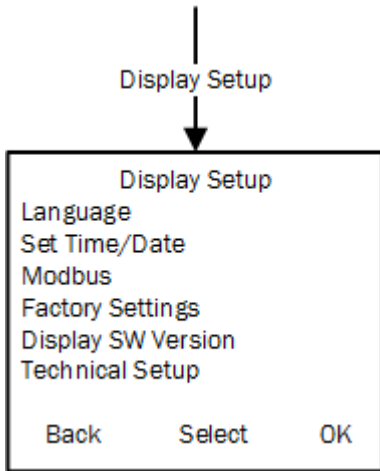

The available options are described in detail on the following sections.

Note: The option **Modbus Com Module** is only visible (and selectable), if a communication module is installed and connected to the MagFlux® display. If the communication module is removed, the option disappears automatically.

MJK communication modules documentation

A description of available communication settings can be found in the manual for communication modules **Modbus Communication Module**¹.

Language

The MagFlux® is installed with a language package, and GB English is the default language. In the **Language** menu, several languages can be selected (below languages

¹ <https://mjk.com/media/2200/en-681-modbus-communication-module-205546-manual-1212.pdf>

are examples).



Chose the required language using the up/down keys up and press **OK**.

Additional languages can be added using the **Field Link** software, see **Appendix B**.

Set clock

The **Set Time/Date** menu provides setting of the built-in clock and time format.

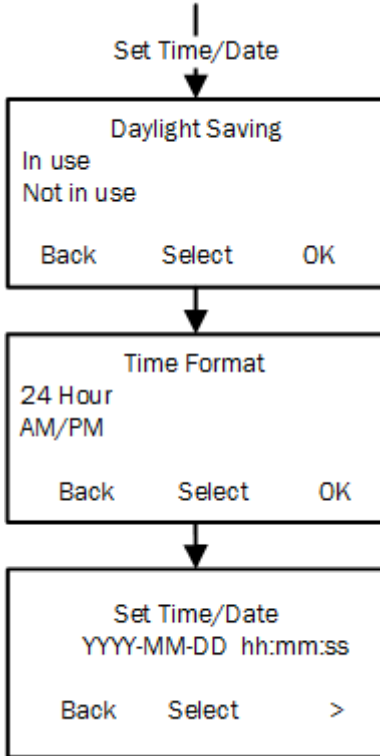

1. Select whether daylight saving is in use or not.
2. Select the time format.
3. Select the date and time digits with the left/right keys and change the setting with the up/down keys.
4. Press **OK** and repeat for all remaining digits.
5. Press **OK** to save the time/clock settings.

Modbus

The MagFlux® is delivered with a standard Modbus RTU protocol, and up to four MagFlux® converters can be connected for concurrent operation.

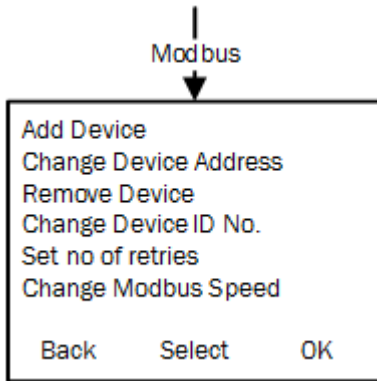

When several converters are to be added, it is necessary to change each converter device address to a unique ID address. This can be done from the display before doing the Modbus connection.

Add Device

Four MagFlux® converters can be connected to one MagFlux® display unit using the RS485 interface connection.

Note! Only one display unit can be used with several converters.

The MagFlux® display unit can easily be moved to other converters for readout and configuration.

1. Select **Add Device**, and wait for the scan process to finish.
2. The found converters are displayed. Click **OK** to return to the menu.

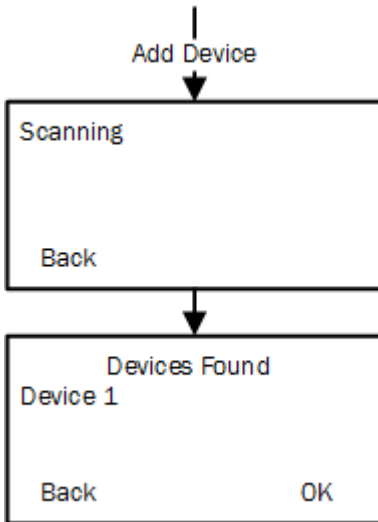

Change Device Address

To change each converter's device address, it is required that you connect the MagFlux® display unit to each converter one by one. If neglected, a conflict between the units will arise when the RS 485 serial loop is established.

Change for example **Device 1** to **Device 2** as follows:

1. Press **OK** and use the up/down keys to change **1** to **2**.
2. Press **OK**.

The MagFlux® converter ID is now changed to **2**, and more converters can be added to the display unit with the **Add Device** option.

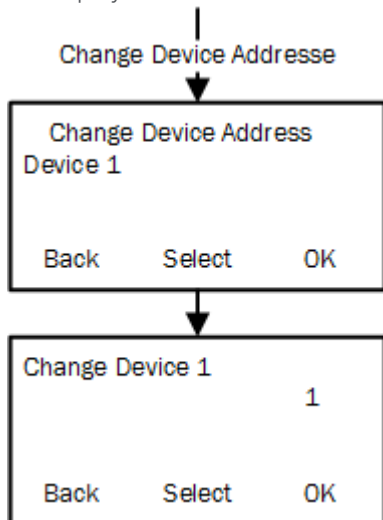

Remove Device

If a device is to be removed from the display unit, proceed as follows:

1. Select the required device with the up/down keys.
2. Click **OK** to remove it.

The device is now removed from the display unit and the display returns to the Modbus menu.

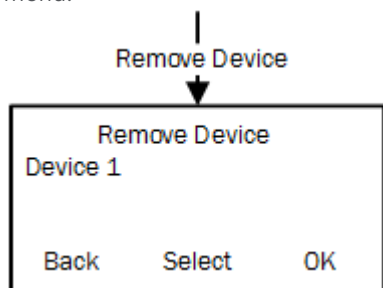

Change Display ID No.

The display ID number and the number of displays may have to be changed to avoid conflicts on the Modbus.

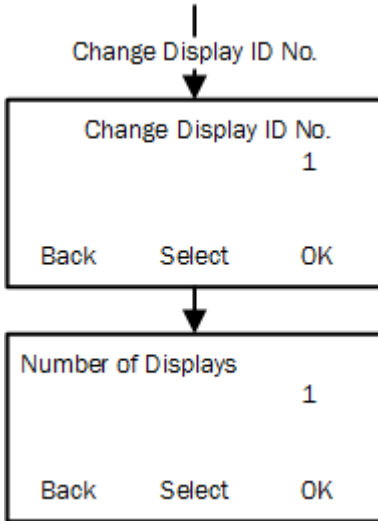

Set No. of Retries

If the data communication lines are subject to noise or other disturbances, the number of retries can be raised to increase the chances of a successful change of settings.

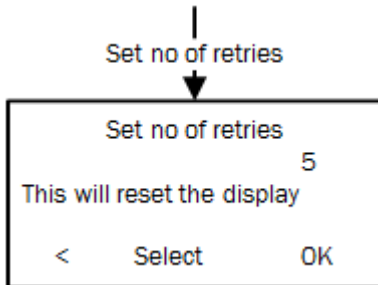

Change Modbus speed

Change between high and low Modbus speed. Default is low.

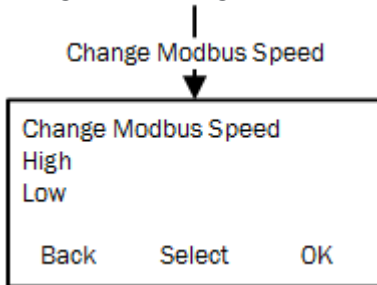

Factory setting setup

The **Factory Settings** menu provides log deletion and resetting the display unit to factory settings.

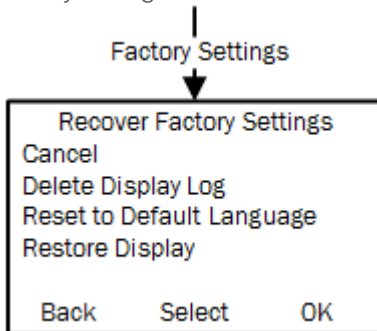

1. Press the up/down keys to highlight the required option and press **OK**.

Important: The Data Logger will be reset, and all devices will be deleted from the display Unit. This is indicated by the start-up screen which is displayed within a few seconds.

- **Cancel:** Returns to the Display Setup menu.
- **Delete Display Log:** Deletes the flow log.
- **Reset to Default Language:** Restores the display language to the default language.
- **Restore Display:** Restores the display to the default settings.

Display SW version

The **Display SW Version** menu provides a read-out of the display software (actually firmware) version, the build date and last-edited date of the the multiple languages file.

Display SW Version



Display	841xxx-xxx
Build Mmm dd Yyyy hh:mm:ss	
Language	841xxx-xxx
Back	

Mechanical dimensions

MJK standard flanges - EN-1092-1_2001 - Europe

Flange marking: **zzz/EN 1092-1/01 A/DN xxxx/PN ww/S235JR/yyyy**
where:

zzz = Manufacturer's name/
trademark
EN 1092-1 = Standard number
01 A = Flange type
DN xxxx = DN (size)
PN ww = PN (pressure)
S235JR = Material symbol/no/grade
yyyyy = Traceable ID or control no.

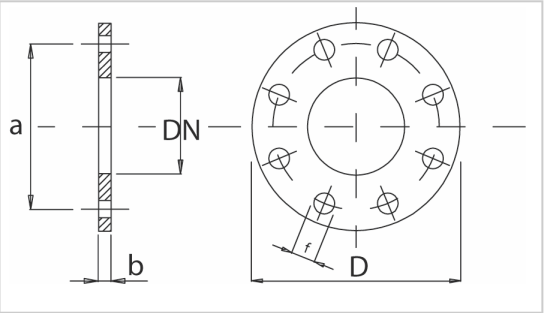

Flange Dimensions - EN-1092-1:2001											
Size	Pressure	D	a	b					f		
DN	PN	Outer diameter	Bolt diameter	Thickness [mm]				No. of holes	Hole diameter	Bolt size	Flange type
[mm]	[bar]	[mm]	[mm]	PN 6	PN 10	PN 16	PN 40		[mm]		
15	40	95	65				14	4	14	M12	01
20	40	105	75				16	4	14	M12	01
25	40	115	85				16	4	14	M12	01
32	40	140	100				18	4	18	M16	01
40	40	150	110				18	4	18	M16	01
50	16	165	125			19		4	18	M16	01
65	16	185	145			20		8	18	M16	01
80	16	200	160			20		8	18	M16	01
100	16	220	180			22		8	18	M16	01
125	16	250	210			22		8	18	M16	01
150	16	285	240			24		8	22	M20	01
200	16	340	295			26		12	22	M20	01
250	10	395	350		26			12	22	M20	01
300	10	445	400		26			12	22	M20	01
350	10	505	460		28			16	22	M20	01
400	10	565	515		32			16	26	M24	01

Flange Dimensions - EN-1092-1:2001											
Size	Pressure	D	a	b				f			
DN	PN	Outer diameter	Bolt diameter	Thickness [mm]				No. of holes	Hole diameter	Bolt size	Flange type
[mm]	[bar]	[mm]	[mm]	PN 6	PN 10	PN 16	PN 40		[mm]		
450	10	615	565		36			20	26	M24	01
500	10	670	620		38			20	26	M24	01
600	10	780	725		42			20	30	M27	01
700	10	895	840		38			24	30	M27	05
800	6	975	920	44				24	30	M27	05
900	6	1075	1020	48				24	30	M27	05
1000	6	1175	1120	52				28	30	M27	05
1200	6	1405	1340	60				32	33	M30	05
1400	6										
1600	6										
1800	6										
2000	6										

MagFlux Q sensor sizes and torque

MagFlux Q sensor sizes and torque information				
Size	DN50	DN80	DN100	DN150

Torque	30 Nm	40 Nm	40 Nm	50-55 Nm
---------------	-------	-------	-------	----------

The above table shows torque settings for plastic flanges, whether using metal or PVC counter flange. Make sure that your flanges are aligned correctly under the installation. If you are using EPDM/FKP/FPM or Viton gaskets, there is no reason for tightening above the limits. To avoid misalignment and further damage to the flanges, make sure that you are using washers on both flanges that are tightened together.

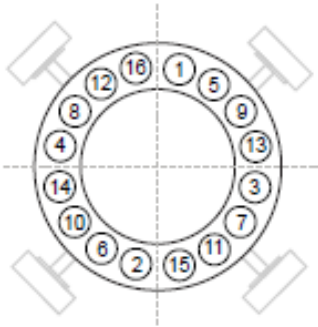

Tighten the nuts to the needed torque in the illustrated order. Tighten in four steps:

1. 30%
2. 60%
3. 100%
4. 100% clockwise from top

MJK standard flanges - ANSI B 16.5 - U.S.A.

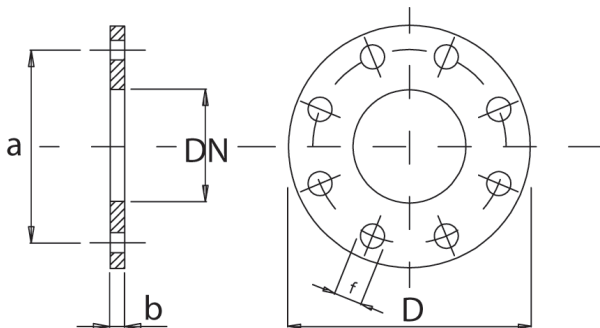

Flange Dimensions - ANSI B 16.5						
Size	Pressure class	D	a	b	No. of holes	f
		Outer diameter	Bolt diameter	Thick-ness		Hole diameter
[in]	[psi] 1)	[in]	[in]	[in]		[in]
½"	150	3.50	2.38	0.44	4	0.62
¾"	150	3.88	2.75	0.50	4	0.62
1"	150	4.25	3.12	0.56	4	0.62
1¼"	150	4.62	3.50	0.62	4	0.62
1½"	150	5.00	3.88	0.69	4	0.62
2"	150	6.00	4.75	0.75	4	0.75
2½"	150	7.00	5.50	0.88	4	0.75
3"	150	7.50	6.00	0.94	4	0.75
4"	150	9.00	7.50	0.94	8	0.75
5"	150	10.00	8.50	0.94	8	0.88
6"	150	11.00	9.50	1.00	8	0.88
8"	150	13.50	11.75	1.12	8	0.88
10"	150	16.00	14.25	1.19	12	1.00
12"	150	19.00	17.00	1.25	12	1.00
14"	150	21.00	18.75	1.38	14	1.12
16"	150	23.50	21.75	1.44	16	1.12
18"	150	25.00	22.75	1.56	16	1.25
20"	150	27.50	25.00	1.69	20	1.25

24"	150	32.00	29.50	1.88	20	1.38
Flange Dimensions - AWWA C207-01						
28"	Class D	36.50	34.00	1.31	28	1.38
32"	Class D	41.75	38.50	1.50	28	1.63
36"	Class D	46.00	42.75	1.63	32	1.63
40"	Class D	50.75	47.25	1.63	36	1.63
48"	Class D	59.50	56.00	1.89	44	1.63
1) 600-900 psi: Consult the factory.						

Flange Dimensions - ANSI B 16.5						
Size	Pressure class	D	a	b	No. of holes	f
		Outer diameter	Bolt diameter	Thickness		Hole diameter
[in]	[psi] 1)	[in]	[in]	[in]		[in]
1/2"	300	3.75	2.63	0.50	4	0.62
3/4"	300	4.62	3.25	0.56	4	0.75
1"	300	4.88	3.50	0.63	4	0.75
1 1/4"	300	5.25	3.87	0.69	4	0.75
1 1/2"	300	6.12	4.50	0.75	4	0.88
2"	300	6.50	5.00	0.81	8	0.75
2 1/2"	300	7.50	5.87	0.94	8	0.88
3"	300	8.25	6.63	1.06	8	0.88
4"	300	10.00	7.87	1.19	8	0.88

5"	300	11.00	9.25	1.31	8	0.88
6"	300	12.50	10.63	1.38	12	0.88
8"	300	15.00	13.00	1.56	12	1.00
10"	300	17.50	15.25	1.81	16	1.12
12"	300	20.50	17.75	1.94	16	1.25
14"	300	23.00	20.25	2.06	20	1.25
16"	300	25.50	22.50	2.19	20	1.38
18"	300	28.00	24.75	2.31	24	1.38
20"	300	30.50	27.00	2.44	24	1.38
24"	300	36.00	32.00	2.69	24	1.63

Flange Dimensions - AWWA C207-01

28"	Class E	36.50	34.00	2.06	28	1.38
32"	Class E	41.75	38.50	2.25	28	1.63
36"	Class E	46.00	42.75	2.38	32	1.63
40"	Class E	50.75	47.25	2.50	36	1.63
48"	Class E	59.50	56.00	2.75	44	1.63

1) 600-900 psi: Consult the factory.

MJK standard flanges - AS-4087-2004 - Australia

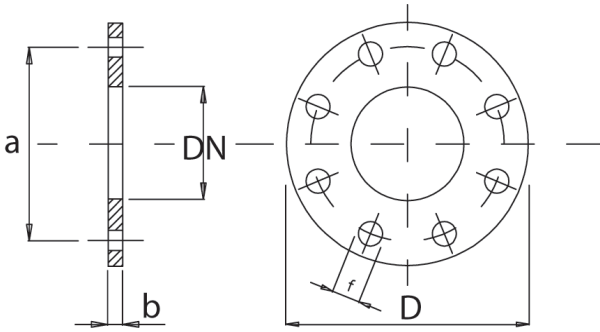

Flange Dimensions - PN 16 - AS-4087-2004					
Size	D	a	b	No. of holes	f
DN	Outer diameter	Bolt diameter	Thick-ness		Hole diameter
[mm]	[mm]	[mm]	[mm]		[mm]
15	95	67	6	4	14
20	100	73	6	4	14
25	115	83	8	4	14
32	120	87	8	4	14
40	135	98	10	4	14
50	150	114	10	4	18
65	165	127	11	4	18
80	185	146	11	4	18
100	215	178	13	4	18
150	280	235	19	8	18
200	335	292	19	8	18
250	405	356	23	8	22
300	455	406	30	12	22
350	525	470	30	12	26
400	580	521	30	12	26
450	640	584	30	12	26
500	705	641	38	16	26

Flange Dimensions - PN 16 - AS-4087-2004					
Size	D	a	b	No. of holes	f
DN	Outer diameter	Bolt diameter	Thick-ness		Hole diameter
[mm]	[mm]	[mm]	[mm]		[mm]
600	825	756	48	16	30
700	910	845	56	20	30
800	1060	984	56	20	36
900	1175	1092	66	24	36
1000	1255	1175	66	24	36
1200	1490	1410	76	32	36

MJK standard flanges - AS-4087-2004 (continued #1)

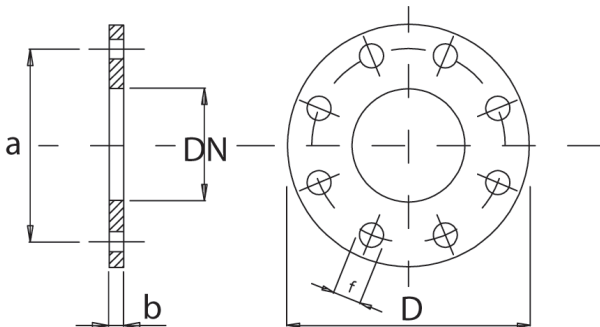

Flange dimensions - PN21 - AS 4087-2004					
Size	D	a	b	No. of holes	f
DN	Outer diameter	Bolt diameter	Thickness		Hole diameter
[mm]	[mm]	[mm]	[mm]		[mm]
15	95	67	10	4	14
20	100	73	10	4	14
25	120	87	10	4	18
32	135	98	13	4	18
40	140	105	13	4	18
50	165	127	15	4	18
65	185	146	15	8	18
80	205	165	15	8	18
100	230	191	19	8	18
150	305	260	24	12	22
200	370	324	24	12	22
250	430	381	30	12	26
300	490	438	30	16	26
350	550	495	38	16	30
400	610	552	38	20	30
450	675	610	38	20	33
500	735	673	48	24	33
600	850	781	58	24	36

Flange dimensions - PN21 - AS 4087-2004					
Size	D	a	b	No. of holes	f
DN	Outer diameter	Bolt diameter	Thickness s		Hole diameter
[mm]	[mm]	[mm]	[mm]		[mm]
700	935	857	58	24	36
800	1060	984	68	28	36
900	1185	1105	68	32	39
1000	1275	1194	78	36	39
1200	1530	1441	88	40	42

MJK standard flanges - AS-4087-2004 (continued #2)

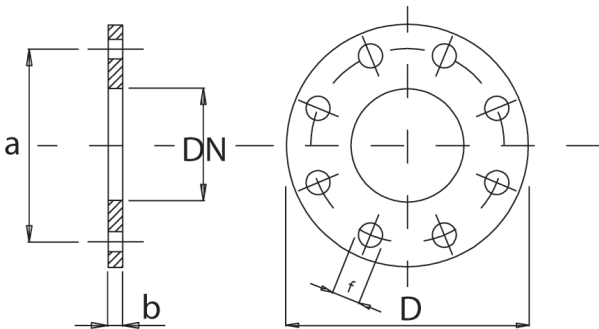

Flange dimensions - PN35 - AS-4087-2004					
Size	D	a	b	No. of holes	f
DN	Outer diameter	Bolt diameter	Thicknes s		Hole diameter
[mm]	[mm]	[mm]	[mm]		[mm]
20	115	83	13	4	18
25	120	87	14	4	18
32	135	98	17	4	18
40	140	105	17	4	18
50	165	127	19	4	18
65	185	146	19	8	18
80	205	165	24	8	18
100	230	191	24	8	18
150	305	260	31	12	22
200	370	324	31	12	22
250	430	381	38	12	26
300	490	438	38	16	26
350	550	495	48	16	30
400	610	552	48	20	30
450	675	610	58	20	33
500	735	673	58	24	33
600	850	781	68	24	36

Flange dimensions - PN35 - AS-4087-2004					
Size	D	a	b	No. of holes	f
DN	Outer diameter	Bolt diameter	Thickness		Hole diameter
[mm]	[mm]	[mm]	[mm]		[mm]
700	935	857	78	24	36
800	1060	984	84	28	36
900	1185	1105	94	32	39
1000	1275	1194	98	36	39
1200	1530	1441	108	40	42

Appendix A. Pop-up and error messages

Alarms	
Sensor error	The converter has experienced HW problems measuring flow (see log for details/time)
Sensor cal. code error	The calibration code conflicts with the sensor HW
Output coil error	The converter has experienced problems with connection to the sensor coil (see log for details/time)
Empty pipe	The converter has detected no water in the sensor
Input over range	Sensor flow can not be measured correct. Input is over max. level. Will normally only occur starting from zero flow to high flow. Will be present for max. 12 minutes
Factory reset has occurred	A factory reset has occurred (some settings have changed, check all used settings)
EEprom write error	EEprom write error (see log for details)
Flow total counter EEprom error	Flow totalize EEprom error (non-resettable counter maybe incorrect in EEprom)
Sensor setting error	Sensor Setting error (some settings are incorrect or changed)
Counter output forward pulsoverflow	Counter output Forward Pulse overflow (too low pulse volume)
Counter output reverse pulsoverflow	Counter output Reverse Pulse overflow (too low pulse volume)
Batch counter pulsoverflow 1	Batch1 counter overflow (counter has restarted form zero)

Alarms	
Batch counter pulsoverflow 2	Batch2 counter overflow (counter has restarted form zero)
Flow totalizer overflow	Flow totalize overflow (non-resettable counter maybe incorrect in EEprom)
mA error	Current out not connected (if the current out is used, deactivate Current out to stop this pop up)
mA flow error	Flow is over or under settings for current (it can be that flow is to high or negative)
Batch1 adaptive error	Batch 1 adaptive flow is over/under the limit for error correction
Batch2 adaptive error	Batch 2 adaptive flow is over/under the limit for error correction
Low flow	Low flow is detected
High flow	High flow is detected

Events	
Sensor auto cal.	Hold of flow output value because of auto calibration in converter (Normal)
Batch1 ended	Batch 1 has finished
Batch2 ended	Batch 2 has finished
System reset has occurred	The converter has experienced a software or hardware reset (normal if the sensor number has been changed)

Exceptions	
Illegal function	ModBus function is not supported
Illegal address	The address is not valid

Exceptions	
Illegal format	Data has an illegal format
Illegal data value	Data has a non-valid value
Missing user login	User password required to access
Missing service technician login	Xxx password required to access
Relay used for pulse counter positive	The relay is already in use by another function. Select a different relay
Relay used for pulse counter negative	The relay is already in use by another function. Select a different relay
Used for resettable totalizer total	The relay is already in use by another function. Select a different relay
Used for batch counter 1	The relay is already in use by another function. Select a different relay
Used for batch counter 2	The relay is already in use by another function. Select a different relay
Used for low flow	The relay is already in use by another function. Select a different relay
Used for high flow	The relay is already in use by another function. Select a different relay
Used for flow direction	The relay is already in use by another function. Select a different relay
Used for empty pipe	The relay is already in use by another function. Select a different relay

USB	
Flash programming please wait	Programming is in progress but not finished

USB	
Flash programming done	Programming is finished
Flash crc error	Cyclic redundancy check error
Unknown command flash user text	Invalid command issued
Flash address overrun	A write error has occurred
File phase error	Internal USB error
File write failure	A write error has occurred
USB protocol overrun	A communication error has occurred

Appendix B. MJK Field Link™ software

The **MJK Field Link™** software package provides several utilities that is described in detail in the manual regarding **MJK Field Link™** which is embedded in the software under **Help**.

Important:

1. Current MagFlux® log data must be saved in a file before transferring and installing new firmware.
2. Note down all display and converter settings before upgrading new firmware.

System Requirements MJK Field Link™

- Microsoft Windows XP sp2/ Vista /Win 7, 32/64bit, Windows 10.
- Updated Java package
- USB 2.0 connection, use with USB cable 691095

Download MJK Field Link™ and connect a PC to the MagFlux® flow meter

Download the **FIELD LINK 32BIT BUILD 150809.ZIP** or **FIELD LINK 64BIT BUILD 150809.ZIP file** from here: [Download Center](#)². Save it on your PC and unzip it. The unzipped folder contains the file **MJK Field Link EXE**-file and the manual regarding the software. Execute the **MJK Field Link EXE**-file.

² <https://mjk.com/download-center?mainCatId=3103&catId=3266&lang=english>



1. Unscrew the four screws that hold the display unit.
2. Lift out the display unit and connect a USB mini A/B cable to the mini USB female B connector on the rear of the front panel.
3. Connect the other end of the USB cable (max. 4.7 meters long) to the PC.
4. Select **File** in the menu bar and click **Connect**. If the connection is successful, a **Device Clock** window for PC and device time synchronization is displayed (if PC and device clock were out of sync.) along with a link status display (see next image).
5. If the connection fails, first remove the cable and then re-connect it.

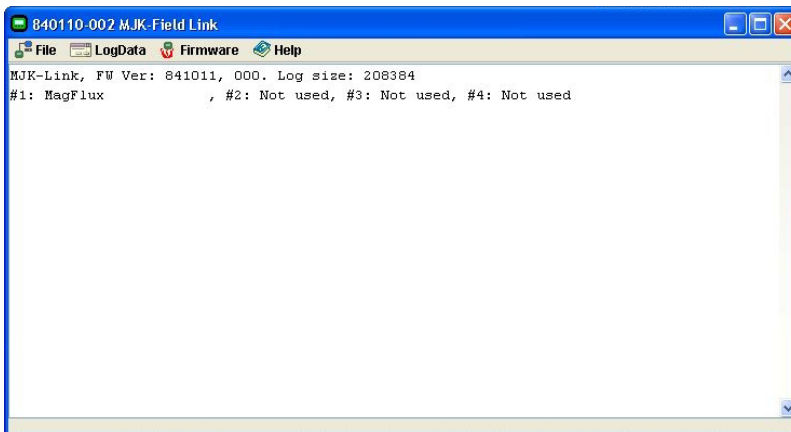

For further details, read the embedded manual regarding **MJK Field Link™**.

Save log data

1. Select **LogData** in the menu bar and click **Save Log to File**.
2. Assign a file name, find the destination you want to save the file to, and click **Save**. Consequently, the file is saved, and the contents is displayed.

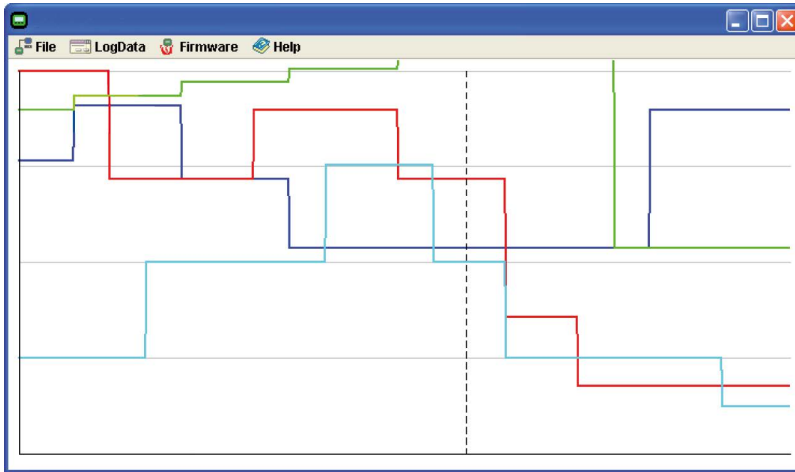

Upgrade display firmware.

Important: Always upgrade the display firmware before you upgrade the converter software.

1. Select **Firmware** in the menu bar and click **Display**.
2. Locate the display firmware **84xxxx-xxx Display firmware.hex** file (or a similar 84xxxx.hex file) and click **Open** (or contact support).
3. Click **OK** when the **Display Firmware** dialogue box appears and prompts for programming the display Flash memory.



The display unit firmware is then transferred, and the display unit is consequently programmed. Expect this process to take a few minutes.

4. A **Searching for Field** dialogue box then appears and prompts for disconnecting and re-connecting the USB cable. Do as suggested and click **OK**.



5. Meanwhile the MagFlux® Display Unit restarts and displays the logo, the new link status is displayed, and the Display Unit informs that the PC is once again connected. Click **OK** on the PC and the MagFlux® Display Unit to return to the MagFlux® Flow/FTot display.
6. Save the new setting by again pressing the two outmost keys simultaneously.

Upgrade converter firmware

1. Select **Firmware** in the menu bar and click **Converter**.
2. Locate the **FW** directory, select the 84xxx-xxx.hex file (or similar) and click **Open**.
3. Select the required MagFlux® (option 1, 2, 3 or 4) and click **OK** when the **Converter Firmware** dialogue box appears and prompts for selecting the converter to program. The converter firmware is then transferred, and the converter Flash programming is initiated. Expect this process to take a few minutes.

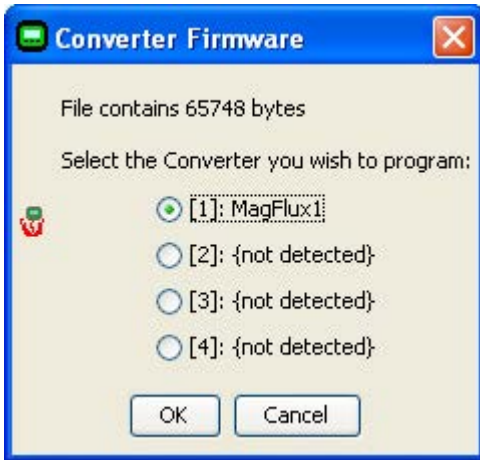

4. When the Flash programming is done, click **OK** on the PC and the MagFlux® Display Unit to return to the MagFlux® Flow/FTot display.
5. If required you may adjust the MagFlux® Display Unit screen contrast by pressing the two outmost keys simultaneously, press the up/down keys as required, and save the new setting by again pressing the two outmost keys simultaneously.

Install/Add languages

All languages are removed during a display firmware upgrade. Consequently the required languages must be re-installed at this stage.

1. Select **File** in the menu bar and click **Languages**.
2. A dialogue appears showing the currently installed languages (none following a firmware upgrade). You can now either add or delete the required languages.
3. Click **Add**, select the required language text file in the **Field Display Unit text files** directory on the PC (for example 841511-000.txt) and click **Open**.
4. Select for example **European N + W** in the **Add Language** dialogue box (N + W = Northern and Western) and click **OK**.



5. The languages are then transferred and loaded. If required, you can remove one or more languages by selecting them from the list, clicking **Delete** and **Close**.

Appendix C. FAQs

Question: Which size MagFlux® flow meter should I choose for my installation? I would prefer a flow meter with the same diameter as the tube(s).

Answer: The minimum and maximum flows determine the size. Use the [Sizing chart](#) (see page 20) to find the correct flow meter size, and avoid selecting a too large size.

Question: Where do I install the MagFlux® flow meter in relation to valves, bends, pumps, etc.?

Answer: Minimum three times the MagFlux® flow meter's internal diameter (DN) up-stream, and minimum two times its internal diameter (DN) down-stream.

Question: Must the tube be completely filled with liquid to perform reliable flow measurements?

Answer: Yes. Always ensure a filled tube.

Question: Do I need a separate display unit for each sensor?

Answer: No. A display unit can manage up to four converters.

Question: Is the analogue mA output an active output?

Answer: Yes, it is.

Question: The tubes are made of plastic. Do I need grounding rings?

Answer: We recommend that you always use two grounding rings. Furthermore, see [Potential equalization and grounding](#) (see page 28).

Question: Are the relays potential-free?

Answer: Yes, they are.

Question: Does the sensor/flow meter comply with IP68?

Answer: It will once you employ a wall mounting kit, a special cable and a gel potting kit to protect the electrical connections.

Question: Can I use a MagFlux® flow meter to measure non-conductive liquids such as diesel oil?

Answer: No. The electromagnetic principle presupposes conductivity. The conductivity limit is 5 µS/cm.

Question: I have an "Empty pipe" indication, but the pipe is not empty!

Answer: There are no grounding rings, or the rings have not been properly grounded. See examples in [Potential equalization and grounding](#) (see page 28).

Question: I can't set the counter to the required output, only to a value that is higher. Why is that?

Answer: The measuring range does not support a sufficient number of pulses at 100%

flow. The solution is to adjust the mA output to a lower flow and to keep in mind that the max. flow is not exceeded (< 20 mA).

Question: I do not understand the language on the display. What's wrong and how do I fix it?

Answer: For example lightning and a too noisy environment can have caused the problem.

The solution is to perform a system reset by pressing all four display keys simultaneously. The default language, English, will consequently be the display language (that you can change to your native language if required).

Question: Can I always allow up to 50 meters between the sensor and the converter?

Answer: It really depends on the cabling and the amount of electrical noise in the vicinity. Avoid running in parallel with high voltage and other power lines. If that is not possible, the converter must be installed closer to the sensor.

Appendix D. Front panel cut-out drawing

The below is a representation of a cut-out drawing for the MagFlux® front panel.

The dotted line indicates the front panel outline and measures 155 x 145 mm or 6.10 x 5.71 inches. These measurements of the downloaded version are valid when printed in a 100% scale. However, as some printers might shrink images when printing, it is recommended to measure the drawing after printing to ensure that it has maintained the correct measurements.

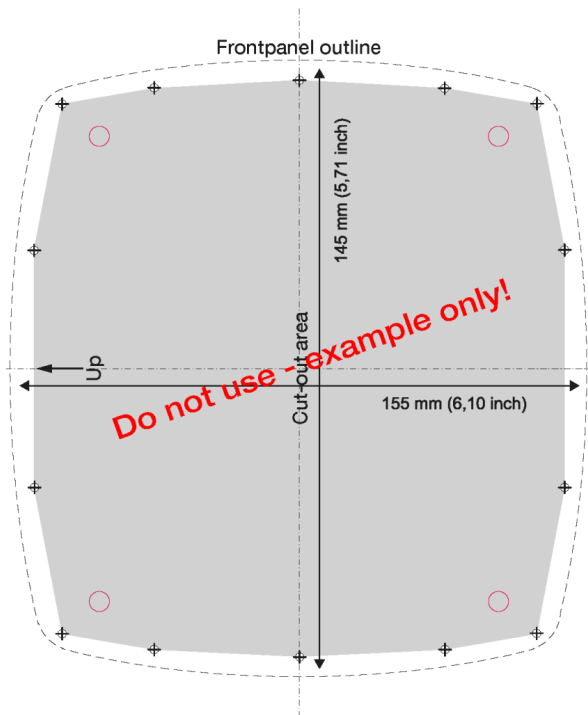

MJK cut-out download

The real-size drawing can be downloaded for A4 and letter format here: [Download Center](#)³.

³ <https://mjk.com/download-center?mainCatId=3103&catId=3266&lang=english>

Appendix E. MJK test certificate

TEST CERTIFICATE

MagFlux® Flow Meter

FLOW SENSOR

Part no.: **207222**
Serial no.: **23734**
Calibration code: **au2921**

SENSOR SPECIFICATIONS

Size: **DN50**
Protection: **IP67**
Pressure rating: **PN16**
Lining: **Hard rubber**
Electrodes: **AISI 316 TI**
Media temperature: **-10 to 80°C**

Test conditions:

The meter tests were carried by a gravimetric method, with a long start.

Test facility:

Helios AG, Silesia, equipped with several weighing machines of capacities 4800 kgs production serial numbers 9229012, 47583.

Last calibration date: 17th December 2006, calibration sheets No. 305-KL-V347-06.

Test results:

Deviation 0,09 % at a velocity of 0,5 m/s
Deviation 0,01 % at a velocity of 1,5 m/s
Deviation 0,00 % at a velocity of 6,5 m/s

DATE

31 January 2007

SIGNATURE



Appendix F. Log files

The example log file shown below is the result of a CSV file from the converter having been opened in with Microsoft® Excel® spread sheet utility. This example in the following illustrates four MagFlux® converters being logged every 10 secs.

Microsoft Excel - log file example.csv

File Edit Format View Window Help

100% Arial

	A	B	C	D	E	F	G	H	I	J	K	L
	Index	MB Address	Unit	Value ID	Device Type	Frequency	Range Max	Range Min	Precision			
1												
2	32		19	600		2	10	0,002777778	0	0,000001	00560041004e00440020004e00600720064	
3	34		3	19	600	2	10	0,002777778	0	0,000001	0044004c004400410044002000500790064	
4	33		2	19	600	2	10	0,002777778	0	0,000001	0053004e004100440020005006500730074	
5	35		4	19	600	2	10	0,002777778	0	0,000001	039c0391039303a6039003903903a0c039e	
6												
7	Index	Time	UTime	SI Value								
8	32	2006-08-28 15:31:36	CEST	1,15678E+12								
9	33	2006-08-28 15:31:36	CEST	1,15678E+12								
10	34	2006-08-28 15:31:36	CEST	1,15678E+12								
11	35	2006-08-28 15:31:36	CEST	1,15678E+12								
12	32	2006-08-28 15:31:46	CEST	1,15678E+12								
13	33	2006-08-28 15:31:46	CEST	1,15678E+12								
14	34	2006-08-28 15:31:46	CEST	1,15678E+12								
15	35	2006-08-28 15:31:46	CEST	1,15678E+12								
16	32	2006-08-28 15:31:56	CEST	1,15678E+12								
17	33	2006-08-28 15:31:56	CEST	1,15678E+12								
18	34	2006-08-28 15:31:56	CEST	1,15678E+12								
19	35	2006-08-28 15:31:56	CEST	1,15678E+12								
20	32	2006-08-28 15:32:06	CEST	1,15678E+12								
21	33	2006-08-28 15:32:06	CEST	1,15678E+12								
22	34	2006-08-28 15:32:06	CEST	1,15678E+12								
23	35	2006-08-28 15:32:06	CEST	1,15678E+12								
24	32	2006-08-28 15:32:16	CEST	1,15678E+12								
25	33	2006-08-28 15:32:16	CEST	1,15678E+12								
26	34	2006-08-28 15:32:16	CEST	1,15678E+12								
27	35	2006-08-28 15:32:16	CEST	1,15678E+12								
28	32	2006-08-28 15:32:26	CEST	1,15678E+12								
29	33	2006-08-28 15:32:26	CEST	1,15678E+12								
30	34	2006-08-28 15:32:26	CEST	1,15678E+12								
31	35	2006-08-28 15:32:26	CEST	1,15678E+12								
32	32	2006-08-28 15:32:36	CEST	1,15678E+12								
33	33	2006-08-28 15:32:36	CEST	1,15678E+12								
34	34	2006-08-28 15:32:36	CEST	1,15678E+12								
35	35	2006-08-28 15:32:36	CEST	1,15678E+12								
36	32	2006-08-28 15:32:46	CEST	1,15678E+12								
37	33	2006-08-28 15:32:46	CEST	1,15678E+12								
38	34	2006-08-28 15:32:46	CEST	1,15678E+12								
39	35	2006-08-28 15:32:46	CEST	1,15678E+12								

Log file example /

Klar

The entries are described on the following section.

- **Index:** Converter ID (here 4 converters: 32, 33, 34 and 35)
- **MB Address:** Modbus address (here: 1, 2, 3 and 4)
- **Unit:** SI unit according to the unit codes (here: 19 = m³/h)

Unit Codes		
Code no.	Unit	
16	GPM	gallons per minute
17	l/min	litres per minute
19	m ³ /h	cubic meters per hour
23	MGD	million gallons per day
24	l/sec	litres per second
28	m ³ /sec	cubic meters per second
57	%	percent
95	mg/l	milligrams per litre
96	kg/l	kilograms per litre
97	g/l	grams per litre
130	ft ³ /h	cubic feet per hour
138	l/h	litres per hour
139	ppm	parts per million
246	NTU	Nephelometric Turbidity Units
248	FNU	Formazin Nephelometric Units
249	EBC	European Brewing Convention
250	FTU	Formazine Turbidity Units

- **Value ID:** ModBus address for flow (here: 600)

- **Device Type:** The device type (here: 2 = MagFlux®)
- **Frequency:** Log interval in seconds (here: 10 seconds)
- **Range Max:** Maximum value for graph
- **Range Min:** Minimum value for graph
- **Precision:** The precision of the SI value
- **Column J:** The sensor name as entered by the operator.
- **Time:** Date and time in Central European Standard Time (CEST)
- **UTime:** The time in UNIX format. Number of seconds since January 1, 1970
- **SI Value:** The value in SI units (Système International d'Unités) (here: m³/h)

To plot the log file's data, proceed as follows:

1. Start Excel and open the csv log file.
2. Sort by Index, click the **Diagram Guide** tool in the toolbar and select the required curve or graph (see example below).

32

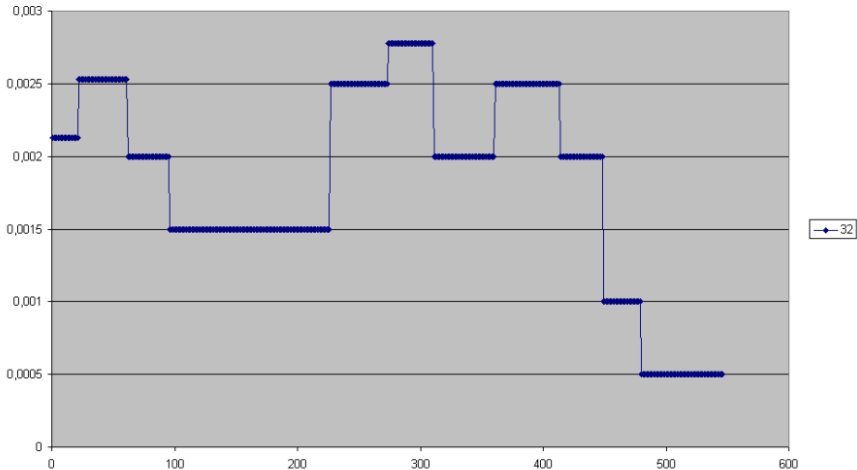

Appendix G. Digital input/output connections

The digital in- and outputs, DI and DO, can be interconnected to external equipment to achieve a number of functions such as alarms, counter reset, flow direction indication, etc.

The two schematics below illustrate a simplified mode of operation.

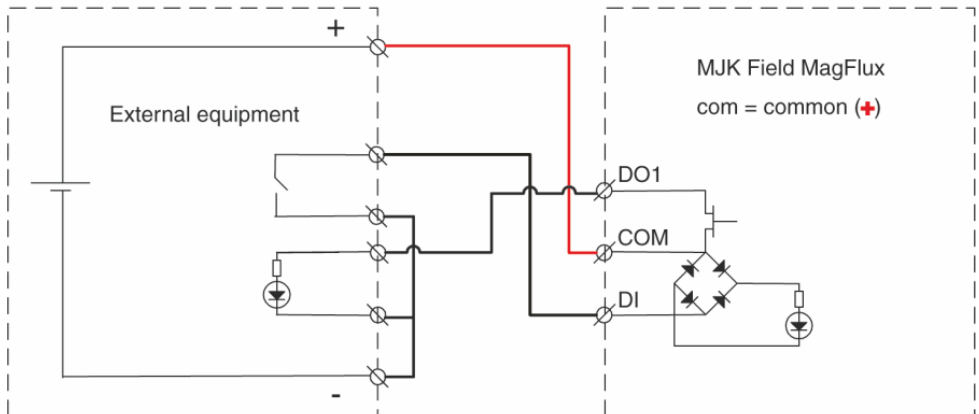
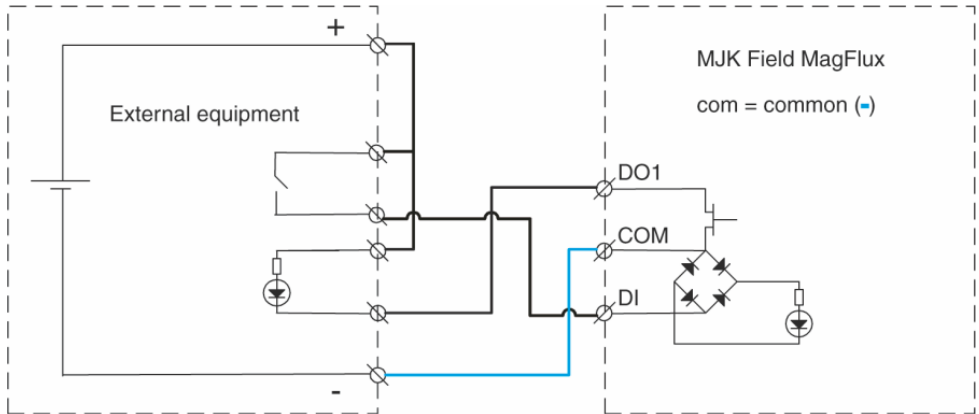

Appendix H. Remote slave display unit

This example describes the cable connections and display configurations for one MagFlux® converter with a local "master" display unit and one remote "slave" display unit.

Connection board for remote slave display unit

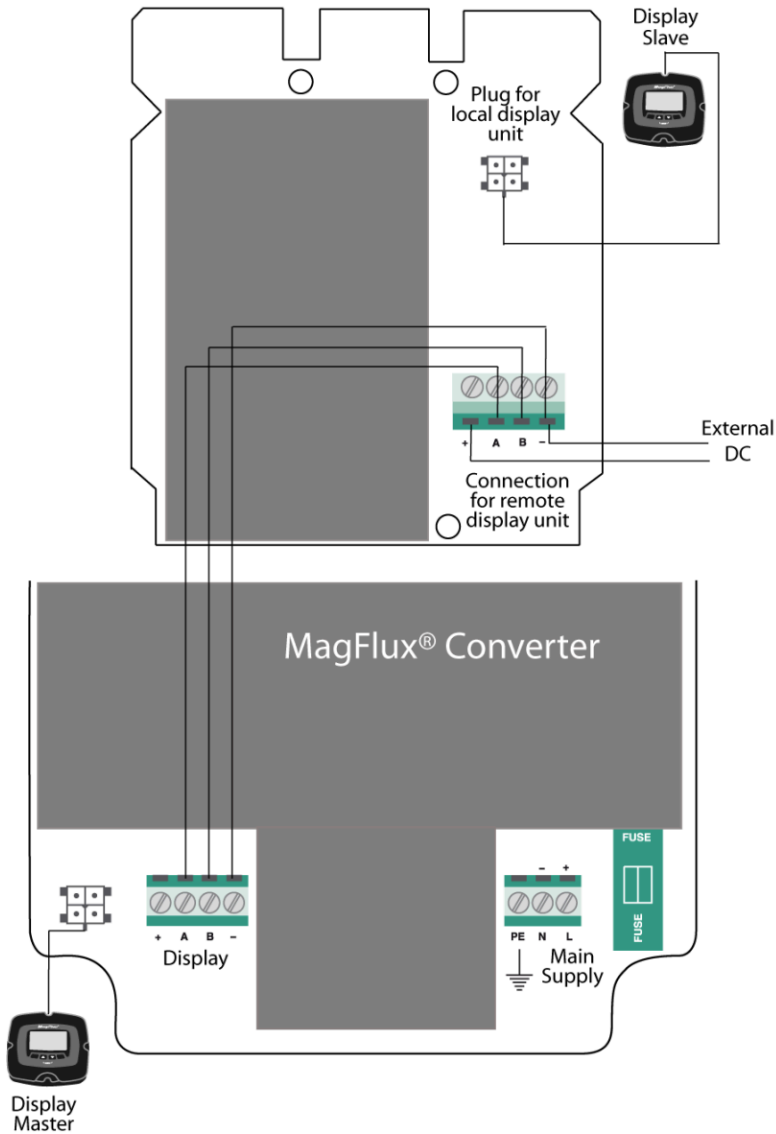

Converter connection board with master display unit

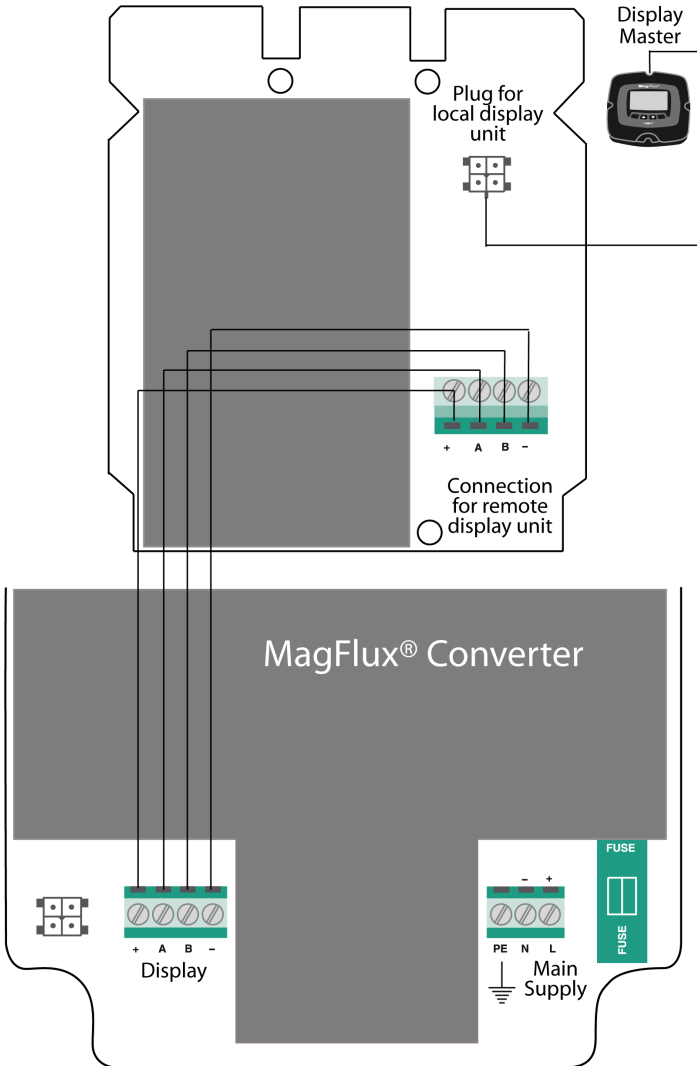

Wiring

1. Connect a lead between: **Display, A** on the Converter Connection Board to **Connection for remote display unit, A** on the Connection Board.
2. Connect a lead between: **Display, B** on the Converter Connection Board to **Connection for remote display unit, B** on the Connection Board.
3. Connect a lead between: **Display, -** on the Converter Connection Board to **Connection for remote display unit, -** on the Connection Board.
4. Connect a lead between: **Mains supply, L** on the Converter Connection Board to **Connection for remote display unit, +** on the Connection Board.
5. Connect a lead between: **Mains supply, N** on the Converter Connection Board to **Connection for remote display unit, -** on the Connection Board.
6. Connect two leads between: **Mains supply, L and N** on the Converter Connection Board to an external 10 - 30 V DC power supply
7. Connect the earth terminals to earth as required.
8. Turn on power (10 - 30 V DC) to the Converter Connection Board.

Configuration for the master unit

1. Press **Setup** and select **Display Setup**.
2. Select **Modbus** and **Change Display ID No.**
3. Change the display ID no. to **1** (if different from **1**).
4. Change the **Number of Displays** to **2**.

Configuration for the slave unit

1. Press **Setup** and select **Display Setup**.
2. Select **Modbus** and **Change Display ID No.**
3. Change the display ID no. to **2**.
4. Change the **Number of Displays** to **2**.

Main menu overview

The size of this manual does not provide sufficient space for showing the complete, contiguous menu structure. As a compensation, a cut-up presentation of the main-menu structure is shown here and relevant sub-menus in the following sections.

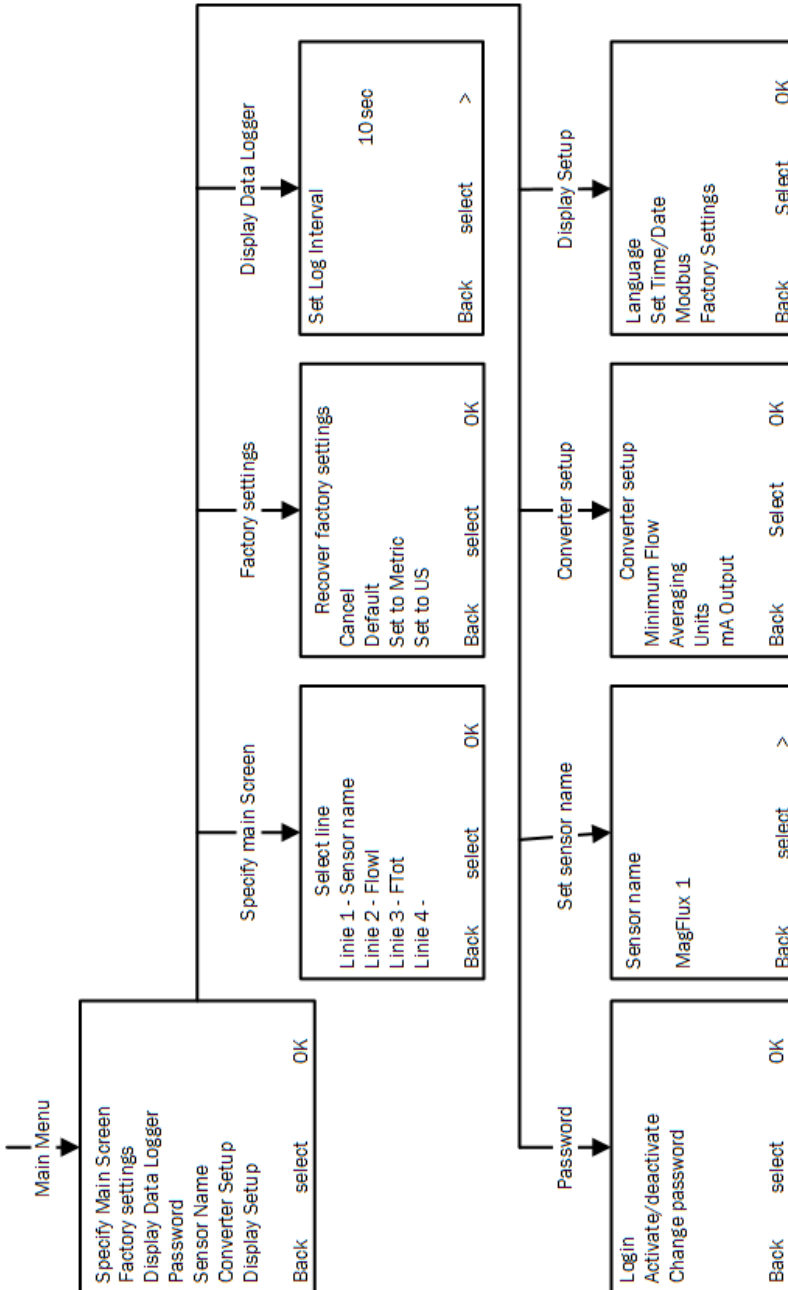

Converter setup menu overview

The size of this manual does not provide sufficient space for showing the complete, contiguous menu structure. As a compensation a cut-up presentation of the menu structure is shown.

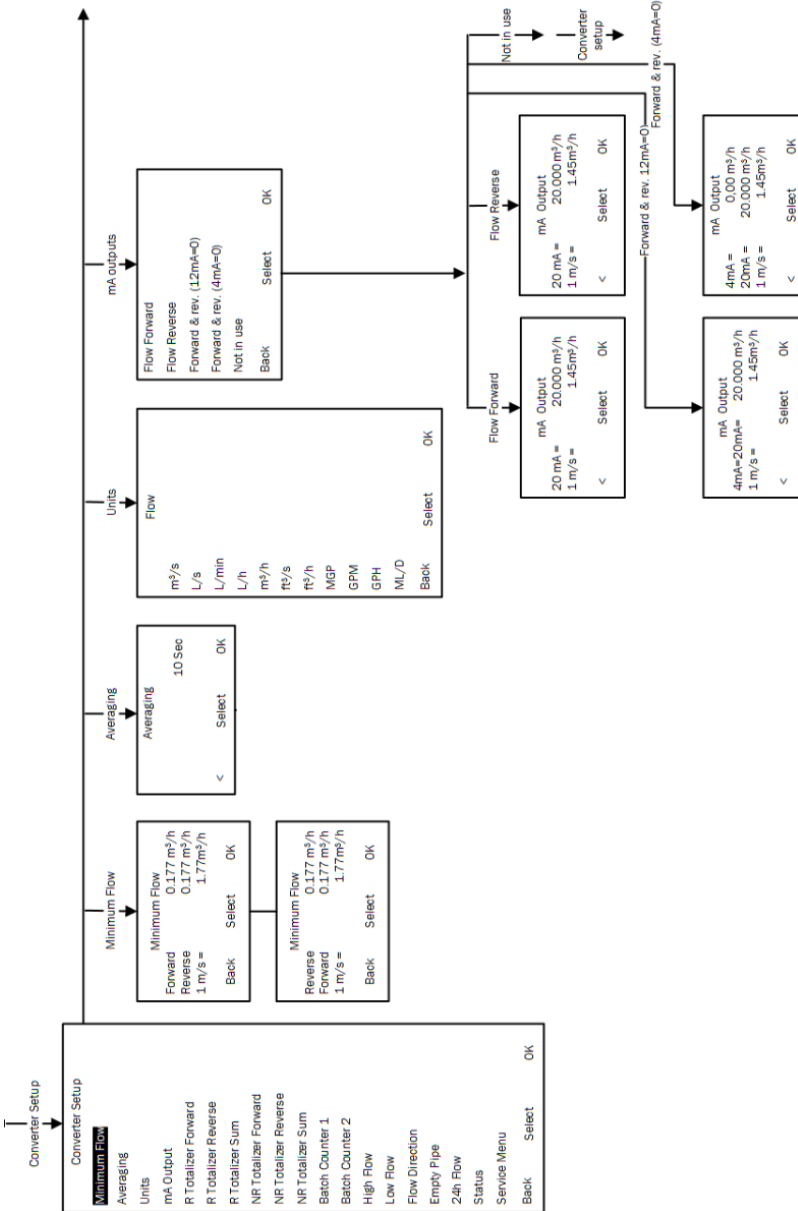

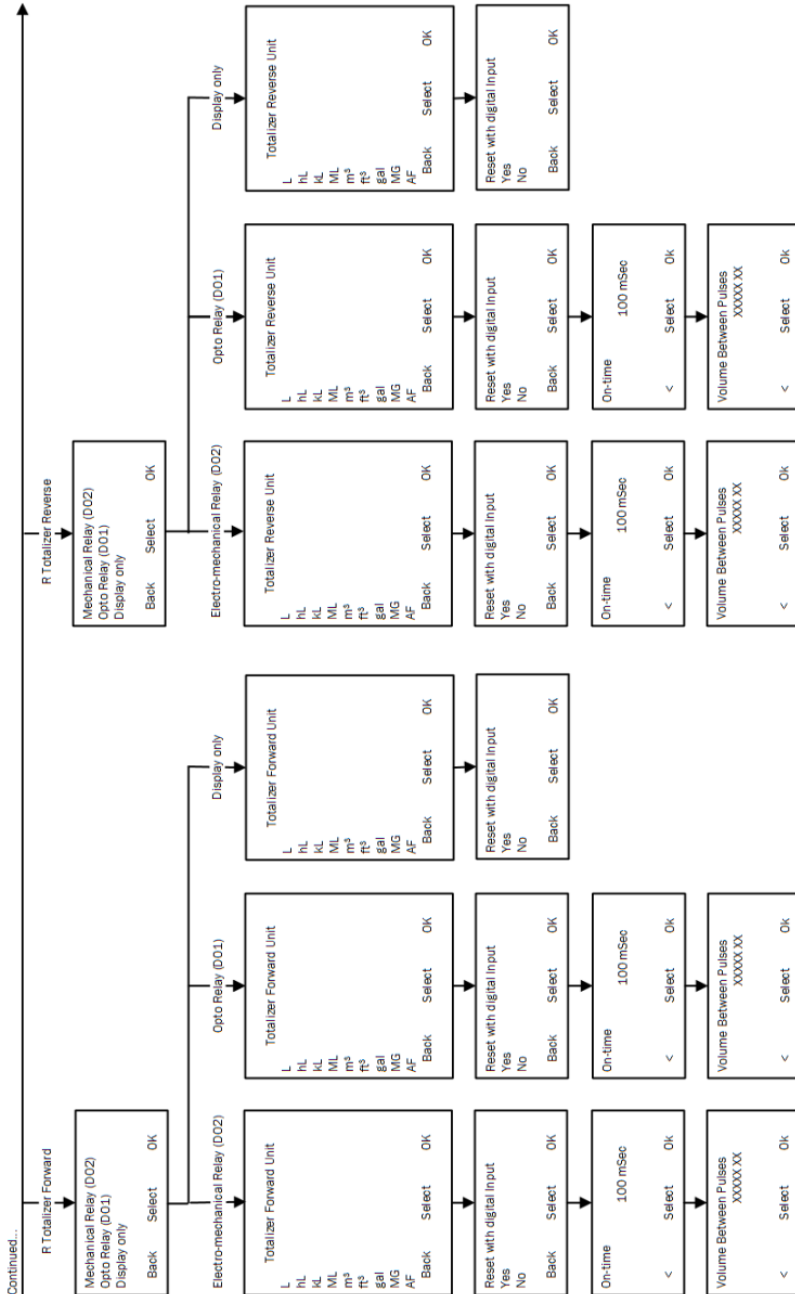

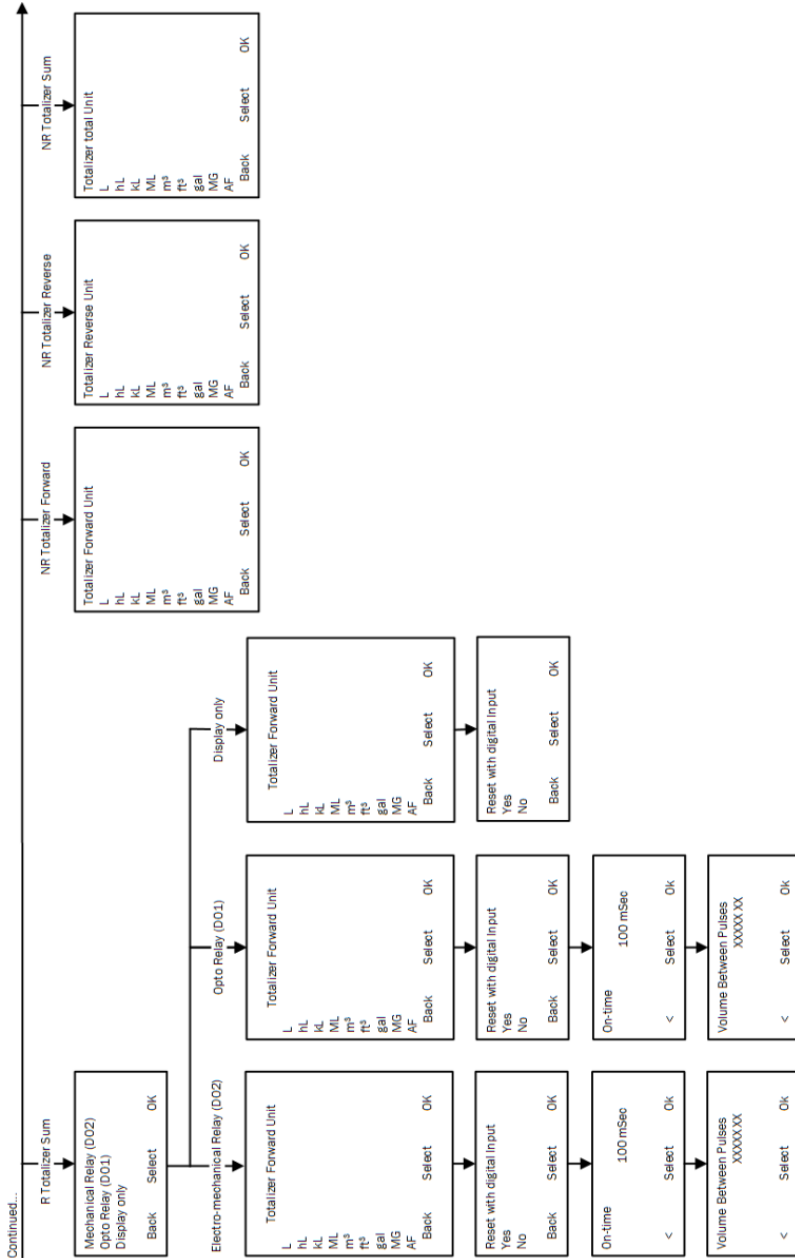

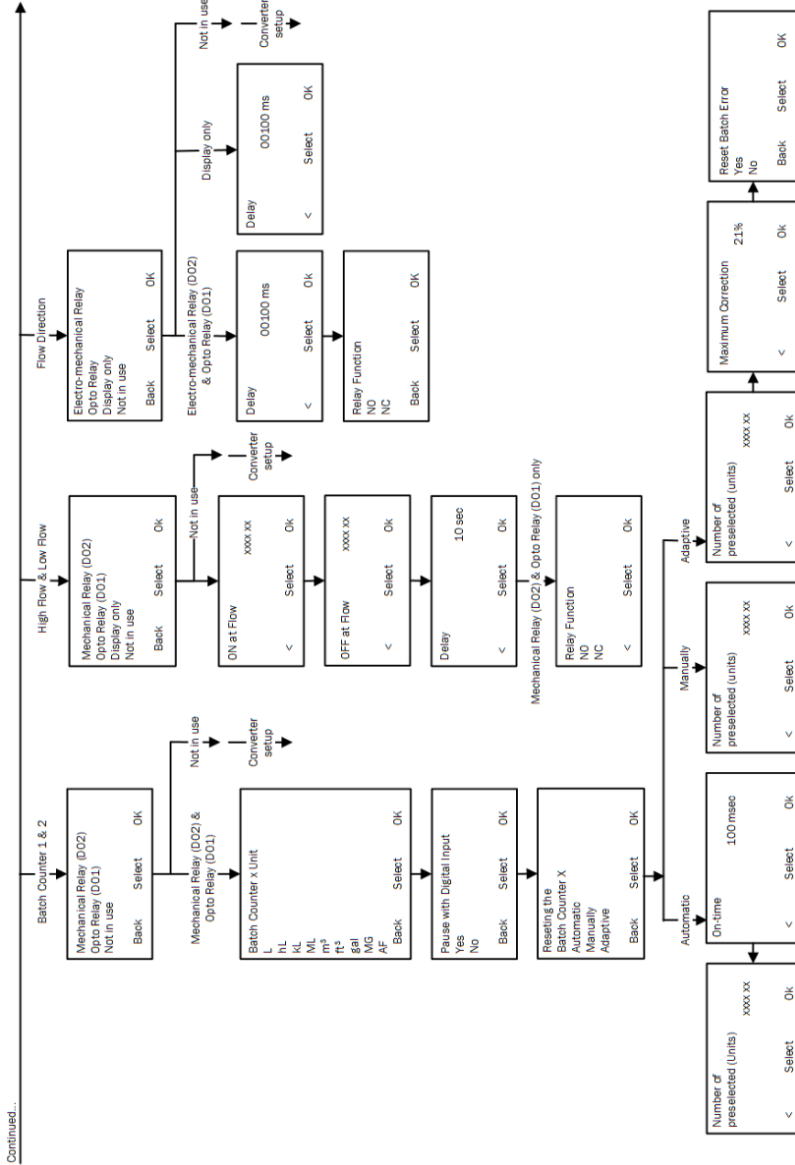

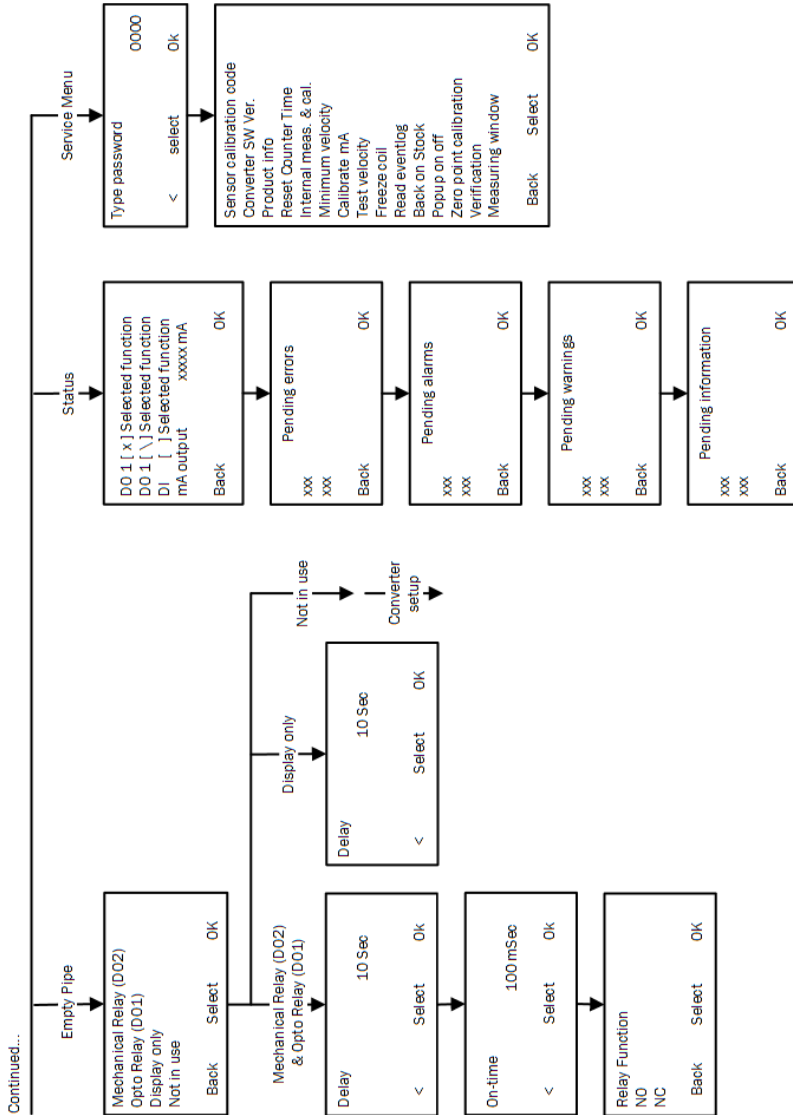

Service menu overview

The size of this manual does not provide sufficient space for showing the complete, contiguous menu structure. As a compensation a cut-up presentation of the menu structure is shown.

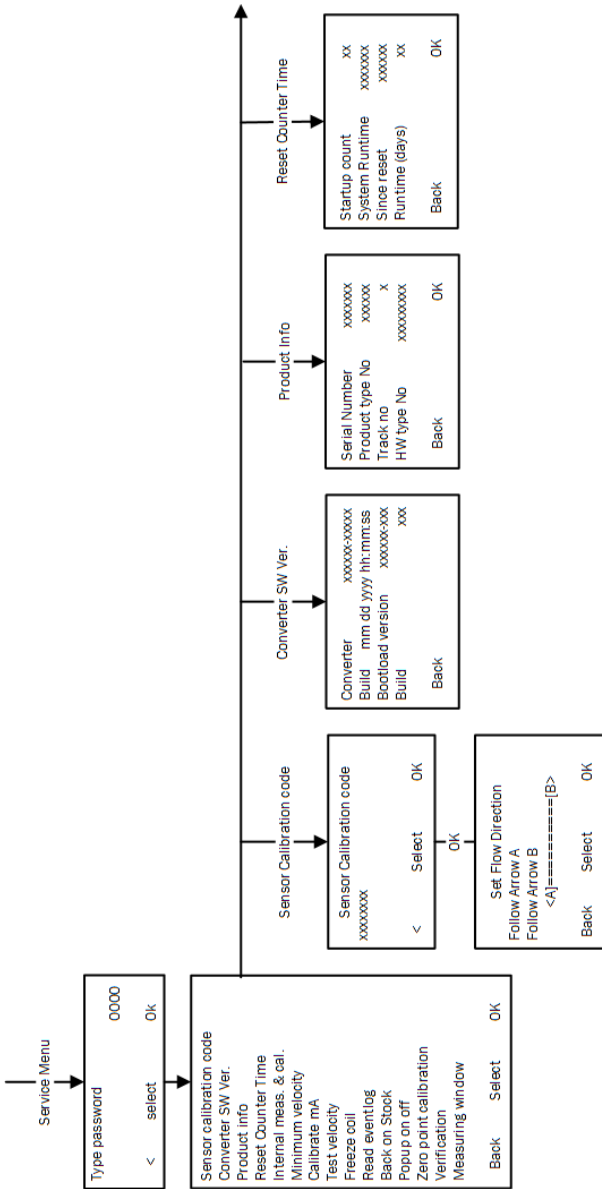

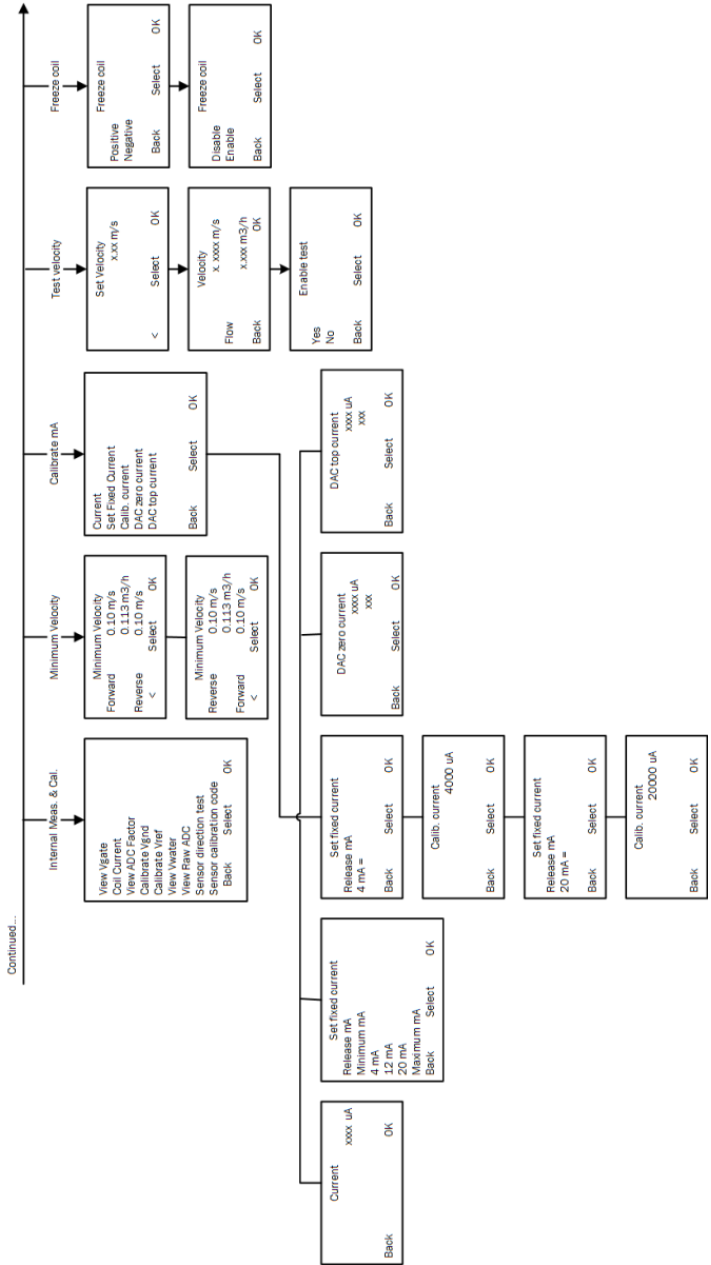



Menu items under Zero point calibration and Verification are for future usage only

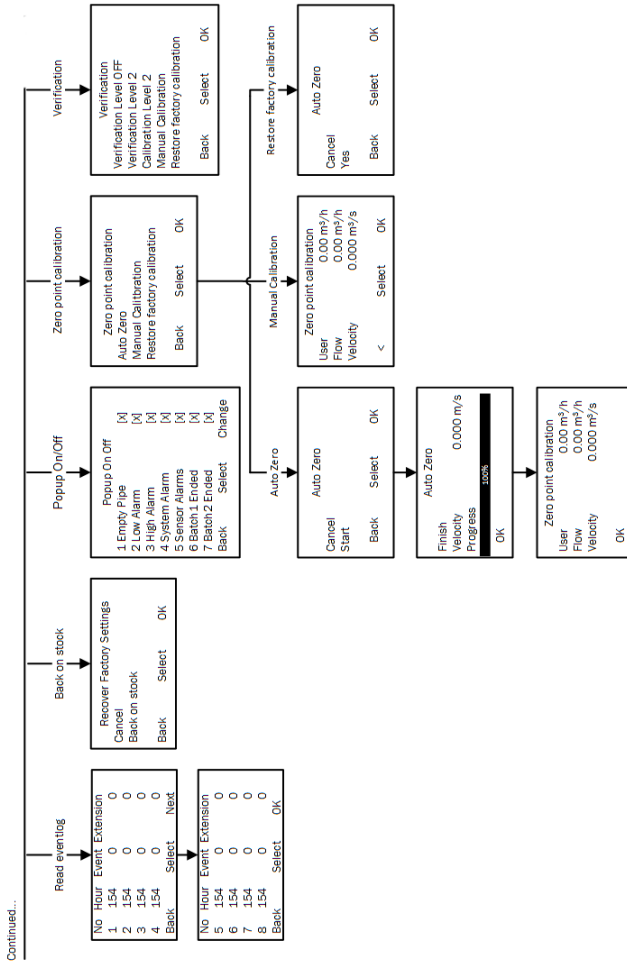

Display setup menu overview

The size of this manual does not provide sufficient space for showing the complete, contiguous menu structure. As a compensation a cut-up presentation of the menu structure is shown.

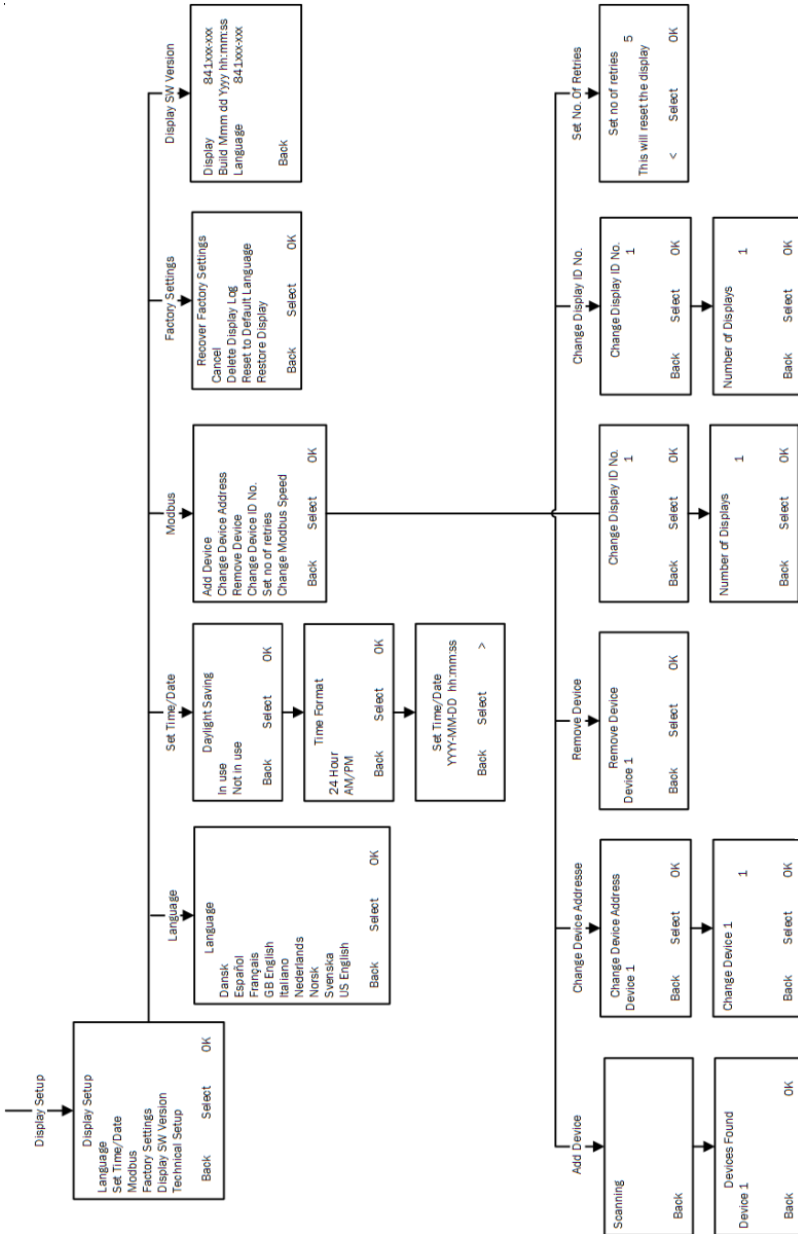

Xylem | 'zīləm|

- 1) The tissue in plants that brings water upward from the roots;
- 2) a leading global water technology company.

We're 12,700 people unified in a common purpose:

creating innovative solutions to meet our world's water needs. Developing new technologies that will improve the way water is used, conserved, and re-used in the future is central to our work.

We move, treat, analyze, and return water to the environment, and we help people use water efficiently, in their homes, buildings, factories and farms. In more than 150 countries, we have strong, long-standing relationships with customers who know us for our powerful combination of leading product brands and applications expertise, backed by a legacy of innovation.

For more information on how Xylem can help you, go to www.xylem.com



MJK Automation ApS
Blokken 9
DK-3460 Birkerød
Denmark
Tlf +45 45 56 06 56

www.mjk.com

Connect, M μ Connect, Chatter, MagFlux, Oxix, pHix compact, Shuttle and SuSix are registered trademarks of MJK Automation ApS.
© 2021 Xylem, Inc



