

Operating instructions

Solenoid Metering Pump

gamma/ X, GMXa

EN



Target group: at least "instructed personnel" unless otherwise required.

**Please carefully read these operating instructions before use. · Do not discard.
The operator shall be liable for any damage caused by installation or operating errors.
The latest version of the operating instructions are available on our homepage.**

Supplementary information



Fig. 1: Please read!

Read the following supplementary information in its entirety! You will benefit more from the operating instructions should you already know this information.

The following are highlighted separately in the document:

■ Enumerated lists

➤ Instructions

⇒ Outcome of the instructions

🔗 *'State the identity code and serial number' on page 2*: Links to points in this chapter

- refer to ... : References to points in this document or another document

[Keys]

'Menu level 1 → Menu level 2 → Menu level ...': Menu paths

'Software interface texts'

Information



This provides important information relating to the correct operation of the unit or is intended to make your work easier.

Safety information

Safety information is identified by pictograms - see "Safety Chapter".

State the identity code and serial number

Please state the identity code and serial number, which you can find on the nameplate or in the menu under *'Setting / Menu → Information'* when you contact us or order spare parts. This enables us to clearly identify the unit type and material version.

General non-discriminatory approach

In order to make it easier to read, this document uses the male form in grammatical structures but with an implied neutral sense. It is aimed equally at both men and women. We kindly ask female readers for their understanding in this simplification of the text.

Table of contents

1	About this pump	6
2	Identity code	7
3	Safety chapter	10
	3.1 Labels.....	10
	3.2 Intended use.....	11
	3.3 Safety information.....	11
	3.4 Information in the event of an emergency.....	14
	3.5 Personnel qualification.....	14
4	Storage, Transport and Unpacking	16
5	Overview of equipment and control elements	17
	5.1 Overview of equipment.....	17
	5.2 Control elements.....	18
	5.2.1 Control elements.....	18
	5.2.2 Key functions.....	22
6	Functional description	24
	6.1 Liquid End.....	24
	6.2 Drive unit.....	24
	6.3 Capacity.....	26
	6.4 Self-Bleeding.....	26
	6.5 Operating modes.....	26
	6.6 Functions.....	27
	6.7 Relays (options).....	28
	6.8 LED displays.....	28
	6.9 Hierarchy of operating modes, functions and fault statuses.....	29
7	Assembly	30
8	Installation, hydraulic	32
	8.1 Installing hose lines.....	33
	8.1.1 Installation with metering pumps without degassing.....	33
	8.1.2 Installation with metering pumps with degassing.....	35
	8.1.3 Installation with metering pumps with self-degassing (SEK type).....	36
	8.2 Basic installation notes.....	37
9	Installation, electrical	39
	9.1 Supply voltage connector - power supply.....	40
	9.2 HMI operating unit.....	41
	9.3 Description of the terminals.....	41
	9.3.1 "External control" terminal.....	41
	9.3.2 "Level switch" terminal.....	43
	9.3.3 "Metering monitor" terminal.....	43
	9.3.4 "Diaphragm rupture indicator" terminal.....	44
	9.3.5 Relays.....	45
10	Basic set-up principles	49
	10.1 Basic principles for setting up the control.....	49
	10.2 Checking adjustable variables.....	51
	10.3 Changing to Setting mode.....	51

11	Set up / 'Menu'	52
11.1	'Information'.....	52
11.2	'Settings'.....	52
11.2.1	'Operating mode'.....	53
11.2.2	'Automatic'.....	58
11.2.3	'Stroke length'.....	58
11.2.4	Metering.....	59
11.2.5	Concentration.....	63
11.2.6	Calibrate.....	70
11.2.7	System.....	71
11.2.8	Inputs/outputs.....	73
11.2.9	Bleeding.....	79
11.2.10	'Priming time'.....	80
11.2.11	'Set time'.....	81
11.2.12	'Date'.....	81
11.3	Timer.....	81
11.3.1	Activation / deactivation.....	82
11.3.2	Setting the timer.....	82
11.3.3	Clear all.....	88
11.3.4	Examples.....	88
11.3.5	Timer information.....	90
11.3.6	Typical pitfalls Timer functional faults.....	90
11.3.7	Brief explanation of selected functions.....	91
11.4	'Service'.....	92
11.4.1	'Access protection'.....	92
11.4.2	'Password'.....	93
11.4.3	'Clear counters'.....	93
11.4.4	'Error log book'.....	93
11.4.5	'Diaphragm replacement'.....	94
11.4.6	'Display'.....	94
11.4.7	'Factory settings'.....	94
11.4.8	Diaphragm part number: XXXXXXXX.....	94
11.4.9	Spare parts kit part number: XXXXXXXX.....	94
11.5	'Language'.....	95
12	Operation	96
12.1	Manual operation.....	96
13	Maintenance	98
14	Repair	100
14.1	Replacing the diaphragm.....	101
14.1.1	Replacing the vPTFE diaphragm.....	103
14.2	Cleaning the diaphragm rupture indicator.....	103
14.3	Cleaning valves.....	104
15	Troubleshooting	105
15.1	Faults without a fault message.....	105
15.2	Faults with error message.....	106
15.2.1	Fault messages on the LCD screen.....	106
15.2.2	Warning messages on the LCD screen.....	108
15.2.3	All other faults.....	109
15.3	Log book.....	109
15.3.1	Fault messages in the log book.....	109
15.3.2	Warning messages in the log book.....	110

15.3.3	Event messages in the log book.....	111
15.3.4	Log book entry - Detailed view.....	111
16	Decommissioning and disposal.....	113
17	Technical data.....	115
17.1	Performance data.....	115
17.1.1	Performance data with vPTFE diaphragm.....	116
17.2	Accuracy.....	117
17.2.1	Standard Liquid End.....	117
17.2.2	Self-Bleeding Liquid End.....	117
17.3	Viscosity.....	118
17.4	Material specifications.....	118
17.5	Electrical data.....	119
17.6	Temperatures.....	119
17.7	Climate.....	120
17.8	Altitude of site	120
17.9	Degree of protection and safety requirements.....	120
17.9.1	Degree of protection.....	120
17.9.2	Safety requirements.....	120
17.9.3	Degree of pollution.....	120
17.10	Compatibility.....	120
17.11	Shipping weight.....	121
17.12	Sound pressure level.....	121
18	Exploded drawings and ordering information.....	122
18.1	Exploded drawings.....	122
18.2	Ordering information.....	146
19	Dimensional drawings.....	147
20	Diagrams for Setting the Capacity.....	156
21	Declaration of Conformity for Machinery.....	159
22	UK Declaration of Conformity	160
23	Approvals.....	161
24	Operating/Set-up overview of the gamma/ X.....	162
25	gamma/ X operating menu, overall.....	164
26	Continuous Displays and Secondary Displays.....	170
27	Installation instructions: Retrofitting Relays	172
28	Index.....	174

1 About this pump

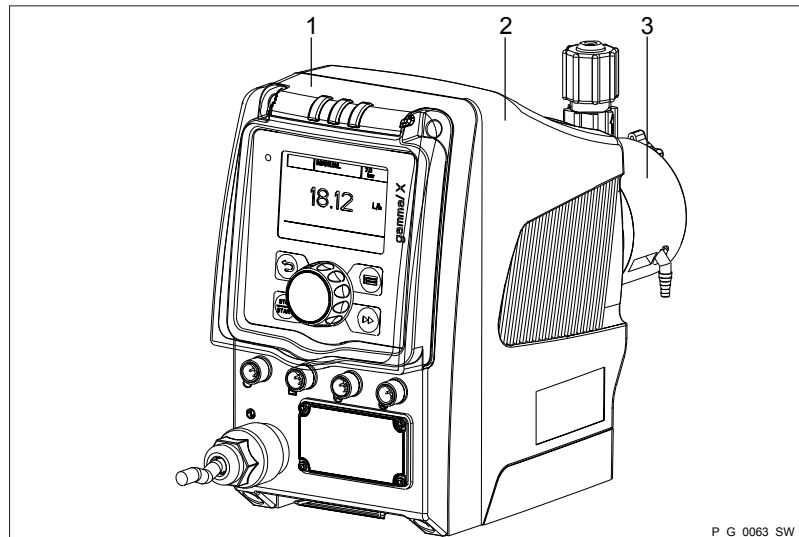

Fig. 2: Overview of equipment, complete

- 1 Control unit
- 2 Drive unit
- 3 Liquid end

The pump is a microprocessor-controlled solenoid metering pump with the following features:

- Adjustment of the metering rate directly in l/h.
- Available material combinations: PP, PVDF, clear acrylic, PTFE and stainless steel.
- Special dosing head designs for outgassing and higher-viscosity media.
- Illuminated LCD screen and 3-LED display for operating, warning and error messages, visible from all sides.
- Factor with external contact control 99:1 ... 1:99.
- Batch operation with max. 99,999 strokes/start pulse.
- Input of the concentration for simple adjustment with volume-proportional metering tasks.
- Stroke rate adjustment in 1 stroke/hour increments from 0 ... 12,000 strokes/h.
- Electronic stroke length adjustment, continuous from 0 ... 100% (recommended 30 ... 100%).
- Connector for 2-stage level switch.
- External control via 0/4 ... 20 mA standard signal with adjustable assignment of signal value to stroke rate.
- Optional 4 ... 20 mA output for remote transmission of stroke length and stroke rate.
- Universal power supply unit 100 ... 230 V, 50/60 Hz.
- Optional 230 V relay module, can also be retrofitted.
- Optional 24 V combined relay, can also be retrofitted.

2 Identity code



Product identification

This identity code serves to identify the product.

Use the identity code from the Product Catalogue for orders.

Product range gamma/ X

GMXa	Type	
	----	Performance data and type - see nameplate
		Dosing head material
		PP Polypropylene
		NP Clear acrylic
		PV PVDF
		TT PTFE + carbon
		SS Stainless steel
		Seal material
		B FPM
		E EPDM
		T PTFE
		F PTFE, FDA-compliant
		Dosing head design
		0 without bleed valve, without valve spring
		1 without bleed valve, with valve spring
		2 with bleed valve, without valve spring
		3 with bleed valve, with valve spring
		4 without bleed valve, with valve spring for higher-viscosity media
		7 self-bleeding with groove (SEK)
		9 self-bleeding with bypass (SEK)
		Hydraulic connector
		0 Standard connection in line with technical data
		5 Connector for 12/6 hose, suction side standard
		9 Connector for 10/4 hose, discharge side only, suction side standard
		Diaphragm rupture indicator
		0 without diaphragm rupture indicator
		1 with diaphragm rupture indicator, optical sensor, electrical signal
		Design
		0 Hous. RAL5003 / Hood RAL2003
		M modified

Product range gamma/ X

Logo

0 with ProMinent logo

Electrical connection

U 100-230 V ± 10%, 50/60 Hz

Cable and plug

A 2 m European

B 2 m Swiss

C 2 m Australian

D 2 m USA / 115 V

E 2 m Great Britain

1 2 m open end

. ...
.

Relay, pre-set to ...

0	no relay	-
1	1 x changeover contact 230 V AC – 6 A	Fault indicating relay (N/C)
4	1 x N/O 24 V DC – 1 A 1 x N/O 24 V DC – 100 mA	as 1 + pacing relay
C	1 x N/O 24 V DC – 100 mA, and 1 x 4-20 mA output	As 1 + 4-20 mA output
F	with automatic bleed valve	230 V AC
G	with automatic bleed valve and relay output	24 V DC

. ...
.

Accessories

0	no accessories
1	with foot and injection valve, 2 m suction line, 5 m metering line
4	Multifunctional valve and accessories

Control version

0	Manual + external contact with pulse control
3	Manual + external contact with pulse control + analogue 0/4-20mA
C	As 3 + CANopen
E	As 3 + PROFINET®
M	As 3 + Modbus RTU
R	As 3 + PROFIBUS® interface, M12

Metering monitor

Product range gamma/ X

																			0	Dynamic metering monitor		
																				Remote stop / Remote control		
																				0	without Bluetooth	
																				B	with Bluetooth	
																					Language	
																				DE	Deutsch	
																				EN	English	
																				ES	Spanish	
																				FR	French	
																				

3 Safety chapter



Cessation of statutory warranty claims

Do not open the unit! We would advise that the unit may only be opened by qualified personnel authorised by ProMinent to avoid damage to the unit and guarantee the seamless and safe operation of the unit. All warranty claims will be invalidated if the unit is opened by unauthorised persons. You forfeit warranty claims and claims for damages against ProMinent for damage caused by unauthorised persons opening the unit.

3.1 Labels

Identification of safety notes

The following signal words are used in these operating instructions to denote different severities of danger:

Signal word	Meaning
WARNING	Denotes a possibly dangerous situation. If this is disregarded, you are in a life-threatening situation and this can result in serious injuries.
CAUTION	Denotes a possibly dangerous situation. If this is disregarded, it could result in slight or minor injuries or material damage.

Warning signs denoting different types of danger

The following warning signs are used in these operating instructions to denote different types of danger:

Warning signs	Type of danger
	Warning – automatic start-up.
	Warning – high-voltage.
	Warning – danger zone.

3.2 Intended use



NOTICE!

Wear caused by "Pump ON/OFF" using the mains connection

Frequent switching of the pump on and off (>2 times each day) using the supply voltage leads to increased wear in the pump. The pump is not technically designed for this.

If necessary, use the "Pause" function to switch the pump to standby mode. Do not switch the pump on and off using the supply voltage to spare a pause input.

- Only use the pump to meter liquid feed chemicals.
- Only use the pump once it has been correctly installed and started up in accordance with the technical data and specifications contained in the operating instructions.
- Observe the general limitations with regard to viscosity limits, chemical resistance and density - see also the ProMinent Resistance List in the Product Catalogue or at www.prominent.com.
- All other uses or modifications are prohibited.
- The pump is not designed to meter gaseous media and solids.
- The pump is not designed to meter flammable media.
- The pump is not designed to meter explosive media.
- The pump is not intended for operation in areas at risk from explosion.
- The pump is not designed for use outdoors without appropriate protective measures.
- Only allow the pump to be operated by trained and authorised personnel, see the following "Qualifications" table.
- You have a duty to observe the information contained in the operating instructions during the different phases of the unit's service life.

3.3 Safety information



WARNING!

Warning about personal and material damage

The pump can start to pump, as soon as it is connected to the mains voltage.

- Install an emergency cut-off switch in the pump power supply line or integrate the pump in the emergency cut-off management of the system.



WARNING!

Warning of personal injury and material damage

The pump can start pumping as soon as it has cooled down after the error '*temperature*'.

- Take this into account with the pump and your installation.



WARNING!

Danger of electric shock

Supply voltage may be present inside the pump housing.

- Safely and quickly disconnect the pump from the mains/power supply if the pump housing has been damaged.
Only return the pump to operation after an authorised repair.



WARNING!

Warning of hazardous feed chemical

Should a dangerous feed chemical be used: it may escape from the hydraulic components when working on the pump, material failure or incorrect handling of the pump.

- Take appropriate protective measures before working on the pump (e.g. safety glasses, safety gloves, ...). Adhere to the material safety data sheet for the feed chemical.
- Drain and flush the liquid end before working on the pump.



WARNING!

Danger from hazardous substances!

Possible consequence: Fatal or very serious injuries.

Please ensure when handling hazardous substances that you have read the latest safety data sheets provided by the manufacture of the hazardous substance. The actions required are described in the safety data sheet. Check the safety data sheet regularly and replace, if necessary, as the hazard potential of a substance can be re-evaluated at any time based on new findings.

The system operator is responsible for ensuring that these safety data sheets are available and that they are kept up to date, as well as for producing an associated hazard assessment for the workstations affected.



CAUTION!

Warning of feed chemical spraying around

Feed chemical may spray out of the hydraulic components if they are tampered with or opened due to pressure in the liquid end and adjacent parts of the system.

- Disconnect the pump from the mains power supply and ensure that it cannot be switched on again by unauthorised persons.
- Ensure that the system is at atmospheric pressure before commencing any work on hydraulic parts of the system.

Warning of feed chemical spraying around

- The metering pump may generate a multiple of its nominal pressure. Hydraulic parts may rupture if a pressure line is blocked.
- Install a relief valve in the pressure line downstream of the metering pump.

**CAUTION!****Warning of feed chemical spraying around**

An unsuitable feed chemical can damage the parts of the pump that come into contact with the chemical.

- Take into account the resistance of the wetted materials and the ProMinent Resistance List when selecting the feed chemical - see the ProMinent Product Catalogue or visit ProMinent.

**CAUTION!****Danger of injury to personnel and material damage**

The use of untested third party components can result in injury to personnel and material damage.

- Only fit parts to metering pumps that have been tested and recommended by ProMinent.

**CAUTION!****Danger from incorrectly operated or inadequately maintained pumps**

Danger can arise from a poorly accessible pump due to incorrect operation and poor maintenance.

- Ensure that the pump is accessible at all times.
- Adhere to the maintenance intervals.

Danger from incorrect dosing

- The metering behaviour of the pump changes if a different liquid end size is fitted.
- Reprogram the pump in the *'Menu / Information → Settings → System → Replace head type'* menu.

**CAUTION!****Warning against illegal operation**

Observe the regulations that apply where the device is installed.

Isolating protective equipment

- Cover of the slot for relays and optional modules - see the chapter entitled "Overview of equipment and control elements"

Customers should only remove the cover of the slot for relays and optional modules and/or a relay or optional module in line with the supplementary instructions for the relays and optional modules.

Customers should only remove the dosing head in accordance with the "Repair" chapter.

Only the ProMinent service department is authorised to open the housing and hood (housing the control elements).

Sound pressure level

Sound pressure level $L_{pA} < 70$ dB according to EN ISO 20361 at maximum stroke length, maximum stroke rate, maximum back pressure (water)

3.4 Information in the event of an emergency

Information in the event of an emergency

In an emergency, either disconnect the mains plug, press  [Start/Stop] or press the Emergency Stop switch installed on the customer's side or disconnect the pump from the mains/power supply in line with the Emergency Stop management guidelines for your system.

If feed chemical escapes, ensure that the pump's hydraulic environment is also at atmospheric pressure. Adhere to the material safety data sheet for the feed chemical.

3.5 Personnel qualification

Qualification of personnel

Task	Qualification
Storage, transport, unpacking	Instructed person
Assembly	Technical personnel, service
Planning the hydraulic installation	Qualified personnel who have a thorough knowledge of metering pumps
Hydraulic installation	Technical personnel, service
Installation, electrical	Electrical technician
Operation	Instructed person
Maintenance, repair	Technical personnel, service
Decommissioning, disposal	Technical personnel, service
Troubleshooting	Technical personnel, electrical technician, instructed person, service

Explanation of the table:

Qualified personnel

A qualified employee is deemed to be a person who is able to assess the tasks assigned to him and recognise possible dangers based on his/her technical training, knowledge and experience, as well as knowledge of pertinent regulations.

Note:

A qualification of equal validity to a technical qualification can also be gained by several years of employment in the relevant field of work.

Electrical technician

An electrical technician is able to complete work on electrical systems and recognise and avoid possible dangers independently based on his/her technical training and experience, as well as knowledge of pertinent standards and regulations.

The electrical technician should be specifically trained for the working environment in which he is employed and know the relevant standards and regulations.

An electrical technician must comply with the provisions of the applicable statutory directives on accident prevention.

Instructed person

An instructed person is deemed to be a person who has been instructed and, if required, trained in the tasks assigned to him/her and possible dangers that could result from improper behaviour, as well as having been instructed in the required protective equipment and protective measures.

Service

The Service department refers to service technicians, who have received proven training and have been authorised by ProMinent to work on the system.

4 Storage, Transport and Unpacking

Safety Information



WARNING!

Only return metering pumps for repair in a cleaned state and with a flushed liquid end - refer to "Decommissioning!"

Only return metering pumps with a completed Decontamination Declaration form. The Decontamination Declaration constitutes an integral part of an inspection / repair order. A unit can only be inspected or repaired when a Declaration of Decontamination Form is submitted that has been completed correctly and in full by an authorised and qualified person on behalf of the pump operator.

The "Decontamination Declaration Form" can be found on our homepage.



CAUTION!

Danger of material damage

The device can be damaged by incorrect or improper storage or transportation!

- The unit should only be stored or transported in a well packaged state - preferably in its original packaging.
- The packaged unit should also only be stored or transported in accordance with the stipulated storage conditions.
- The packaged unit should be protected from moisture and the ingress of chemicals.

Ambient conditions

Ambient conditions - refer to "Technical Data" chapter.

Scope of delivery

Compare the delivery note with the scope of delivery:

- Metering pump with mains cable
- Connector kit for hose/pipe connection (optional)
- Product-specific operating instructions with EC Declaration of Conformity
- Optional accessories

5 Overview of equipment and control elements

5.1 Overview of equipment

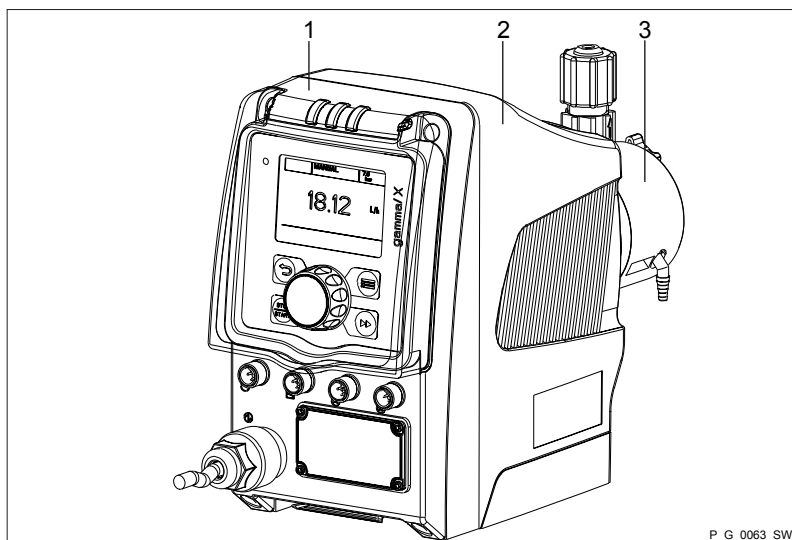

Fig. 3: Overview of equipment, complete

- 1 Control unit
- 2 Drive unit
- 3 Liquid end

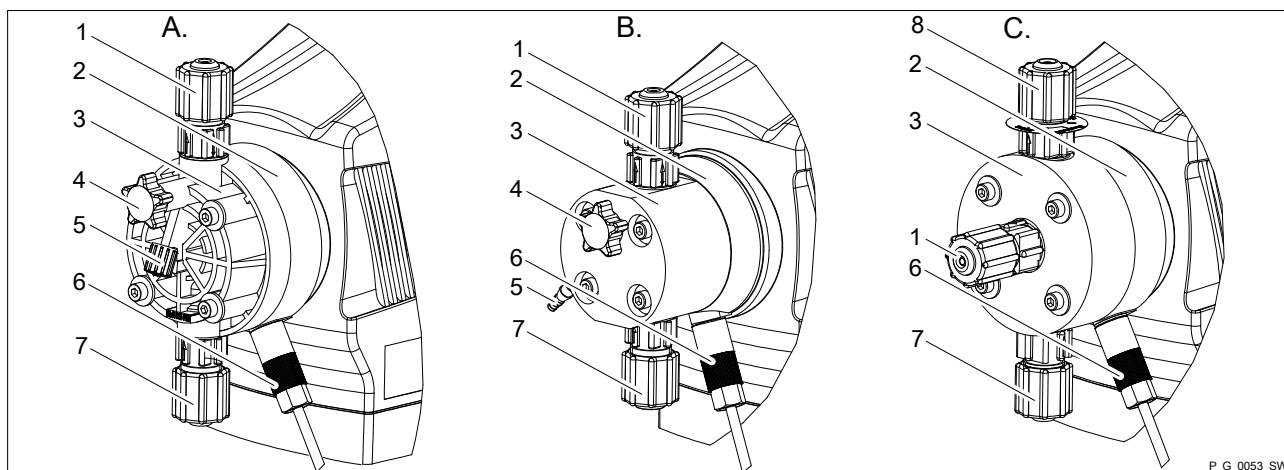

Fig. 4: A. Liquid end with PV bleed valve; B. Liquid end with NP bleed valve; C. Self-bleeding liquid end (SER)

- 1 Discharge valve
- 2 Backplate
- 3 Dosing head
- 4 Bleed valve
- 5 Bypass hose sleeve
- 6 Diaphragm rupture indicator (optional)
- 7 Suction valve
- 8 Bleed valve, self-bleeding



Self-bleeding liquid ends (SER)

Externally self-bleeding liquid ends with groove (SER) look identical to liquid ends with bleed valve.

The SER valve is only approved up to a pressure of 10 bar. We recommend operating a pump with a SER valve of between 1 ... 7 bar.

5.2 Control elements

Control elements, overview

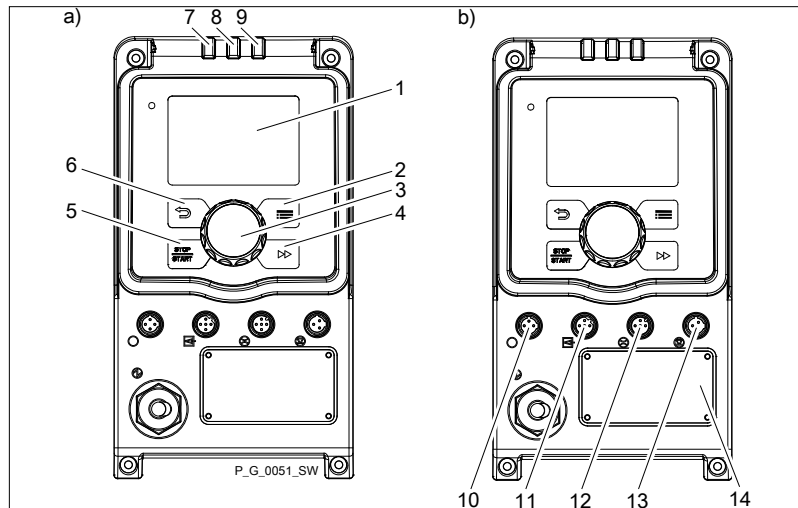







Fig. 5: Control elements

- 1 LCD screen
- 2  [Menu] key
- 3 Clickwheel  
- 4  [Priming] key
- 5  [STOP/START] key
- 6  [Back] key
- 7 Fault indicator (red)
- 8 Warning indicator (yellow)
- 9 Operating indicator (green)
- 10 "Diaphragm rupture indicator" terminal
- 11 "External control" terminal
- 12 "Metering monitor" terminal
- 13 "Level switch" terminal
- 14 Slot for relays and optional modules

5.2.1 Control elements



Use this overview to familiarise yourself with the keys and other control elements on the pump!

Pressure display, identifier and fault displays on the LCD screen

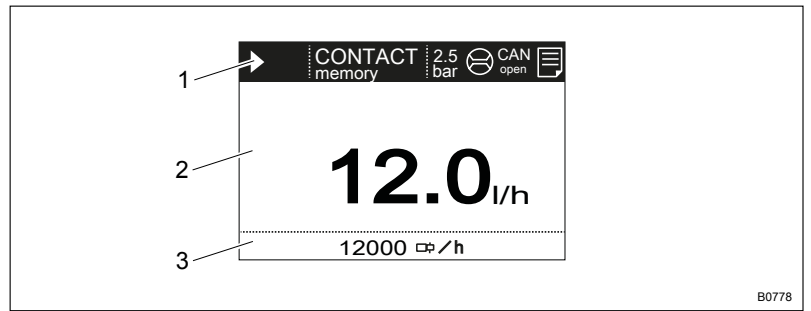

Fig. 6: Construction of the continuous display

- 1 Status bar
- 2 Continuous display, central area
- 3 Secondary display

Refer to the chapter entitled "Main displays and secondary displays" in the Appendix for the different main displays and secondary displays.

The LCD screen supports the operation and adjustment of the pump using different information and various identifiers:

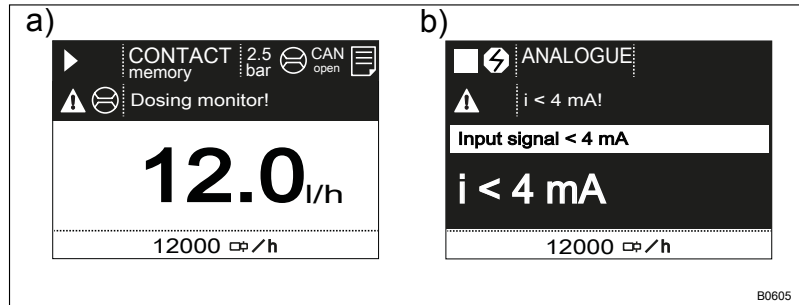

Fig. 7: a) Continuous display with warning message; b) Continuous display with fault message. Explanation of the symbols in the following tables.

The above Figure, Part a) shows that:















- the pump is in operation
- it is in 'Contact' operating mode with "memory" stroke memory
- the average system pressure is 2.5 bar
- a metering monitor is connected
- a CAN module is being used
- a log entry has been made
- a warning message for the 'Dosing monitor' is pending
- the capacity of 12.0 l/h has been set
- the stroke rate is 12,000 strokes / h





Tab. 1: Pressure display

Display	Meaning
	Displays the average system pressure.

Tab. 2: Identifiers and error displays:

Identifier	Meaning
	The pump is working or waiting for a starting signal.
	The pump was manually stopped using the [STOP/START] key.
	The pump was remotely stopped (Pause) - via the "External" socket.

Identifier	Meaning
	The pump was stopped by an error.
	Only with cyclical batch metering: the pump is waiting for the next cycle.
	Only with 'Access protection': the pump software is locked.
'AUX'	The pump is currently pumping at auxiliary capacity and/or auxiliary frequency.
'memory'	Only in 'CONTACT' and 'BATCH' operating modes: The "Stroke memory" auxiliary function has been set.
	The pump is in 'ANALOG' operating mode. The 'Curve → linear' type of processing is set.
	The pump is in 'ANALOG' operating mode. The 'Curve → Upper side band' type of processing is set.
	'Metering → Discharge stroke → optimum' metering profile has been set.
	'Metering → Discharge stroke → fast' metering profile has been set.
	'Metering → Discharge stroke → sine mode' metering profile has been set.
	'Metering → Discharge stroke → continuous' metering profile has been set.
	'Metering → Discharge stroke → DFMa' metering profile has been set.
	'Metering → Discharge stroke → normal' metering profile has been set.
	'Metering → Suction stroke → HV1' metering profile has been set.
	'Metering → Suction stroke → HV2' metering profile has been set.
	'Metering → Suction stroke → HV3' metering profile has been set.

Identifier	Meaning
	A "Flow Control" metering monitor is connected.
	A diaphragm rupture indicator is connected.
	The pump has created a log about the operation.
	The pump is in the 'Menu' (Set up).









Further explanations can be found in the "Troubleshooting" chapter.



The pump only shows the metering volume and the capacity in the calibrated status in l or l/h or in gal or gal/h.

5.2.2 Key functions

Key	Application	In the continuous displays	In the menu
 [Back]	press	-	Go back to the previous menu item (or a continuous display) - without saving
 [STOP/START]	press	Stop pump, Start pump	Stop pump, Start pump
 [Menu]	press	Go to the menu	Go back to a continuous display
 [Priming]	press	Priming *	Priming *
 [Clickwheel]	press	Start batch (only in 'Batch' operating mode), Acknowledge errors	Go to next menu item (or a continuous display) Confirm entry and save
 [Clickwheel]	turn	Switch between the continuous displays	Change figure or change selection



** When priming the pump does not run at maximum stroke rate.*

If  [Priming] is pressed in 'Stop' status, then [Priming] has top priority as long as the button is pressed.



Refer to the "Set-up basics" chapter for information on how to adjust figures

6 Functional description

6.1 Liquid End

The dosing process is performed as follows: The diaphragm is pressed into the dosing head; the pressure in the dosing head closes the suction valve and the feed chemical flows through the discharge valve out of the dosing head. The diaphragm is now drawn out of the dosing head; the discharge valve closes due to the negative pressure in the dosing head and fresh feed chemical flows through the suction valve into the dosing head. One cycle is completed.

6.2 Drive unit

The diaphragm is driven by an electromagnet, controlled by an electronic controller.

Drive technology

The drive technology on the gamma/ X enables the timed progress of the flow to be precisely matched to the requirements of the particular application.

This ensures that users can set the optimum discharge stroke for their application, as required:

Pos.*	Discharge stroke	Application
A.	<i>'optimum'</i>	For maximum precision when metering and the very best results with internal pressure measurement and special functions.
B.	<i>'fast'</i>	For a fast discharge stroke.
C.	<i>'very fast'</i>	For a super-fast discharge stroke.
D.	<i>'sine mode'</i>	The duration of the discharge stroke is dependent on the stroke rate for a long, sine-shaped discharge stroke.
E.	<i>'continuous'</i>	For a continuous discharge stroke e.g. for bottling processes. The duration of the discharge stroke is dependent on the stroke rate.
F.	<i>'DFMa'</i>	For optimum operation with a flow meter DulcoFlow® DFMa.

* see following drawing.

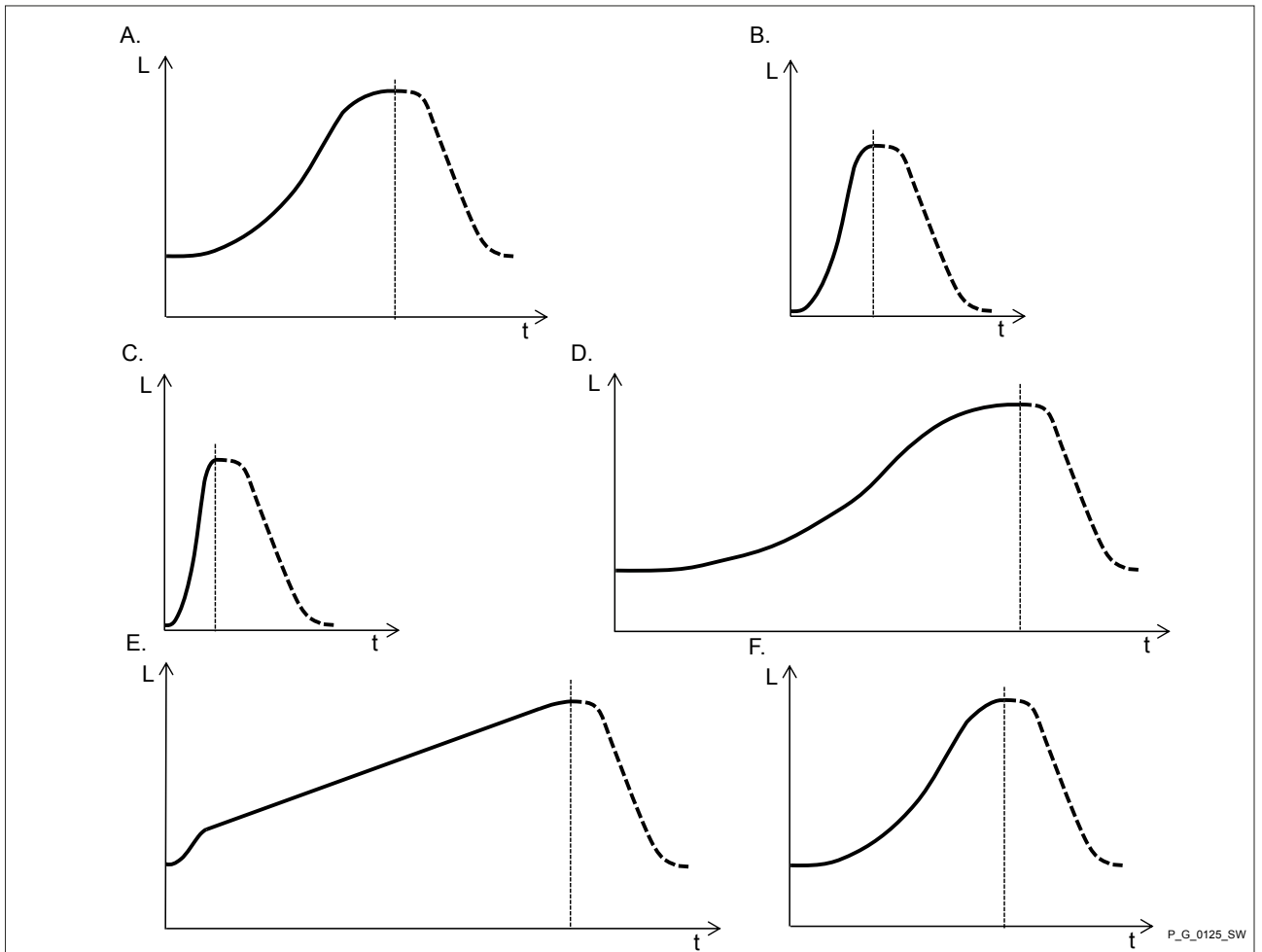

Fig. 8: Discharge stroke metering profiles with stroke L and time t (suction stroke shown as a dotted line)

It is possible to selectively also slow the **suction stroke** with all these metering profiles for the discharge stroke - see . In this way, it is possible to prevent the main cause of inaccurate metering with high viscosity feed chemicals, namely the incomplete filling of the liquid end. With gaseous feed chemicals, the slow suction stroke prevents cavitation and consequently increases dosing precision.

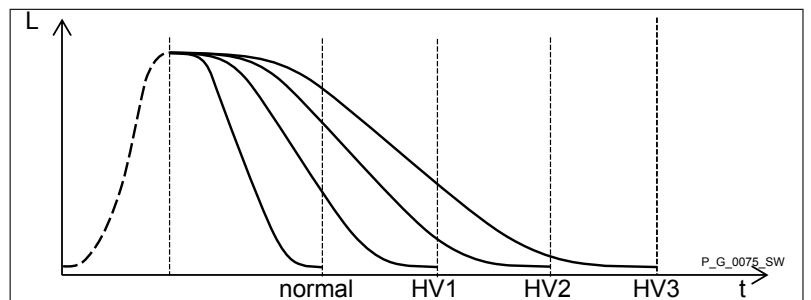

Fig. 9: Suction stroke metering profiles with stroke L and time t

- Normal Normal suction stroke
- HV1 Suction stroke for viscous feed chemical
- HV2 Suction stroke for average viscosity feed chemical
- HV3 Suction stroke for high-viscosity feed chemical

Oscillations in the back pressure in the metering line, which could lead to undesirable variations in the metering volume, are automatically compensated for by the power end/drive. This results in **dosing precision**, which otherwise could only be achieved with complex control circuits.

6.3 Capacity

The capacity set regulates the pump even in *'Automatic'* mode (not with SEK dosing heads).

By contrast, in conventional mode, the stroke length and stroke rate determine the capacity. The stroke length can be adjusted between 0 and 100% via the continuous display or the menu. A metering volume of between 30 to 100% is reproduced as being technically sensible (SEK type: 50 - 100%)! The stroke rate can be set via the menu (not in "Analogue" operating mode) within a range of 0 - 12,000 strokes/h.

6.4 Self-Bleeding

SEK types

Self-bleeding liquid ends without bypass are capable of independent priming when a discharge line is connected and diverting any air pockets present into the discharge line. During operation they are also capable of conveying away gases which are produced, independently of the operating pressure in the system.

SEK types

Self-bleeding liquid ends with ball are capable of independent priming when a discharge line is connected and diverting any air pockets present via a bypass. During operation they are also capable of conveying away gases which are produced, independently of the operating pressure in the system. It is also possible to meter precisely under atmospheric pressure due to the integral back pressure valve.

6.5 Operating modes

The operating modes are selected via the "Operating modes" menu.

Refer to the "Hierarchy of Operating Modes, Functions and Fault Statuses" for the order of the various operating modes, functions and fault statuses.

"Manual" operating mode

'Manual' operating mode permits you to operate the pump manually.

"Contact" operating mode

This operating mode offers the option of activating the pump externally by means of potential-free contacts (e.g. by means of a contact water meter). The "Pulse Control" option enables you to preselect the number of strokes (a scaling or transfer factor of 0.01 to 99.99) in the *'Settings'* menu.

"Batch" operating mode This operating mode provides the option of working with large transfer factors (up to 99,999). Metering can be triggered either by pressing the *[Clickwheel]* or by a pulse received via the "External control" terminal by a contact or a semiconductor switching element. It is possible to pre-select a metering volume (batch) or a number of strokes using the *[Clickwheel]* in the 'Settings' menu.

"Analog" operating mode The capacity and/or stroke rate is controlled by an analogue current signal via the "External control" terminal. Processing of the current signal can be preselected using the control unit.

6.6 Functions

Refer to the "Hierarchy of Operating Modes, Functions and Fault Statuses" for the order of the various operating modes, functions and fault statuses.

The following functions can be selected using the 'Settings' menu:

"Calibrate" function You can also operate the pump in a calibrated state in all operating modes if it is to meter extremely precisely. This can be useful when metering high-viscosity feed chemicals. Calibration is retained over the entire stroke rate range and over a stroke length range of 0 ... 100%.

"Auxiliary capacity" / "Auxiliary frequency" function This facilitates the switch-over to a fixed adjustable capacity / stroke rate in the 'Menu' via the "External control" terminal.

"Degassing" function This permits simple degassing - without the need for an additional vent valve. The pump works at maximum stroke rate based on the selected signal to transport gas bubbles out of the liquid end.

"Timer" function The function permits a simple timer program to be set up without the need for an additional timer module.

The following functions are available as standard:

"Flow" function The function monitors the flow after every single stroke, if a dosing monitor is connected and if 'Fast' is set under 'Settings → Metering → Discharge stroke' or 'DFMa' (for the DulcoFlow). The number of defective strokes, after which the pump is switched off, can be set in the 'Settings' menu.

"Level switch" function Information about the liquid level in the dosing tank is reported to the pump. A two-stage level switch has to be fitted for this purpose, which is connected to the "Level switch" terminal. It is possible to connect a suction lance with continuous level measurement to pumps from 2019 onwards.

"Pause" function The pump can be remotely stopped via the "External control" terminal.

"Stop" function The pump can be stopped without disconnecting it from the mains/ power supply by pressing  [STOP/START].

"Priming" function Priming can be triggered by pressing  [Priming].

6.7 Relays (options)

The pump has several connecting options available:

"Fault indicating relay" option The relay can close a connected power circuit (e.g. for an alarm horn) in the event of warnings or fault messages (e.g. 'Warning level').

The relay can be retrofitted through the slot in the front of the pump – refer to the installation instructions for "Retrofitting relays".

"Fault indicating and pacing relay" option This combined relay can generate a contact with each stroke via its pacing relay in addition to functioning as a fault indicating relay.

The relay can be retrofitted through the slot in the front of the pump.

"Automatic degassing" option The "Automatic degassing" option is used for controlled degassing of the liquid end, if the pump has the "Automatic degassing" option. This option can be retrofitted through the slot in the front of the pump and conversion of the dosing head.

There are two versions:

- Version with 1 relay – to control the electric vent valve in the dosing head (identity code characteristic F, degassing module 3-pin, 230 V)
- Version with 2 relays – one relay to control the electric vent valve in the dosing head and one relay freely available (identity code characteristic G, degassing module 4-pin with relay, 24 V)

"mA-Output" option The current output signal I indicates the pump's actual calculated metering volume. The relay can be retrofitted through the slot in the front of the pump.

The option also always includes a fault indicating relay or a pacing relay.

6.8 LED displays

Fault indicator (red)

LED display	Colour	lit	briefly goes out	flashes
Fault indicator	red	A fault message is pending	-	undefined operating status
Warning indicator	yellow	A warning message is pending	-	-
Operating display	green	The pump is ready for operation	With each stroke	Stroke rate below 30 strokes / min.

6.9 Hierarchy of operating modes, functions and fault statuses

The different operating modes, functions and fault statuses have a different impact on whether and how the pump reacts.

The following list shows the order:

1. - Priming
2. - Stop
3. - Error, Pause
4. - Auxiliary capacity / Auxiliary frequency
5. - Manual, Analog, Contact, Batch, Fieldbus

Comments:

- re 1. - "Priming" can take place in any pump mode (providing it is working).
- re 2. - "Stop" stops everything.
- re 3. - "Error", and "Pause" stop everything apart from "Priming".
- re 4. - "Auxiliary capacity" and/or "Auxiliary frequency" always have priority over the capacity / stroke rate specified by an operating mode listed under 5.

7 Assembly



Please refer to the online version of the operating instructions on our website for the right dimensional drawings for the pump and mounting plate.



Compare the dimensions on the dimensional drawing with those of the pump and/or mounting plate.



CAUTION!

Danger from incorrectly operated or inadequately maintained pumps

Danger can arise from a poorly accessible pump due to incorrect operation and poor maintenance.

- Ensure that the pump is accessible at all times.
- Adhere to the maintenance intervals.



Capacity too low

The liquid end valves can be disturbed by vibrations.

- *Secure the metering pump so that no vibrations can occur.*



Capacity too low

If the valves of the liquid end are not vertical, they cannot close correctly.

- *Ensure that the suction and discharge valves are upright (with self-bleeding liquid ends: the bleed valve).*



Several metering pumps can be arranged closely together as required.

1. ➤ To remove the mounting plate, press down the black flap below the front of the pump a little and press the mounting plate backwards.
2. ➤ Assemble the mounting plate on a **level** and load-bearing base surface (with a minimum of 2 bolts and 2 washers!).
You can also assemble the mounting plate on a **vertical**, level and load-bearing base surface (using 3 bolts and 3 washers!). You then need to rotate the liquid end (vertical valve position!)
You can also assemble the mounting plate on a **wall bracket** (accessories). 3 alignments are possible.
3. ➤ Lock the foot of the metering pump into the mounting plate – see Fig. 10.

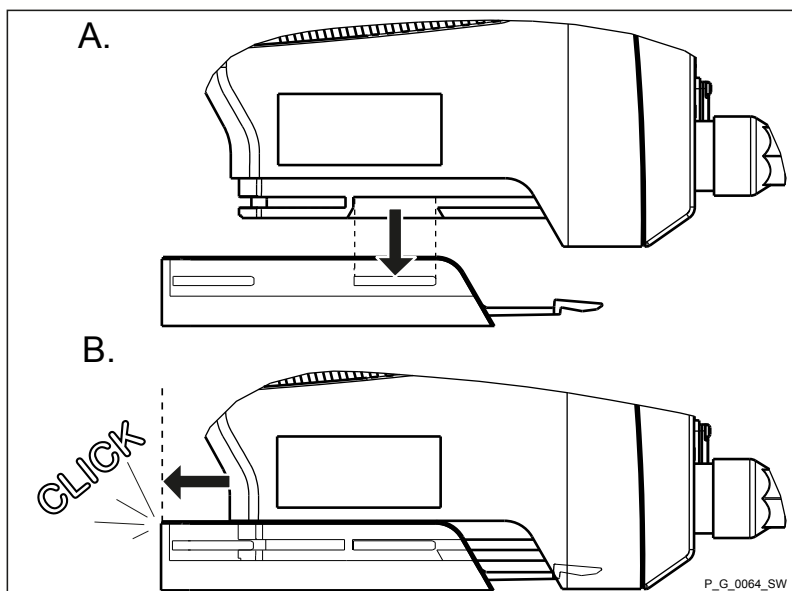





Fig. 10

Tab. 3: Suggested bolts and washers for fixing the assembly foot

Bolt	Type	Size	Washer
	DELTA-PT bolt	50 (WN5412/5452)	A5.3 (DIN 125)
	PT bolt	50 (WN1441/1411 KA/B)	-
	Flat-head bolt	M5 (DIN EN ISO 7045)	A5.3 (DIN 125)
	Allen bolt/	M5 (DIN EN ISO 4762)	A5.3 (DIN 125)

8 Installation, hydraulic

Safety information



CAUTION!

Warning of feed chemical spraying around

An unsuitable feed chemical can damage the parts of the pump that come into contact with the chemical.

- Take into account the resistance of the wetted materials and the ProMinent Resistance List when selecting the feed chemical - see the ProMinent Product Catalogue or visit ProMinent.



CAUTION!

Warning of feed chemical spraying around

Pumps which are not fully installed hydraulically can eject feed chemicals from the outlet openings of the discharge valves as soon as they are connected to the mains.

- The pump must first be hydraulically installed and then electrically.
- In the event that you have failed to do so, press the *[STOP/START]* button or press the emergency-stop switch.



CAUTION!

Warning of feed chemical spraying around

Feed chemical may spray out of the hydraulic components if they are tampered with or opened due to pressure in the liquid end and adjacent parts of the system.

- Disconnect the pump from the mains power supply and ensure that it cannot be switched on again by unauthorised persons.
- Ensure that the system is at atmospheric pressure before commencing any work on hydraulic parts of the system.



CAUTION!

Danger from rupturing hydraulic components

Peak loads during the dosing stroke can cause the maximum permissible operating pressure of the system and pump to be exceeded.

- The discharge lines are to be properly designed.



CAUTION!

Danger of injury to personnel and material damage

The use of untested third party components can result in injury to personnel and material damage.

- Only fit parts to metering pumps that have been tested and recommended by ProMinent.

8.1 Installing hose lines

8.1.1 Installation with metering pumps without degassing

Safety information

**CAUTION!****Warning of feed chemical spraying around**

The pipes can become loose or rupture if they are not installed correctly.

- Route all hose lines so they are free from mechanical stresses and kinks.
- Only use original hoses with the specified hose dimensions and wall thicknesses.
- Only use clamp rings and hose sleeves that are intended for the hose diameter in question to ensure the long service life of the connections.

**CAUTION!****Danger from rupturing hydraulic components**

Hydraulic components can rupture if the maximum permissible operating pressure is exceeded.

- Always adhere to the maximum permissible operating pressure of all hydraulic components - please refer to the product-specific operating instructions and system documentation.
- Never allow the metering pump to run against a closed shut-off device.
- Install a relief valve.

**CAUTION!****Hazardous feed chemicals can escape**

Hazardous or extremely aggressive feed chemicals can escape outside when using conventional degassing procedures with metering pumps.

- Install a degassing line with return line into the supply tank.

**CAUTION!****Hazardous feed chemicals can escape**

Hazardous or extremely aggressive feed chemicals can escape outside in the event that the metering pump is removed from the installation.

- Install a shut-off valve on the discharge and suction side of the metering pump.

**CAUTION!****Uncontrolled flow of feed chemical**

Feed chemical may press through a stopped metering pump if there is back pressure.

- Use an injection valve or a vacuum breaker.



CAUTION!

Uncontrolled flow of feed chemical

The feed chemical can leak through the metering pump in an uncontrolled manner in the event of excessive priming pressure.

- Do not exceed the maximum permissible priming pressure for the metering pump.

INFORMATION: Align the pipes so that the metering pump and the liquid end can simply be removed from the side if necessary.

Installing hose lines - PP, NP, PV, TT designs

1. ➤ Cut off the ends of the hoses at right angles.
2. ➤ Pull the union nut (2) and clamp ring (3) over the hose (1) - see Fig. 11.
3. ➤ Push the hose end (1) up to the stop over the nozzle (4) and widen, if necessary.

INFORMATION: Ensure that the O-ring or the flat seal (5) is sitting properly in the valve (6).

INFORMATION: Never re-use used PTFE seals. An installation sealed in this way is not leak-tight. This type of seal is permanently distorted when subjected to pressure.

INFORMATION: The FPM flat seal PV version has a dot to distinguish it from the EPDM flat seal.

4. ➤ Place the hose (1) with the nozzle (4) onto the valve (6).
5. ➤ Clamp the hose connector: Tighten the union nut (2) while simultaneously pressing on the hose (1).
6. ➤ Re-tighten the hose connector: Pull on the hose line (1) briefly, which is fastened to the dosing head and then re-tighten the union nut (2).

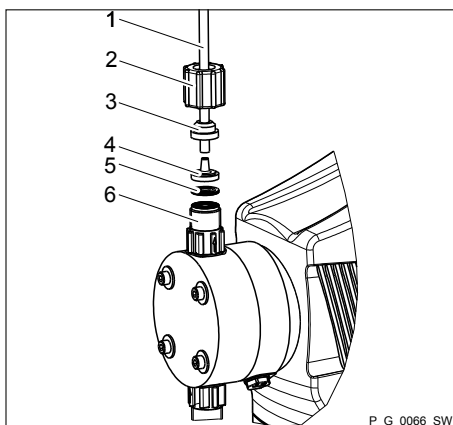

- 1 Hose
- 2 Union nut
- 3 Clamp ring
- 4 Nozzle
- 5 O-ring or flat seal
- 6 Valve

Fig. 11: PP, NP, PV and TT designs

Installing stainless steel pipe - SS designs

1. ➤ Push the union nut (2) and clamp rings (3, 4) over the pipe (1) with approx. 10 mm overhang - see Fig. 12.
2. ➤ Insert the pipe (1) up to the stop in the valve (5) and then withdraw 1...2 mm.

3. ➤ Tighten the union nut (2).

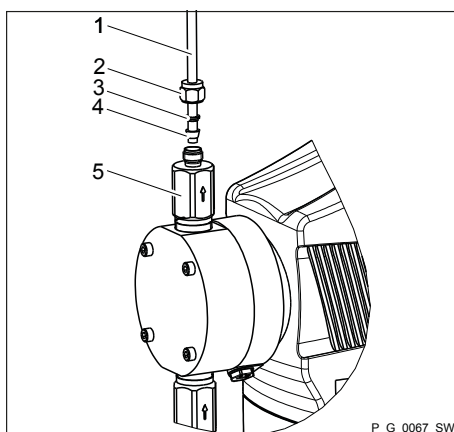

- 1 Pipe
- 2 Union nut
- 3 Rear clamp ring
- 4 Front clamp ring
- 5 Valve

Fig. 12: SS designs with pipe

Installing hose lines - SS version



CAUTION!

Warning of feed chemical spraying around

Connections can come loose in the event that hose lines are installed incorrectly on stainless steel valves.

- Only use PE or PTFE hose lines.
- In addition, insert a stainless steel support insert into the hose line.

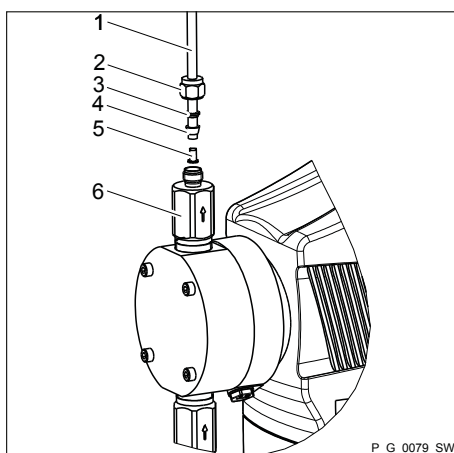

- 1 Hose
- 2 Union nut
- 3 Rear clamp ring
- 4 Front clamp ring
- 5 Support insert
- 6 Valve

Fig. 13: SS version with hose

8.1.2 Installation with metering pumps with degassing

Safety information

Installation of the return line

INFORMATION: All the installation and safety information for metering pumps without degassing also applies.

A return line is also connected in addition to the suction and pressure line.

1. ➤ Attach the hose line to the return hose sleeve or to the liquid end vent valve. PVC hose, soft, 6x4 mm is recommended.
2. ➤ Feed the free end of the return line into the supply tank.
3. ➤ Shorten the return line so that it is not immersed in the feed chemical in the supply tank.

8.1.3 Installation with metering pumps with self-degassing (SEK type)

Safety information



CAUTION!

- All the installation and safety information for metering pumps without self-degassing also apply.
- Do not exceed the maximum values for priming lift, priming pressure and viscosity of the feed chemical.
- Do not allow the suction side line cross-section to exceed the line cross-section on the suction valve.

Information about priming pressure

- Make sure that the pressure in the return line is at least equal to the priming pressure on the suction side.
- Back pressure in the return line restricts the degassing function.
- In contrast, it is possible to operate the pump with back pressure in the return line and atmospheric pressure on the suction side.

Installation of the return line

A return line is also connected in addition to the suction and pressure line.

- The return line is connected to the vertical valve on the upper side of the liquid end. It is factory-labelled with a red sleeve - see Fig. 11.
 - The pressure line is connected to the horizontal valve.
1. Attach the hose line to the return hose sleeve or to the liquid end vent valve. PVC hose, soft, 6x4 mm is recommended.
 2. Feed the free end of the return line into the supply tank.
 3. SEK only: Insert the return line into the anti-kink device on the vent valve and pull it downwards until the anti-kink device engages.

INFORMATION: The anti-kink device prevents the return line from kinking, avoiding the risk of self-degassing failure.

4. Shorten the return line so that it is not immersed in the feed chemical in the supply tank.

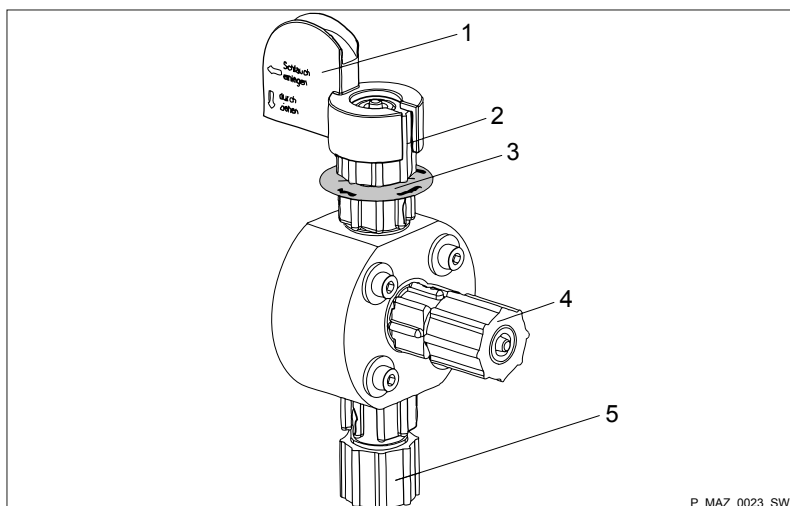

Fig. 14: SEK liquid end

- 1 Anti-kink device
- 2 Vent valve for the return line into the supply tank, 6/4 mm
- 3 Red sleeve
- 4 Discharge valve for the pressure line to the injection point, 6/4 - 12/9 mm
- 5 Suction valve for the suction line in the supply tank, 6/4 - 12/9 mm

8.2 Basic installation notes

Safety notes



CAUTION!

Danger resulting from rupturing hydraulic components

Hydraulic components can rupture if the maximum permissible operating pressure is exceeded.

- Never allow the metering pump to run against a closed shut-off device.
- With metering pumps without integral relief valve: Install a relief valve in the discharge line.



CAUTION!

Hazardous feed chemicals can escape

With hazardous feed chemicals: Hazardous feed chemical can leak out when using conventional bleeding procedures with metering pumps.

- Install a bleed line with a return into the storage tank.

➔ Shorten the return line so that it does not dip into the feed chemical in the storage tank.

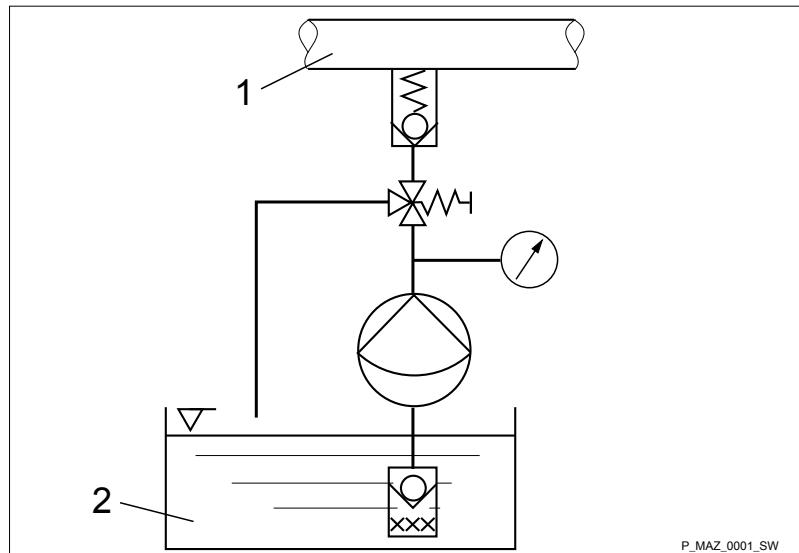

Fig. 15: Standard installation

- 1 Main line
- 2 Storage tank

Legend for hydraulic diagram

Symbol	Explanation	Symbol	Explanation
	Metering pump		Foot valve with filter meshes
	Injection valve		Level switch
	Multifunctional valve		Manometer

9 Installation, electrical

**WARNING!****Danger of electric shock**

A mains voltage may exist inside the device.

- Before any work, disconnect the device's mains cable from the mains.

**WARNING!****Risk of electric shock**

In the event of an electrical accident, the pump must be quickly disconnected from the mains.

- Install an emergency cut-off switch in the pump power supply line or
- Integrate the pump in the emergency cut-off management of the system and inform personnel of the isolating option.

**WARNING!****Danger of electric shock**

Incompletely installed electrical options can allow moisture into the inside of the housing.

- Fit appropriate modules into the slot on the front of the pump or use the original blank cover to seal it in a leak-tight manner.

**WARNING!****Danger of electric shock**

Supply voltage may be present inside the pump housing.

- Safely and quickly disconnect the pump from the mains/power supply if the pump housing has been damaged.
Only return the pump to operation after an authorised repair.

**CAUTION!****Risk of short circuiting caused by moist pins**

No moisture must reach the pins of the PROFIBUS® jack.

- A suitable PROFIBUS® plug or protective cap must be screwed onto the PROFIBUS® jack.



CAUTION!

Material damage possible due to power surges

Should the pump be connected to the mains power supply in parallel to inductive consumers (such as solenoid valves, motors), inductive power surges can damage the control when it is switched off.

- Provide the pump with its own contacts (Phase) and supply with voltage via a contactor relay or relay.
- Should this not be possible, then switch a varistor (part no. 710912) or an RC gate (0.22 μ F/220 Ω , part no. 710802) in parallel.



CAUTION!

Bonding of the contacts of your switching relay

The high starting current can cause the contacts of the on-site switching relay to bond together if the mains voltage switches a solenoid metering pump on and off in a process.

- Use the switching options offered by the external socket to control the pump (functions: Pause, Auxiliary frequency or Operating modes: Contact, Batch, Analogue).
- Use a starting current limiter if it is impossible to avoid switching the pump on and off via a relay.

→ Install the pump in line with best working practice and in accordance with the operating instructions and applicable regulations.

9.1 Supply voltage connector - power supply



WARNING!

Unexpected start-up is possible

The pump can start pumping and consequently feed chemical may escape as soon as the pump is connected to the mains/power supply.

- Avoid the escape of feed chemical.
- If you have not done so, immediately press *[STOP/START]* or disconnect the pump from the mains voltage e.g. using an Emergency Stop switch.
- Refer to the material safety data sheet for your feed chemical.



CAUTION!

If the pump is integrated into a system: Design the system so that potential hazardous situations are avoided by pumps starting up automatically subsequent to unintended power interruptions.

Connect the pump to the power supply using the mains cable.

9.2 HMI operating unit

Connect the HMI to the CAN socket above the LEDs of the pump base if the pump is operated with HMI.

If the pump is operated without HMI, then plug the sealing cap supplied into the CAN socket above the LEDs of the pump base.

**CAUTION!****Risk of short circuiting**

A short circuit may occur in the pump if liquid penetrates into the CAN socket.

- Always plug a CAN plug or the sealing cap supplied into the CAN socket.

**CAUTION!****Danger of malfunction**

Incorrect operation via the CAN bus will lead to malfunctions.

- Do not connect any other control (e.g. DXCa) to the CAN socket when operating with HMI connected.

9.3 Description of the terminals

9.3.1 "External control" terminal

The "External control" terminal is a 5-pin panel terminal. It is compatible with 2- and 4-pin cables.

Only use a 5-pin cable with the "Auxiliary capacity" / "Auxiliary frequency" functions.

Only use a 4-pin or a 5-pin cable with the "mA input" function.

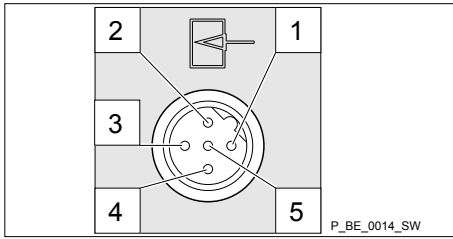

Fig. 16: Assignment on the pump

Electrical interface for pin 1 "Pause" - pin 2 "External contact" - pin 5 "Auxiliary capacity / Auxiliary frequency"

Data	Value	Unit
Voltage with open contacts	5	V
Input resistance	10	kΩ
Max. pulse frequency	25	pulse/s
Min. pulse duration	20	ms

Control via:

- potential-free contact (load: 0.5 mA at 5 V) or
- semiconductor switch (residual voltage < 0.7 V)

Electrical interface for pin 3 "mA input" (with identity code characteristic "Control version": 2 and 3)¹

Data	Value	Unit
Input load, approx.	120	Ω

¹ At 0.0 .. 0.4 mA (4.4 mA) the metering pump performs its first metering stroke and at 19.6 ... 20.0 mA the pump reaches maximum frequency.

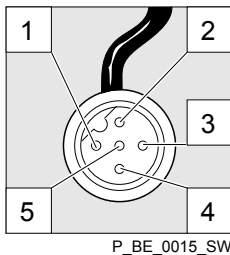

Fig. 17: Assignment on the cable

Pin	Function	5-wire cable	2-wire cable
1	Pause	brown	bridged at pin 4
2	External contact	white	brown
3	mA input*	blue	-
4	Earth GND	black	white
5	Auxiliary capacity / Auxiliary frequency	grey	-

* with identity code characteristic "Control version": 3



Refer to the functional description for the sequence of functions and operating modes.

"Pause" function

The pump works if:

- pin 1 and pin 4 are connected to each other and the cable is connected.
- no cable is connected.

The pump does not work if:

- pin 1 and pin 4 are open and the cable is connected.



Acknowledge fault with 'Pause'

Certain errors requiring acknowledgement can also be acknowledged using 'Pause' instead of using the [P] key. These are errors like: 'Flow', 'Air lock', 'p-' (as soon as the conditions are in order).

"External contact" operating mode

The pump performs one or more strokes if:

- Pin 2 and pin 4 are connected to each other for at least 20 ms. At the same time, pin 1 and pin 4 must also be connected to each other.

"Analog" operating mode

The pump capacity and/or stroke rate can be controlled by a current signal. The current signal is connected between pin 3 and pin 4.

Pin 1 and pin 4 must also be connected.

"Auxiliary capacity" / "Auxiliary frequency" operating mode

The pump works at a pre-set capacity / stroke rate if:

- Pin 5 and pin 4 are connected to each other. At the same time, pin 1 and pin 4 must also be connected to each other. The auxiliary capacity / auxiliary frequency is factory-preset to maximum capacity / stroke rate.

9.3.2 "Level switch" terminal

There is a connecting option for a 2-stage level switch with pre-warning and limit stop or a suction lance with continuous level measurement.

9.3.2.1 Suction lance with 2-stage level switch

Electrical interface

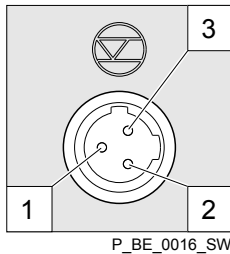

Fig. 18: Assignment on the pump

Data	Value	Unit
Voltage with open contacts	5	V
Input resistance	10	kΩ

Control via:

- potential-free contact (load: 0.5 mA at 5 V) or
- semiconductor switch (residual voltage < 0.7 V)

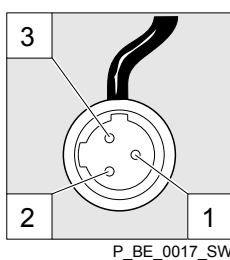

Fig. 19: Assignment on the cable

Pin	Function	3-wire cable
1	Earth GND	black
2	Minimum pre-warning	blue
3	Minimum limit stop	brown

9.3.3 "Metering monitor" terminal

There is a connecting option for a metering monitor.

Electrical interface

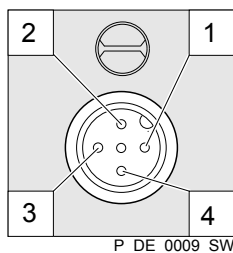

Fig. 20: Assignment on the pump

Data	Value	Unit
Voltage with open contacts	5	V
Input resistance	10	kΩ

Control via:

- potential-free contact (load: 0.5 mA at 5 V) or

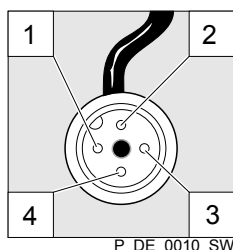

Fig. 21: Assignment on the cable

Pin	Function	4-wire cable
1	Power supply (5 V)	brown
2	Coding	white
3	Feedback	blue
4	Earth GND	black

9.3.4 "Diaphragm rupture indicator" terminal

There is a connecting options for a diaphragm rupture indicator.

Electrical interface

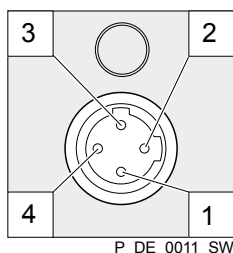

Fig. 22: Assignment on the pump

Specification	Value
Supply voltage, approx.:	+5 V, can be loaded to 20 mA (current limitation 150 mA)
Power consumption:	min. 10 mA, max. 20 mA (sensor presence detection)
Sensor signal:	potential-free contact (load: 0.5 mA at +5 V) or semiconductor switch (residual voltage < 0.3 V)

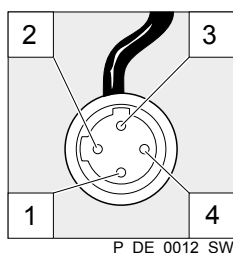

Fig. 23: Assignment on the cable

Pin	Function	4-wire cable
1	Power supply (5 V)	brown
2	not assigned	white
3	Sensor signal	blue
4	Earth GND	black

9.3.5 Relays

9.3.5.1 Relay functions

Tab. 4: *gamma/ X GMXa*

Identity code	Designation	Type	Maximum voltage	Maximum current	Operational lifetime Min. switching operations
0	no relay	-	-	-	-
1	Fault indicating relay, N/C	Changeover contact	230 V AC	6 A	50 000
4	Fault indicating relay, N/C	N/C	24 V DC	1 A	50 000
	Pacing relay, normally open	N/O	24 V DC	100 mA	unlimited
C	4-20 mA current output	-	-	-	-
	Fault indicating relay, N/C	N/C	24 V DC	100 mA	unlimited
F	Automatic bleeding	Changeover contact	230 V AC	6 A	50 000
G	Automatic bleeding	N/O	24 V DC	1 A	50 000
	Fault indicating relay, N/C	N/C	24 V DC	100 mA	unlimited

Relay type

You can reprogram the relays to these types:

Menu setting	Effect
Timer	The relay switches when requested by the timer.
Fault	The relay switches in the event of an error message (red LED*).
Warning	The relay switches in the event of a warning message (yellow LED*).
Warning + error (fault indicating relay)	The relay switches in the event of a warning message (yellow LED*) or an error message (red LED*).
Warning + error + stop	The relay switches in the event of a warning message (yellow LED*), when stopped by <i>[Start/Stop]</i> or in the event of a fault message (red LED*).
Pump active	The relay switches as soon as the pump is in standby and not stopped and not in a state like <i>'Pause'</i> or if an error is pending. In the opposite case, the relay switches back again.
Stroke rate** (pacing relay)	The relay switches with every stroke.
Cycle quantity** (pacing relay)	The relay always switches when the set cycle quantity has been reached.
Metering / Batch	The relay changes its state as soon as a batch has been processed.
Degassing***	The relay opens an optionally installed bleed valve as soon as the control activates it.

* see the "Troubleshooting" chapter

** only use 'Relay 2' for this relay type (semiconductor relay).

*** only use 'Relay 1' for this relay type.

Relay polarity

You can set here how a relay is to switch.

Menu setting	Effect
Break contact N/C	The relay is closed in normal mode and opens with a triggering event. (N/C)
Make contact N/O	The relay is open in normal mode and closes with a triggering event. (N/O)

9.3.5.2 "Fault indicating relay" output (identity code 1)

A fault indicating relay can be ordered as an option - refer to ordering information in the appendix. It is used to emit a signal when there is a fault with the pump and for the "Liquid level low, 1st stage" warning message and "Liquid level low 2nd stage" fault message.

The fault indicating relay can be retrofitted and is operational once attached to the relay board - refer to "Retrofitting relays" supplementary operating instructions.

The behaviour is factory-programmed. If another switching function is wished, the pump can be reprogrammed in the 'Relay' menu.

The relay can be retrofitted and is operational once it has been plugged into the relay board.

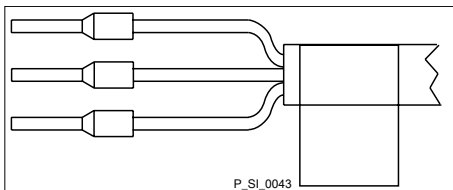

Fig. 24: Assignment on the cable

Identity code 1

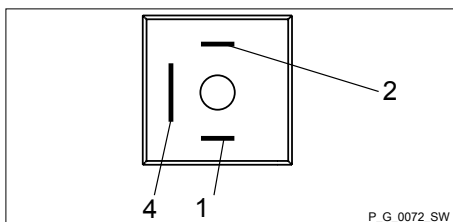

Fig. 25: Assignment on the pump

To pin	VDE cable	Contact	CSA cable
1	white	N/O (normally open)	white
2	Green	N/C (normally closed)	red
4	brown	C (common)	black

9.3.5.3 Output for other relays (identity code 4)

A fault indicating and a pacing relay can be ordered as options - refer to ordering information in the appendix. The pacing output is electrically isolated by means of an optocoupler with a semiconductor switch. The second switch is a relay (also electrically isolated).

The behaviour is factory-programmed. If another switching function is wished, the pump can be reprogrammed in the 'Relay' menu.

The fault indicating/pacing relay can be retrofitted and is operational once attached to the relay board - refer to the "Retrofitting relays" supplementary instructions.

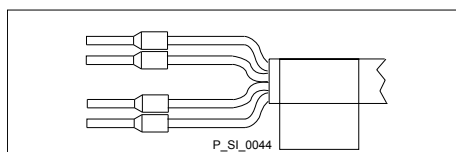

Fig. 26: Assignment on the cable

Electrical interface

for semiconductor switch pacing relay:

Data	Value	Unit
Max. residual voltage at $I_{off\ max} = 1\ \mu A$	0.4	V
Pacing pulse duration, approx.	100	ms

Identity code 4

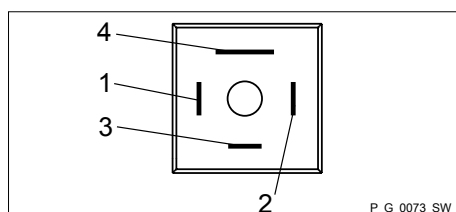

Fig. 27: Assignment on the pump

To pin	VDE cable	Contact	Relay
1	yellow	N/O (normally open)	Relay 1
4	Green	C (common)	Relay 1
3	white	N/O (normally open)	Relay 2
2	brown	C (common)	Relay 2

9.3.5.4 "Current output plus relay" output (identity code C)

A relay combined with a current output can be ordered as an option. The relay either switches as a fault indicating relay in the event of a fault on the pump and with "Liquid level low 1st stage" warning message and "Liquid level low 2nd stage" fault messages or is used as a pacing relay.

The behaviour is factory-programmed. If another switching function is wished, the pump can be reprogrammed in the 'Relay' menu.

The variable to be signalled for the current output can be selected in the 'ANALOGUE OUTPUT' menu.

The current output plus relay can be retrofitted and operates once it is plugged into the board.

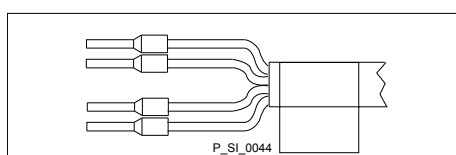

Fig. 28: Assignment on the cable

Electrical interface

for current output

Data	Value	Unit
Open circuit voltage:	8	V
Current range:	4 ... 20	mA
Ripple, max.:	80	μA ss
Load, max.:	250	Ω

for semiconductor switch ("relay"):

Data	Value	Unit
Max. residual voltage at $I_{off\ max} = 1\ \mu A$	0.4	V
Pacing pulse duration, approx.	100	ms

Identity code c

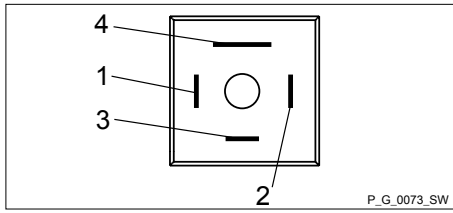

Fig. 29: Assignment on the pump

To pin	VDE cable	Contact	Relay
1	yellow	"+"	Current output
4	Green	"-"	Current output
3	white	N/C (normally closed) or N/O (normally open)	Relay
2	brown	C (common)	Relay

10 Basic set-up principles



- Please also refer to all the overviews covering "Operating/set-up overview" and "Operating menu for gamma/ X, complete" in the appendix and the "Overview of equipment and control elements" and "Control elements" chapters.
- The pump exits the menu and returns to a continuous display if [Menu] is pressed or no key is pressed for 60 seconds.

10.1 Basic principles for setting up the control



Fig. 30: Please read

Fig. 31 shows using the "Language" example how to set up something - in turn:

- Sequence of displays
- The path derived from this
- The path as presented in the operating instructions

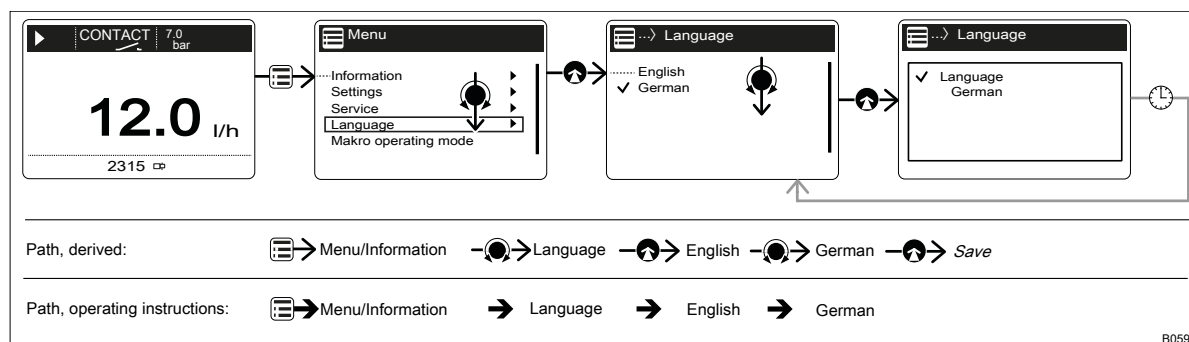



Fig. 31: "Setting up the language": As an example of set-up and path displays

Tab. 5: Legend:

Symbol	Explanation
	Press [Menu]
	Turn the [Clickwheel]
	Press the [Clickwheel]

"Setting up the language" in detail

1. To access the 'Menu': press the [Menu] key.
⇒ The cursor immediately points to 'Information'.
2. To switch from 'Information' to 'Language': turn the [Clickwheel].
3. To return to the 'Language' menu: press the [Clickwheel].
⇒ The cursor points to a language.
4. To switch to 'Deutsch': turn the [Clickwheel].
5. To save: press the [Clickwheel].
⇒ The software shows a display by way of confirmation.
After 2 seconds, it returns to the higher-level 'Menu'.

6. ➔ To complete the setting: press  [Menu].
Alternatively: wait 60 seconds or exit the 'Menu' via the  [Menu] key or using 'End'.

Confirming an entry

- ➔ Briefly press the [Clickwheel].
⇒ The software switches to the next menu point or back to the menu and saves the entry.

Exiting a menu option without confirming it

- ➔ Press  [Back].
⇒ The software switches to the next menu point or back to the menu without saving anything.

Returning to a continuous display

- ➔ Press  [Menu].
⇒ The software cancels the entry and switches to a continuous display without saving anything.

Changing adjustable variables

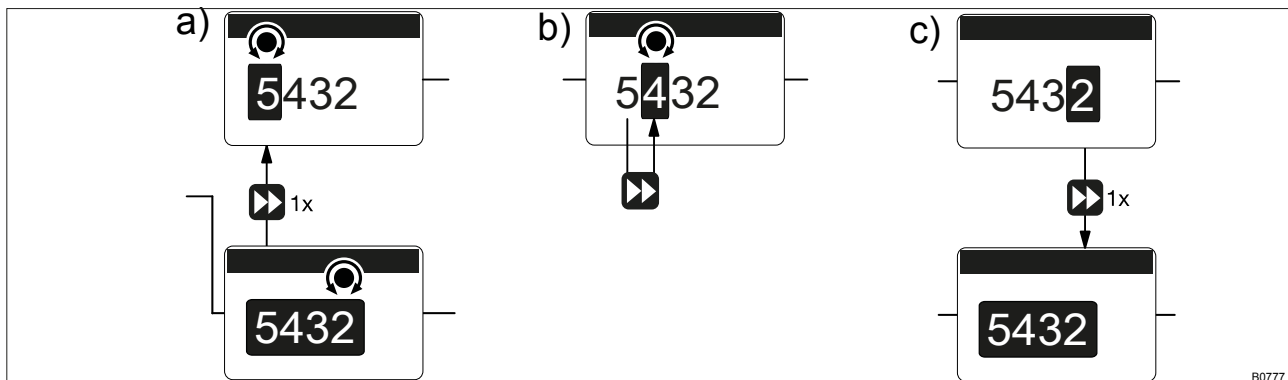





Fig. 32: a) Changing from one figure to its initial figures; b) Changing the figure; c) Returning from the last figure to the (complete) figure (to correct a wrong figure, for example).

Changing a (complete) number

- ➔ Turn the [Clickwheel].
⇒ The value of the figure highlighted is raised or lowered.

Changing figures

- ➔ To adjust the value of a figure digit-by-digit, press  [Priming].
⇒ The first figure is highlighted - see Figure above, point a)
- ➔ To adjust the value of a figure, turn the [Clickwheel].
- ➔ To move to the next figure, press  [Priming] - see above Figure, point b).

4. ➔ To run through the figures again, if necessary (possibly because of an incorrect figure), when you get to the last figure press  [Priming] again - see above Figure, point c).
 - ⇒ Now you can start from the beginning again.

Confirming adjustable variables

- ➔ Press the [Clickwheel] 1x.
 - ⇒ The software saves the entry.

10.2 Checking adjustable variables

Continuous displays

Before adjusting the pump, you can check the current settings of the adjustable variables:

- ➔ Simply turn the [Clickwheel] if the pump is showing a continuous display.
 - ⇒ Each time the [Clickwheel] engages when you turn it, you will see a different continuous display.



The number of continuous displays depends on the identity code, the selected operating mode and the connected additional devices – see overview of "Continuous displays" in the appendix.

Secondary displays

The lowest line of a continuous display shows different information (which cannot be adjusted in the secondary display) - see "Continuous displays and secondary displays" overview in the appendix.

You can access secondary displays via any continuous display as follows:

1. ➔ Press the [Clickwheel] for 3 seconds.
 - ⇒ A frame appears around the secondary display.
2. ➔ Providing there is a frame, you will see a different secondary display each time the [Clickwheel] engages when turned.
 - When you reach the secondary display you wish, leave the [Clickwheel] and wait briefly.

10.3 Changing to Setting mode

In a continuous display, if you press  'Menu', the pump in Setting mode changes to 'Menu'. For more information refer to the following chapter entitled "Set up / Menu".

If under 'Access protect.' only 'Menu' or 'All' has been set up (top right  lock symbol), then after pressing the [Clickwheel], first enter the 'Password'.

11 Set up / 'Menu'



- Refer to the overviews covering "Operating/set up overview" and "Operating menu gamma/ X, complete" in the appendix and in the "Overview of equipment" - "Control elements" chapters by way of supplementary information.
- The pump exits the menu and returns to a continuous display if  [Menu] is pressed or if no key is pressed for 60 seconds.

The 'Menu' is sub-divided as follows:

- 1 - 'Information'
- 2 - 'Settings'
- 3 - 'Timer'
- 4 - 'Service'
- 5 - 'Language'

11.1 'Information'

 → 'Menu / Information → ...'

The 'Information' provides information on your pump and certain parameters and counters. The number and type can depend on the pump settings.

11.2 'Settings'

 → 'Menu / Information → Settings → ...'

The 'Settings' menu generally includes these setting menus:

- 1 - 'Operating mode'
- 2 - 'Automatic'
- 3 - 'Stroke length'
- 4 - 'Metering'
- 5 - 'Concentration'
- 6 - 'Calibrate'
- 7 - 'System'
- 8 - 'Inputs/outputs'
- 9 - 'Config I/O'
- 10 - 'Degassing'
- 11 - 'Priming time'
- 12 - 'Set time'
- 13 - 'Date'

11.2.1 'Operating mode'

 → 'Menu / Information → Settings → Operating mode → ...'

11.2.1.1 'Manual'

 → 'Menu / Information → Settings → Operating mode → Manual'

'Manual' operating mode lets you operate the pump manually.

The capacity and/or stroke rate and stroke length can be set in the continuous displays in this operating mode.

11.2.1.2 'Contact'

 → 'Menu / Information → Settings → Operating mode → Contact → ...'

'Contact' operating mode allows you to trigger individual strokes or a series of strokes.

You can trigger the strokes via a pulse sent via the "External control" terminal.

The purpose of this operating mode is to convert the incoming pulses into strokes with a step-down (fractions) or small step-up or also 1:1.



CAUTION!

The pump maintains the stroke rate when changing over from 'Manual' operating mode to 'Contact' operating mode.



The maximum stroke rate can be set in 'Contact' operating mode. It should normally be set to 12,000 strokes/hour.

Contact - adaptive

If the gaps between the pulses (e.g. from a contact water meter) slowly change, you can set the pump to 'Adaptive → On' - the pump will then meter more evenly.

Memory - Pulses not yet processed

You can also activate the 'Memory' function extension ("memory" identifier). When 'Memory' is activated, the pump adds up the remaining strokes, which could not be processed, up to the maximum capacity of the stroke memory of 999,999 strokes. If this maximum capacity is exceeded, the pump goes into fault mode.



CAUTION!

- Only with 'Memory' - 'off': If you press  [STOP/START] or empty the contact memory ('Menu / Information → Service → Clear counters') or the "Pause" function is activated, the 'Memory' is cleared.

('Automatic' 'Off') factor

The number of strokes per pulse depends on the factor which you can input. By using a factor you can multiply incoming pulses by a factor between 1.01 to 99.99 or reduce them by a factor of 0.01 to 0.99:

$$\text{Number of strokes executed} = \text{factor} \times \text{number of incoming pulses}$$

Table of examples

	Factor	Pulse (sequence)	Number of strokes (sequence)
Step-up*			
	1	1	1
	2	1	2
	25	1	25
	99.99	1	99.99
	1.50	1	1.50 (1 / 2)
	1.25	1	1.25 (1 / 1 / 1 / 2)
Step-down**			
	1	1	1
	0.50	2	1
	0.10	10	1
	0.01	100	1
	0.25	4	1
	0.40	2.5 (3 / 2)	(1 / 1)
	0.75	1.33 (2 / 1 / 1)	(1 / 1 / 1)

Tab. 6: * Explanation of step-up

With a factor of 1	... 1 stroke is executed per 1 pulse
With a factor of 2	... 2 strokes are executed per 1 pulse
With a factor of 25	... 25 strokes are executed per 1 pulse

Tab. 7: ** Explanation of step-down

With a factor of 1	... 1 stroke is executed per 1 pulse.
With a factor of 0.5	...1 stroke is executed after 2 pulses.
With a factor of 0.1	...1 stroke is executed after 10 pulses.
With a factor of 0.75	...1 stroke is executed once after 2 pulses, then 1 stroke is executed twice after 1 pulse, and then again 1 stroke after 2 pulses etc.



If a remainder is obtained when dividing by the factor, then the unit adds the remainders together. As soon as this sum reaches or exceeds "1", the pump executes an additional stroke. Therefore on average during the metering operation, the resultant number of strokes precisely matches the factor.

Metering volume ('Automatic' 'On')

The same applies to the 'Metering volume' as to the 'Factor'.

Contact water meter

Using "Pulse control" you can ideally adapt the pump to the relevant process, for example in conjunction with contact water meters.

11.2.1.3 'Batch'



'Menu / Information → Settings → Operating mode → Batch → ...'

The 'Batch' operating mode enables you to pre-select large metering volumes.

You can only select whole numbers but no fractions as the number of strokes (figures 1 to 99,999).

You can trigger the strokes using the [Clickwheel] if you have already switched to the 'Push' continuous display. You can also trigger them via a pulse using the "External control" terminal.



The stroke rate can be set in 'Batch' operating mode. It should normally be set to 12,000 strokes/hour.



The maximum batch time that can be set is 10 000 s.



The maximum possible batch in automatic mode is the feed rate (in litres or gallons) that the metering pump can meter in 10,000 seconds at maximum capacity.

Memory - remaining strokes not yet processed

You can also activate the 'Memory' function extension ("memory" identifier). When 'Memory' is activated, the pump adds up the remaining strokes, which could not be processed, up to the maximum capacity of the stroke memory of 999,999 strokes. If this maximum capacity is exceeded, the pump goes into fault mode.



CAUTION!

- The pump maintains its stroke rate when changing over from 'Manual' operating mode to 'Batch' operating mode.
- When you press  [STOP/START] or the "Pause" function is activated, the 'Memory' is cleared.



In operation, the batch size can be changed more easily by using the "Batch size" continuous display.

11.2.1.4 'Analog' (option)

 → 'Menu / Information → Settings → Operating mode → Analog → ...'

The secondary display "Signal current" indicates the incoming current.

You can select 5 types of current signal processing:

- '0 - 20 mA'
- '4 - 20 mA'
- 'Linear curve'
- 'Lower side band'
- 'Upper side band'

'0 - 20 mA'

At 0 mA the pump is stationary –

At 20 mA the pump works at maximum stroke rate.

'4 - 20 mA'

At 4 mA the pump is stationary –

At 20 mA the pump works at maximum stroke rate.

With current signals of less than 3.8 mA, an error message appears and the pump stops (e.g. if a cable has broken).

'Linear curve'

The "Linear curve" symbol appears on the LCD screen. You can enter any pump stroke rate behaviour proportional to the current signal. For this purpose, enter any two points P1 (I1, F1) and P2 (I2, F2) (F1 is the stroke rate at which the pump is to operate at current I1, F2 is the stroke rate at which the pump is to operate at current I2...); this defines a straight line and thus the behaviour is specified:

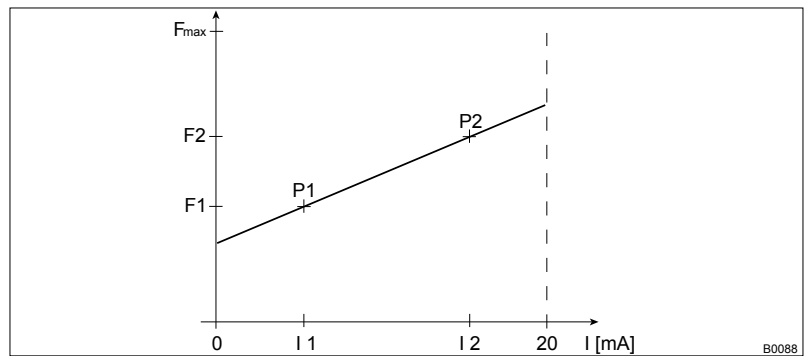

Fig. 33: Frequency-current diagram for "Linear curve"



Plot a diagram similar to the one above – with values for (I_1, F_1) and (I_2, F_2) – so that you can set the pump as desired!



The smallest processable difference between I_1 and I_2 is 4 mA ($\| I_1 - I_2 \| \geq 4$ mA).

Error processing

In the 'Error message' menu item, you can activate error processing for these types of processing.

'Lower side band'

Using this type of processing, you can control a metering pump using the current signal as shown in the diagram below.

However, you can also control two metering pumps for different feed chemicals via a current signal (e.g. one acid pump and one alkali pump using the signal of a pH sensor). To do this, connect the pumps electrically in series.

Error processing

In the 'Error message' menu item, you can activate error processing for these types of processing.

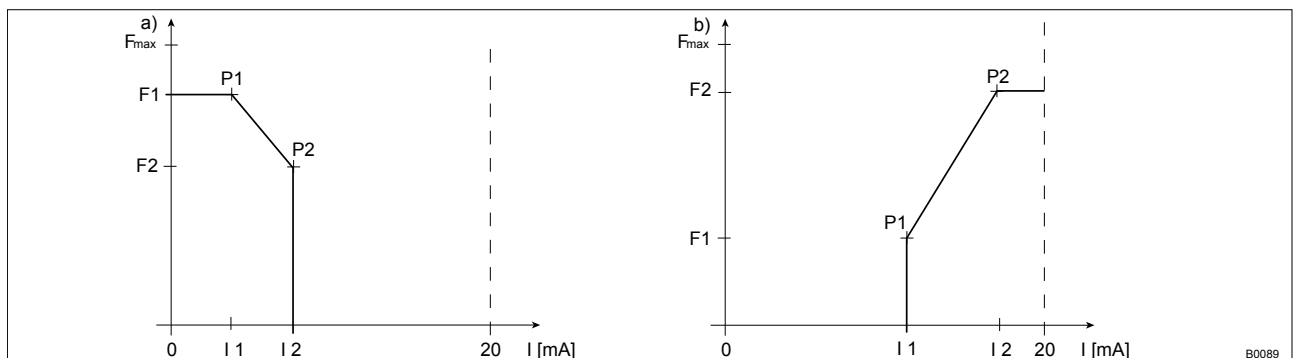

Fig. 34: Frequency-current diagram for a) Lower side band, b) Upper side band

'Upper side band'

Using this processing type, you can control a metering pump using the current signal as shown in the diagram above.

Everything functions according to the 'Lower side band' type of processing.

11.2.2 'Automatic'

☰ → 'Menu / Information' → Settings → Automatic → ...'

The 'Automatic' menu lets you set whether the unit is to meter automatically or conventionally.

'Automatic' - 'on' lets you set direct values, such as capacity, metering volume or dosing time, instead of stroke length and stroke rate. Other selection points then appear in the operating menu - refer to the chapter "Operating menu gamma/ X, complete" (in the appendix) for the selection points highlighted with a "*1".

In 'Automatic' - 'on' metering mode, the gamma/ X specifies the stroke length and the stroke rate according to the conditions determined in order to meter the set capacity.



'Automatic' - 'on' and 'Automatic' - 'off' metering modes are completely independent of each other. That is to say that 'Automatic' - 'off' metering mode does not carry over settings from 'Automatic' - 'on'.

Tab. 8: Setting ranges

	'Automatic' - 'on'	'Automatic' - 'off'
Manual, continuous	1:2,000	1:2,000
Manual, discontinuous	1:40,000	1:40,000

11.2.3 'Stroke length'

☰ → 'Menu / Information' → Settings → Stroke length → ...'

The menu does not appear with 'Automatic' 'on'!

In the 'Stroke length' menu, you can enter the stroke length manually.



In operation, the stroke length can be changed more easily via the "Stroke length" continuous display:

- Turn the [Clickwheel] to return to the "Stroke length" continuous display.
- Press the [Clickwheel] and then turn it to set the stroke length.
- Press the [Clickwheel] to save the stroke length.

11.2.4 Metering

☰ → 'Menu / Information → Settings → Metering → ...'

11.2.4.1 'Discharge stroke'

☰ → 'Menu / Information → Settings → Metering
→ Discharge stroke → ...'

In the 'Settings' - 'Discharge stroke' sub-menu, you can precisely match the pump metering flow over time to the requirements of the particular application.

This ensures that users can set the optimum discharge stroke for their application, as required:

Pos.*	Discharge stroke	Application
A.	'optimum'	For maximum precision when metering and the very best results with internal pressure measurement and special functions.
B.	'fast'	For a fast discharge stroke.
C.	'very fast'	For a super-fast discharge stroke.
D.	'sine mode'	The duration of the discharge stroke is dependent on the stroke rate for a long, sine-shaped discharge stroke.
E.	'continuous'	For a continuous discharge stroke e.g. for bottling processes. The duration of the discharge stroke is dependent on the stroke rate.
F.	'DFMa'	For optimum operation with a flow meter DulcoFlow® DFMa.

* see following drawing.

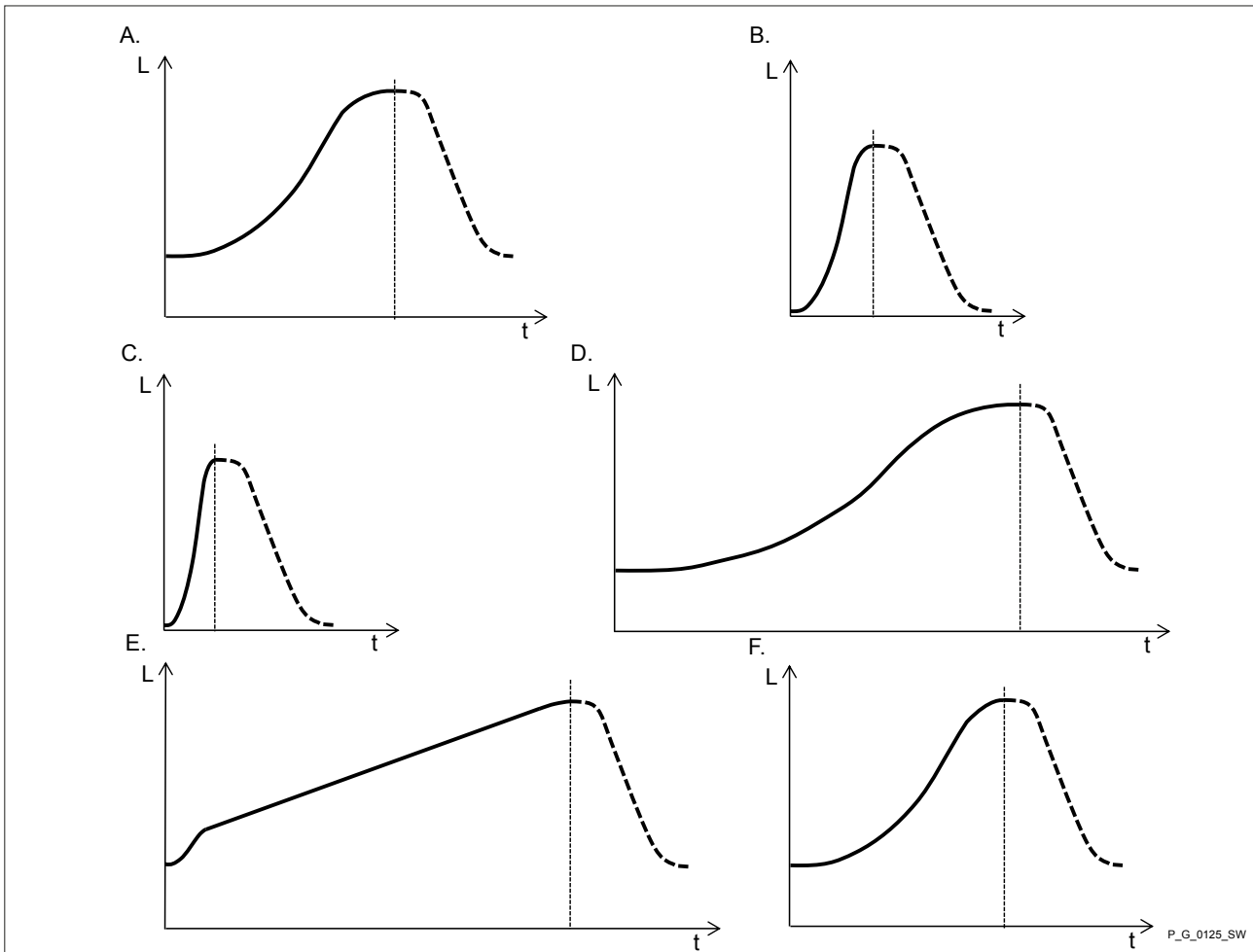

Fig. 35: Discharge stroke metering profiles with stroke L and time t (suction stroke shown as a dotted line)

11.2.4.2 'Suction stroke'

☰ → 'Menu / Information → Settings → Metering
→ Suction stroke → ...'

It is possible to selectively also slow the **suction stroke** with all these metering profiles for the discharge stroke - see . In this way, it is possible to prevent the main cause of inaccurate metering with high viscosity feed chemicals, namely the incomplete filling of the liquid end. With gaseous feed chemicals, the slow suction stroke prevents cavitation and consequently increases dosing precision.

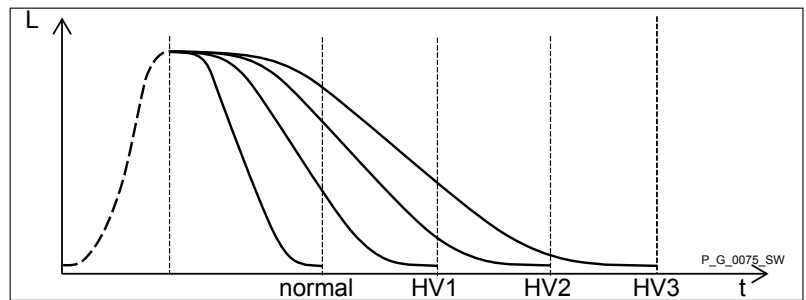

Fig. 36: Suction stroke metering profiles with stroke L and time t

Normal Normal suction stroke

HV1 Suction stroke for viscous feed chemical

HV2 Suction stroke for average viscosity feed chemical

HV3 Suction stroke for high-viscosity feed chemical



– Slowing down the suction stroke leads to a lower stroke rate and thus to a lower capacity.

'Suction stroke' setting	Maximum stroke rate Strokes/min.
Normal	200
HV1	160
HV2	120
HV3	80

11.2.4.3 'Pressure rating'

☰ → 'Menu / Information → Settings → Metering
→ Pressure rating → ...'

You can use the programmable 'Pressure rating' function to reduce the nominal pressure of the pump, thereby minimising the risk of lines rupturing.

The switch-off pressure of the permanently active overpressure monitoring falls at the same time as the pressure rating - see .

Tab. 9: Nominal pressures depending on the size of the liquid ends and the pressure ratings

Pressure rating /	4	7	10	16	20	25
Size of liquid end						
1602	X	X	X	X	-	-
2002	X	X	X	-	X	-
1604	X	X	X	X	-	-

Pressure rating /	4	7	10	16	20	25
Size of liquid end						
2504	X	X	X	-	-	X
1009	X	X	X	-	-	-
708	X	X	-	-	-	-
715	X	X	-	-	-	-
414	X	-	-	-	-	-
424	X	-	-	-	-	-

Switch-off pressure

Switch-off pressure: Pressure above which the unit is switched off for the medium term in the event of excess pressure = Pressure rating plus 10 ... 20%.

11.2.4.4 'Monitoring'

☰ → 'Menu / Information → Settings → Metering → Monitor → ...'

11.2.4.4.1 'Air lock'

☰ → 'Menu / Information → Settings → Metering → Monitor → Air lock → ...'

Should a message and the "Air lock" symbol  appear, this may mean that there is gas in the liquid end (if 'Warning' or 'Error' was set in the 'Air lock' sub-menu).

11.2.4.4.2 'Sensitivity air detect'

☰ → 'Menu / Information → Settings → Metering → Monitor → Sensitivity air detect → ...'

Using the 'Sensitivity air detect' programmable function, you can adjust the sensitivity of air detection a little to receive as few incorrect alarms as possible.

Tab. 10: There are 3 levels of sensitivity:

normal	maximum sensitivity
medium	average sensitivity
weak	lowest sensitivity. Only use at pressures of < 2 bar.

11.2.4.4.3 Message with overpressure

You can have the pump output a message in the event of overpressure using the programmable *'Message with overpressure'* function.

11.2.4.4.4 Message when no pressure

You can have the pump output a message in the event of no pressure using the programmable *'Message when no pressure'* function.

11.2.4.4.5 Cavitation

You can have the pump output a message in the event that it identifies cavitation using the programmable *'Cavitation'* function.

11.2.4.5 Compensation

Only with *'Automatic'* OFF operating mode: Using the *'Compensation'* programmable function, you can minimise the influence of back pressure oscillations and thus achieve a high level of dosing precision.





With difficult hydraulic conditions, it may be better to switch off the 'Compensation' function.

11.2.5 Concentration

 → 'Menu / Information' → Settings → Concentration → ...'

The desired mass concentration of feed chemical that will subsequently be required in the dissolving medium (e.g. the main flow) can be entered directly in the "Concentration" continuous display.

The principle of entering the concentration:

1.  Select the operating mode.
2.  Set the data for the feed chemical and dissolving medium in the *'Set up'- 'Concentration'* menu.
3.  Set the desired concentration in the "Concentration" continuous display.



- The "Concentration" continuous display only appears, if:
 - the pump is calibrated.
 - the 'Concentration' menu was run through in the operating mode used.
 - and 'Concentration control' was switched to 'active' - in the operating mode being used.
- The "Concentration" continuous display switches to the display mode "%" at concentrations above 999.99 ppm.
- When changing between operating modes, the pump saves the settings for each operating mode - providing it is connected to supply voltage.
- If the pump is to display the concentration as a volume concentration, enter "1.00" kg/l for the density of the feed chemical.

11.2.5.1 'Manual' operating mode (settings for the 'Concentration' function)

☰ → 'Menu / Information → Settings → Concentration
→ Concentration control → Flow of main medium → ...'

The "Concentration input" in 'Manual' operating mode is intended for metering a substance into pipework containing a medium flowing at a constant rate ('main flow') in such a way that it has a specific mass concentration in the flow.



CAUTION!

Danger of too high concentrations

The metering pump can continue to meter if the flow falls or stops entirely.

- Take system-based precautions to prevent the metering pump from continuing to meter in these circumstances.

The prerequisites are that:

- the flowing medium has the same density as water (1 kg/l $\hat{=}$ g/cm³)
- the mass concentration of the feed chemical is known - see the feed chemical safety data sheet (e.g. with 35% sulphuric acid: 35 %)
- the density of the feed chemical is known - see the feed chemical safety data sheet (e.g. with 35% sulphuric acid: 1.26 kg/l $\hat{=}$ g/cm³)
- The measurement unit for the liquid volume is set in the 'System → Volume unit' menu.

Procedure

**CAUTION!**

The precision of the concentration is strongly dependent on:

- the precision of the metering pump calibration.
- the precision of the inputs.

1. ➤ Calibrate the metering pump if it is not yet calibrated - see chapter 'Settings' - 'Calibration' chapter.
2. ➤ Check whether the metering pump is set to 'Automatic' - 'on' metering mode.
3. ➤ Select 'Manual' - 'Operating mode' (possible settings from other operating modes remain saved.).
4. ➤ Select 'Concentration' in the 'Set up' menu.
5. ➤ Set 'active' in the 'Concentration control' menu item and press the [Clickwheel].
6. ➤ Set the 'Main medium flow' (in the pipework) and then press the [Clickwheel].
7. ➤ Set the 'Feed chemical mass concentration' and press the [Clickwheel].
8. ➤ Set the (mass) 'Feed chemical density' and press the [Clickwheel].
 - ⇒ The 'Concentration' menu appears.
9. ➤ Press [Menu] [☰].
 - ⇒ A continuous display appears.
10. ➤ Press the [Clickwheel] to go to the "Concentration" continuous display (ppm or %).
11. ➤ Enter the required mass concentration of the feed chemical in the main flow by pressing and turning the [Clickwheel].

Tab. 11: Possible values of adjustable variables

Adjustable variable	Lower value	Upper value	Increment
Flow in m ³ /h	0000.1	9999.9	0000.1
Mass concentration in %	000.01	100.00	000.01
Mass density in kg/l	0.50	2.00	0.01

11.2.5.2 'Contact' operating mode (settings on the 'Concentration' function)

☰ ➔ 'Menu / Information ➔ Settings ➔ Concentration
➔ Concentration control ➔ Contact gap ➔ ...'

The "Concentration input" in 'CONTACT' operating mode is intended for metering a substance into pipework containing a medium flowing at a variable rate in such a way that it has a specific mass concentration in the flow.

**CAUTION!****Danger of too high concentrations**

The metering pump can continue to meter if the flow falls or stops entirely.

- Take system-based precautions to prevent the metering pump from continuing to meter in these circumstances.

The prerequisites are that:

- the flowing medium has the same density as water ($1 \text{ kg/l} \triangleq \text{g/cm}^3$)
- the mass concentration of the feed chemical is known - see the feed chemical safety data sheet (e.g. with 35% sulphuric acid: 35 %)
- the density of the feed chemical is known - see the feed chemical safety data sheet (e.g. with 35% sulphuric acid: $1.26 \text{ kg/l} \triangleq \text{g/cm}^3$)
- a contact water meter is hydraulically installed and connected to the external input of the metering pump.
- The measurement unit for the liquid volume is set in the 'System → Volume unit' menu.

Procedure**CAUTION!**

The precision of the concentration is strongly dependent on:

- the precision of the metering pump calibration.
- the precision of the inputs.

1. ▶ Calibrate the metering pump if it is not yet calibrated - see chapter 'Settings' - 'Calibration' chapter.
2. ▶ Check whether the metering pump is set to 'Automatic' - 'on' metering mode.
3. ▶ Select 'Contact' - 'Operating mode' and simply confirm the associated menu items with the [Clickwheel] (possible settings from other operating modes remain saved.)
4. ▶ Select 'Concentration' in the 'Set up' menu.
5. ▶ Set 'active' in the 'Concentration control' menu item and press the [Clickwheel].
6. ▶ Set the 'Contact gap' and press the [Clickwheel].
7. ▶ Set the (mass) 'Feed chemical concentration' and press the [Clickwheel].
8. ▶ Set the (mass) 'Feed chemical density' and press the [Clickwheel].
 - ⇒ The 'Concentration' menu appears.
9. ▶ Press [Menu] (☰).
 - ⇒ A continuous display appears.
10. ▶ Press the [Clickwheel] to go to the "Concentration" continuous display (ppm or %).
11. ▶ You can enter the desired mass concentration using the [Clickwheel].

Tab. 12: Possible values of adjustable variables

Adjustable variable	Lower value	Upper value	Increment
Contact gap in l/contact	000.10	999.99	000.01
Mass concentration in %	000.01	100.00	000.01
Mass density in kg/l	0.50	2.00	0.01

11.2.5.3 'Batch' operating mode (settings for the 'Concentration' function)

☰ → 'Menu / Information' → Settings → Concentration
 → Concentration control → Volume of main medium → ...'

The "Concentration input" in 'Batch' operating mode, is intended for metering a substance into the medium in a storage tank so that it then has a defined mass concentration in the storage tank (when batching a solution – do not forget to stir!).

The prerequisites are that:

- the medium in the storage tank has the same mass density as water ($1 \text{ kg/l} \triangleq \text{g/cm}^3$)
- the mass concentration of the feed chemical is known - see the feed chemical safety data sheet (e.g. with 35% sulphuric acid: 35 %)
- the density of the feed chemical is known - see the feed chemical safety data sheet (e.g. with 35% sulphuric acid: $1.26 \text{ kg/l} \triangleq \text{g/cm}^3$)
- The measurement unit for the liquid volume is set in the 'System → Volume unit' menu.

Procedure



CAUTION!

The precision of the concentration is strongly dependent on:

- the precision of the metering pump calibration.
- the precision of the inputs.

1. ➤ Calibrate the metering pump if it is not yet calibrated - see 'Set up' - 'Calibration' chapter.
2. ➤ Check whether the metering pump is set to 'Automatic' - 'on' metering mode.
3. ➤ Select 'Batch' - 'Operating mode' and simply confirm the associated menu items with the [Clickwheel] (possible settings from other operating modes remain saved.)
4. ➤ Select 'Concentration' in the 'Set up' menu.
5. ➤ Set 'active' in the 'Concentration control' menu item and press the [Clickwheel].
6. ➤ Set the 'Main medium volume' of the medium in the storage tank and press the [Clickwheel].
7. ➤ Set the (mass) 'Feed chemical concentration' and press the [Clickwheel].
8. ➤ Set the (mass) 'Feed chemical density' and press the [Clickwheel].
 ⇨ The 'Concentration' menu appears.

9. ▶ Press [Menu] .
 - ⇒ A continuous display appears.
10. ▶ Press the [Clickwheel] to go to the "Concentration" continuous display (ppm or %).
11. ▶ You can enter the desired mass concentration using the [Clickwheel].

Tab. 13: Possible values of adjustable variables

Adjustable variable	Lower value	Upper value	Increment
Volume in l	0000.1	9999.9	0000.1
Mass concentration in %	000.01	100.00	000.01
Mass density in kg/l	0.50	2.00	0.01

11.2.5.4 'Analogue' operating mode (settings on the 'Concentration' function)

 → 'Menu / Information' → Settings → Concentration
 → Concentration control → Max. flow of main medium → ...'

The "Concentration input" in 'Analogue' operating mode is intended for metering a substance into pipework containing a medium flowing at a variable rate in such a way that it has a specific mass concentration in the flow.



CAUTION!

Risk of incorrect concentrations

- After adjusting, check whether the concentration at various flows corresponds to the required result.

The prerequisites are that:

- the flowing medium has the same density as water (1 kg/l $\hat{=}$ g/cm³)
- the mass concentration of the feed chemical is known - see the feed chemical safety data sheet (e.g. with 35% sulphuric acid: 35 %)
- the density of the feed chemical is known - see the feed chemical safety data sheet (e.g. with 35% sulphuric acid: 1.26 kg/l $\hat{=}$ g/cm³)
- a flow meter with analogue output is hydraulically installed and connected to the external input of the metering pump.
- The measurement unit for the liquid volume is set in the 'System → Volume unit' menu.

Procedure



CAUTION!

The precision of the concentration is strongly dependent on:

- the precision of the metering pump calibration.
- the precision of the inputs.

1. ➤ Calibrate the metering pump if it is not yet calibrated - see chapter 'Settings' - 'Calibration' chapter.
2. ➤ Check whether the metering pump is set to 'Automatic' - 'on' metering mode.
3. ➤ Select 'Analogue' operating mode and confirm with the [Clickwheel].
4. ➤ Set '0...20 mA' or '4...20 mA' in the 'Select analogue' menu item and press the [Clickwheel].
5. ➤ Select 'Concentration' in the 'Set up' menu.
6. ➤ Set 'active' in the 'Concentration control' menu item and press the [Clickwheel].
7. ➤ Set the 'Max. main medium flow' (in the pipework) and press the [Clickwheel]. (It is then assigned to the current value of 20 mA).
8. ➤ Set the (mass) 'Feed chemical concentration' and press the [Clickwheel].
9. ➤ Set the (mass) 'Feed chemical density' and press the [Clickwheel].
⇒ The 'Concentration' menu appears.
10. ➤ Press [Menu] [≡].
⇒ A continuous display appears.
11. ➤ Press the [Clickwheel] to go to the "Concentration" continuous display (ppm or %).
12. ➤ You can enter the desired mass concentration using the [Clickwheel].

**CAUTION!**

- Note the decimal point.
- The mass concentration is affected by changes in the stroke rate and the stroke length.
- The pump limits the upper value of the mass concentration, because otherwise the incremental jumps when adjusting would be unacceptably large. Adjust the stroke length as necessary - do not set it under 30%.



The least significant figures of the value in the continuous display cannot be changed at will using the [Arrow keys], rather only in incremental jumps resulting from the input data.

As necessary, change the stroke length and adjust the concentration; in doing so the pump compensates via the stroke rate.

Tab. 14: Possible values of adjustable variables

Adjustable variable	Lower value	Upper value	Increment
Max. flow in m ³ /h	0000.1	9999.9	0000.1
Mass concentration in %	000.01	100.00	000.01
Mass density in kg/l	0.50	2.00	0.01

11.2.6 Calibrate

 → 'Menu / Information → Settings → Calibrate → ...'



Calibration - precision

Normally the pump does not have to be calibrated. However, the pump should be calibrated for precise metering.

With individual pumps in the product range, the capacity can systematically deviate by -5% to +10% from the specified capacity. A reproducibility of ±2% from the specified capacity remains as a deviation after calibration.



Calibration influences the menu

In 'Auto' - 'off' dosing mode: Some menus only appear if the pump has been calibrated.

Calibrate using Calibr. factor

If you already know what calibration factor is needed for the pump to achieve the desired accuracy, go to 'Calibrate' - 'Calibr. factor' and enter the appropriate calibration factor as a %.

Calibrating using a calibration procedure

If you do not know which calibration factor you need, use this calibration procedure.



WARNING!

If the feed chemical is hazardous, take appropriate safety precautions when performing the following calibration instructions. Observe the material safety data sheet for the feed chemical!



Please only calibrate using the suction hose – as shown here.

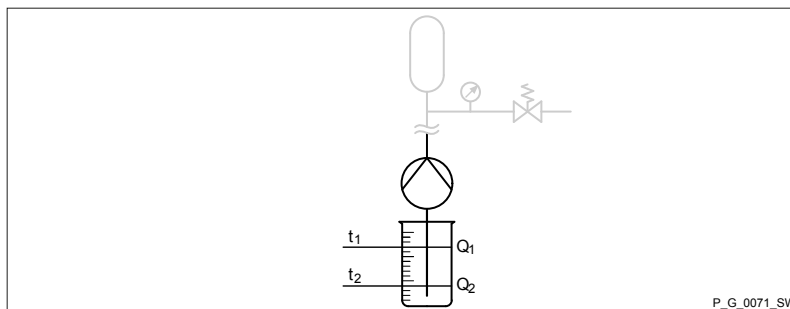

Preparation

1. Use the [Clickwheel] to scroll through the continuous displays to check whether litres or gallons have been selected.
2. If the incorrect volume unit has been selected, correct it in the 'Menu / Information → Settings → System → Volume unit' menu.
3. Check whether the capacity in the continuous display is not too low for calibration.
4. Lead the suction hose into a measuring cylinder containing the feed chemical – make sure that the pressure tube is permanently installed (operating pressure, ...!).
5. Prime the feed chemical (press [Priming]) if the suction hose is empty.

Calibration procedure

1. Record the level in the measuring cylinder.
2. Select the 'Menu / Information → Settings → Calibrate → Calibrate' menu and press the [Clickwheel].
 - ⇒ The 'Start calibration' (PUSH) menu item appears.
3. To start calibration, press the [Clickwheel].
 - ⇒ The 'Calibrate ...' menu item appears, the pump starts to pump and indicates the number of strokes.
4. After a reasonable number of strokes (a minimum of 200), use the [Clickwheel] to stop the pump.
 - ⇒ The 'Calibrate ended' menu item appears. It asks you to enter the calibration volume.
5. Determine the required metering volume (difference between initial volume - remaining volume in the measuring cylinder).
6. Use the [Clickwheel] to enter this volume in the 'Calibrate ended' menu item and close.
 - ⇒ The pump switches to the 'Calibration result' menu item - the pump is calibrated.
7. Press the [Clickwheel].
 - ⇒ The pump returns to the 'Menu / Information → Settings' menu.

11.2.7 System

→ 'Menu / Information → Settings → System → ...'

The *'System'* menu splits into the following sub-menus:

- 1 - *'Dosing head'*
- 2 - *'Volume unit'*
- 3 - *'Pressure unit'*
- 4 - *'Pressure adjustment'*
- 5 - *'Start behaviour'*

11.2.7.1 *'Dosing head'*

 → *'Menu / Information → Settings → System → Dosing head → ...'*



CAUTION!

- Should a different liquid end size be fitted, then the pump must be reprogrammed in the *'Dosing head'* sub-menu.
- Reprogram the pump to *'No dosing head'* for demonstration purposes or if operating without feed chemical.

11.2.7.2 Volume unit

 → *'Menu / Information → Settings → System → Volume unit → ...'*

You can select another unit for the volume in the *'Volume unit'* sub-menu.

11.2.7.3 Pressure unit

 → *'Menu / Information → Settings → System → Pressure unit → ...'*

In the *'Pressure unit'* sub-menu, you can select another unit for the pressure.

11.2.7.4 Pressure adjustment

 → *'Menu / Information → Settings → System → Pressure adjustment → ...'*

You can adjust the pressure value, which the pump displays in the *'Pressure adjustment'* sub-menu, if it is to differ from the pressure in the discharge line.



There is no 'Pressure adjustment' sub-menu with pumps with SER dosing heads.

Requirements:

- A manometer is installed in the discharge line.
 - Everything is set on the pump.
1. ➤ Shift to the 'Pressure adjustment' sub-menu.
 - ⇒ The 'Start pump' menu item appears.
 2. ➤ Use the [Clickwheel] to confirm 'Yes'.
 - ⇒ The pump starts up.
 - The 'Calibration pressure' menu item appears.
 3. ➤ The 'Calibration pressure' menu item shows at the top the pressure value that the pump is missing. Below that it displays an adjustable pressure value.
 4. ➤ Use the [Clickwheel] to enter the pressure value from the manometer as soon as the pressure value is stable.
 5. ➤ Use the [Clickwheel] to confirm this pressure value.
 - ⇒ The pump stops.
 - 'Pressure adjustment' is now complete.

11.2.7.5 Start behaviour

➤ 'Menu / Information ➤ Settings ➤ System
➤ Start behaviour ➤ ...'

You can specify the start behaviour of the pump once the supply voltage has been switched on in the 'Start behaviour' sub-menu.

Start behaviour	Description
'always STOP'	The pump always wakes up in "Manual stop via the [STOP/START] key" mode. It can only be started by pressing [STOP/START].
'always on'	The pump always starts immediately.
'last status'	The pump always adopts the last status it had before the supply voltage was switched off.

11.2.8 Inputs/outputs

➤ 'Menu / Information ➤ Settings ➤ Inputs/outputs ➤ ...'

The 'Inputs/outputs' menu is split into the following sub-menus:

- 1 - 'Auxiliary capacity' / 'Auxiliary frequency'
- 2 - 'Relay1' (optional)
- 3 - 'Relay2' (optional)
- 4 - 'Flow monitor' (only if connected)
- 5 - 'Diaphragm rupture' (only if connected)
- 6 - 'Pause input' (optional)
- 7 - 'Niveau monitoring'

11.2.8.1 'Auxiliary capacity' / 'Auxiliary frequency'

 → 'Menu / Information' → Settings → Inputs/Outputs
→ Auxiliary capacity / Auxiliary frequency → ...'

The programmable 'Auxiliary capacity' / 'Auxiliary frequency' function enables switch-over to an additional capacity / stroke rate that can be fixed in the 'Auxiliary capacity' / 'Auxiliary frequency' menu.

It can be activated via the "External control" terminal. If 'Auxiliary capacity' / 'Auxiliary frequency' is being used, then the identifier "AUX" appears on the LCD screen.

Refer to the "Hierarchy of operating modes, functions and fault statuses" for the order of the various operating modes, functions and fault statuses.

11.2.8.2 'Relay1 (optional)'

 → 'Menu / Information' → Settings → Inputs/outputs → Relay1
→ ...'



The setting options for the 'Relay' function are only available if a relay is fitted.

gamma/ X, GMXa

Tab. 15: Relay, physical and pre-set to ...

Identity code specification	Relay, physical	Pre-set to ...
1	1 x changeover contact 230 V – 8 A	Fault indicating relay, N/C
4	2 x N/O 24 V – 100 mA	Fault indicating relay, N/C, and pacing relay

Relay type

You can reprogram the relays to these types:

Menu setting	Effect
Timer	The relay switches when requested by the timer.
Error	The relay switches in the event of a fault message (red LED*).
Warning	The relay switches in the event of a warning message (yellow LED*).
Warning + error	The relay switches in the event of a warning message (yellow LED*) or a fault message (red LED*).
Warning, error + stop	The relay switches in the event of a warning message (yellow LED*), when stopped by  [Start/Stop] or in the event of a fault message (red LED*).
Pump active	The relay switches as soon as the pump is in standby and not stopped and not in a status like 'Pause' or if an error is pending. In the opposite case, the relay switches back again.
Stroke rate**	The relay switches with every stroke.
Cycle quantity	The relay always switches when the set metering volume is exceeded.
Metering / Batch	The relay changes its status as soon as a batch has been processed.
Bleeding	The relay opens an optionally installed bleed valve as soon as the control activates it.

* see the "Troubleshooting" chapter

** only use 'Relay 2' for this relay type (semiconductor relay).

You can set in the associated menu for certain events whether they are to be signalled as an error or warning (or not) (level, metering stroke, cavitation, ...).

The relays can also switch with programmed errors - refer to the "Troubleshooting" chapter.

Relay polarity

You can set here how a relay is to switch.

Menu setting	Effect
N/C	The relay is closed in normal mode and opens with a triggering event. (N/C)
N/O	The relay is open in normal mode and closes with a triggering event. (N/O)

11.2.8.3 'Relay2 (optional)'

 → 'Menu / Information → Settings → Inputs/outputs → Relay2 → ...'

Relay cycle quantity

You can set the metering volume for which the pacing relay is to switch once here.

For more information on 'Relay2' - see  Chapter 11.2.8 'Inputs/outputs' on page 73.





11.2.8.4 mA output

 → 'Menu / Information' → Settings → Inputs/outputs
→ mA-Output → ...'

You can enter here which signal is to be output similar to the pump capacity and as an mA signal and how the pump is to respond. The following can be selected one after the other - Table display:

1. 'mA-Output'	2. 'Select the analogue signal'	3. 'Capacity at 20 mA'	4. 'Behaviour, mA output'	5. 'Behaviour 23 mA'	6. 'Behaviour 3.6 mA'
'0...20 mA' '4...20 mA'	'Strokes / hour'	-	'No change'	-	-
			'Behaviour, mA output'	'Passive' 'Error' 'Warning' 'Warning + error' 'Warning + error + stop' 'Bleeding'	'Passive' 'Error' 'Warning' 'Warning + error' 'Warning + error + stop' 'Bleeding'
	'Litre / hour at 20 mA'	'xx.xx l/h'			

The following can be selected one after the other - Displayed as instructions:

1.  Select the current range in the 'mA-Output' display.
2.  In the 'Select the analogue signal' display, select which of the pump's capacity parameters is to be signalled by the mA output.
3.  Only with 'Litre/Hour at 20mA': Select the capacity (Litre / hour) in the 'Capacity at 20 mA' display, which is to be used for 20 mA (thereby scaling your mA range).
4.  In the 'Behavior mA output' display, select whether the mA output is to signal something or not ('No change').
5.  In the 'Behavior 23 mA' display, select which pump behaviour the mA output is to signal by 23 mA. 'Behavior 3.6 mA' acts in a similar way.



The behaviour selected under 'Behavior 23 mA' has a higher priority when signalling than the one selected under 'Behavior 3.6 mA'.

11.2.8.5 'Flow control'

 → 'Menu / Information' → Settings → Inputs/outputs
→ Flow control → ...'



The setting options for the 'Flow control' function are only available if a flow control is electrically installed. The symbol for flow control appears: .

A metering monitor, such as a Flow Control (also DulcoFlow®), can register the individual pressure impacts of the pump and report them back to the pump.

The pump switches to fault mode if this feedback is missing in a sequence, as set under 'Error tolerance'.

It is possible to switch the function on and off under 'Activation'.

Under 'at Auxiliary', it is possible to set whether the function is to be deactivated with auxiliary frequency.

11.2.8.6 'Diaphragm rupture'

 → 'Menu / Information → Settings → Inputs/outputs → Diaphragm rupture → ...'



The setting options for the 'Diaphragm rupture' function are only available if a diaphragm rupture indicator is electrically installed. The symbol for diaphragm appears .

In the 'Diaphragm rupture' sub-menu you can select whether the pump generates a warning message or an error message in the event of a diaphragm rupture.

11.2.8.7 'Pause input'

 → 'Settings → Inputs/outputs → Pause → ...'

In the 'Pause' menu you can select whether the pump switches to 'Pause' with an "Energizing (N/O)" or "Releasing (N/C)" input contact signal.

11.2.8.8 'Niveau monitoring'

 → 'Settings → Inputs/outputs → Niveau monitoring → ...'

Select in the which measuring principle is to be used for level monitoring in the 'Niveau monitoring' menu:

- '2-stage'
- 'continuous'

11.2.8.8.1 2-stage

In the 'Level warning' sub-menu, you can select for a two-stage level switch whether the pump switches to 'Level warning' with a 'Break contact' or 'Make contact' input contact signal.

In the '*Level error*' sub-menu, you can select for a two-stage level switch whether the pump switches to '*Error*' with a '*Break contact*' or '*Make contact*' input contact signal.







11.2.8.8.2 Continuous Calibrate

The ProMinent suction lance with continuous level measurement can measure the liquid level in a 30-litre canister with 5 % precision. The relevant secondary display of the gamma/ X indicates the liquid level, or the liquid level can be reported to the control panel by bus.

You can calibrate continuous level measurement in the '*Calibrate*' sub-menu.





Electrodes

You can calibrate the '*electrodes*' in this sub-menu – this is a step that is not normally necessary. If the feed chemical has a dielectric constant ϵ_r below 30, you can try to get level measurement running.

1.  Select '*Electrodes*' under '*Calibrate*'.
⇒ The '*Calibration "Air"*' display appears.
2.  Remove the level gauge from the feed chemical.
3.  Press the [*dial*].
⇒ The '*Calibration "Medium"*' display appears.
4.  Immerse the level measurement in the feed chemical up to the holding claws.
5.  Press the [*dial*].
⇒ The calibration process is completed.
6.  Check whether the level measurement is working as expected.



Perc. liquid level

Use '*Percent level*' in this sub-menu to recalibrate the level measurement if you wish to work with another maximum liquid level.

1.  Select '*Percent level*' under '*Calibrate*'.
⇒ The '*Calib. "Liquid level"*' display appears.
2.  Immerse the level measurement in the feed chemical.
3.  Use the [*dial*] to set the required percentage for this level and press the [*dial*].
⇒ The application switches back to the Start menu.
4.  Check whether the level measurement is working as expected.

Configuration

You need to enter the warning thresholds for continuous level measurement and the required unit in the '*Configure*' sub-menu.

1.  Enter the '*Warning Level Niveau*' as a % and press the [*dial*].
2.  Enter the '*Fault Level Niveau*' as a % and press the [*dial*].

3. → Select the *'Unit Level'* for the "continuous level" secondary display: select *'Percent'* or *'Liter'* and press the [dial].

11.2.9 Bleeding

☰ → 'Menu / Information → Settings → Bleeding → ...'

The *'Bleeding'* function is used for controlled bleeding of the liquid end.

The software solution is always in the pump control. The pump calls up the *'Priming'* function for bleeding. The pump can therefore pump the gas bubbles out of the liquid end even without a bleed valve (solenoid valve) – depending on the back pressure.

If the pump has "Automatic bleed" via the "relay identity code option (retrofitable), the pump can be bled via a bleed relay.

There are 2 hardware options for automatically bleeding the discharge side:

- via ProMinent's bleed module in the liquid end.
- via a customer implemented bleed facility in the discharge line.



The relay - "Relay" – "with automatic bleed" - changes its switching status for the period during which the pump is priming.

The *'Bleed'* function can be triggered in 4 ways:

- 1 - Not (*'Off'*).
- 2 - *'Periodically'* by an internal signal - defined by *'Cycle'* and *'Duration'*.
- 3 - By the *'Air lock'* internal signal
- 4 - If one of the two signals occurs (*'Both'*).

Detailed explanation:

- 1 - If 'Off' has been selected in the menu, this function is deactivated.
- 2 - If 'Periodic' was selected in the menu, then the control unit periodically triggers the bleed procedure with an adjustable 'cycle' (10 ... 1440 min = 24 h) and an adjustable 'duration' (5 ... 300 s = 5 min).

Bleeding is always triggered at the start of a period. A bleed process is also started by  [STOP/START] or by connecting the pump to mains voltage.











- 3 - If 'Air lock' has been selected in the menu, the 'Air lock' internal signal triggers the bleed procedure.

If the signal appears again within 8 minutes of the bleed procedure being carried out, the control unit repeats the bleed procedure up to a maximum of 3 times. However if the signal still appears, then an error message is generated, which has to be acknowledged via the [dial].

In the event of an 'Air lock' the option of a direct error or warning message disappears for the 'Air lock' signal. The corresponding menu branch in the 'Settings' menu is also hidden. The signal is only available for the 'Bleed' function.

- 4 - If 'Both' has been selected in the menu, then each trigger can trigger a bleed process.

Sequence of the bleed procedure (automatic):

1.  The pump control stops the normal metering operation - the  "Stop Pause" symbol appears on the LCD screen.
2.  Only with bleed relay: After 1 s, the pump control opens the bleed valve on the liquid end (via the bleed relay and the solenoid valve).
3.  1 s later, the pump starts to run at a high stroke rate (like during priming) - the "Air lock" symbol  appears on the LCD screen instead of the "Stop Pause" symbol.
4.  The pump operates in this way for the total set time.
5.  Once the set time has elapsed, the pump stops – the "Stop Pause" symbol  appears on the LCD screen again.
6.  Only with bleed relay: After 1 s the pump control closes the liquid end bleed valve.
7.  After 1 s the "Stop Pause" symbol  disappears and the pump recommences normal operation.

If the pump was in the "Stop" state at the time of triggering ( [STOP/START], Pause, Error), the start of the bleed procedure is delayed - until this state has been cleared.

If the pump switched to "Stop" state during the bleed procedure, the pump control jumps immediately to phases 5 and 6. - see above. This definitely cancels the bleed procedure. As soon as the "Stop" state is cleared, the bleed procedure starts from the beginning.

11.2.10 'Priming time'

 → 'Menu / Information' → Settings → Priming time → ...'

In the 'Priming time' menu, you can select how long the metering pump is to prime once  [Priming] has been pressed.





In operation, the stroke length can be changed more easily using the "Priming time" display:

- Press  [Priming] - the pump starts to prime.
- Turn the [Clickwheel] to set the priming time.
- Press the [Clickwheel] to save the priming time.

11.2.11 'Set time'

 → 'Menu / Information → Settings → Set time → ...'

You can set the time in the 'Set time' menu.

1.  Use the dial to adjust a figure.
2.  Use  [Priming] to move to the next figure.

Under 'Auto. Summertime' you can select whether you wish to change over to 'Summertime'.

You can also state when the pump is to change to and from 'Summertime'.

Check under 'Location' whether the pump is also set to your 'hemisphere' of the world.

11.2.12 'Date'

 → 'Menu / Information → Settings → Date → ...'

You can set the date in the 'Date' menu.

11.3 Timer

 → 'Menu / Information → Timer → ...'



- *Please first read this chapter completely to gain an overview. You will then understand the timer better when working through the chapter.*

The timer gamma/ X can do the following at predefined times and intervals or event-dependent:

- open / close the relays
- switch the level of a Config I/O output
- be triggered by the level at a Config I/O input
- start a delayer
- switch operating mode
- operate the pump work at a defined capacity or stroke rate / stroke length

- stop / start the pump
- trigger a batch ('Batch (time)')

11.3.1 Activation / deactivation

☰ → 'Menu / Information → Timer → Activation → ...'



You can only program the timer when 'Activation' is set to 'inactive'.

- ➔ To program the timer, set 'Activation' to 'inactive'.
 - ⇒ The first line of the timer menu 'Timer state' then shows 'Inactive'.
- ➔ To activate the timer, set 'Activation' to 'active'.
 - ⇒ The first line of the timer menu 'Timer state' then displays 'active'.

The timer starts working - the timer identifier ⌚ is visible in the continuous display.



When 'Activation' is set to 'active', the timer software generates the status of the pump which the pump would have precisely had at this time if it had been set to 'active' without any interruption.

Delayed, linked actions are unaffected by this.

11.3.2 Setting the timer

☰ → 'Menu / Information → Timer → Set Timer → ...'

You can create commands (also known as "program lines") for a timer program in the 'Set Timer' menu.

You can create up to 99 commands (program lines).

Create the command as follows:

- 1 - Create a 'new' command (program line)
- 2 - Select the 'Triggering event' (trigger) and the time and/or interval if necessary
- 3 - Select 'Action' and a value, if necessary
- 4 - Check the command
- 5 - Create the next command – if necessary

The following administration functions are available to manage the commands (program lines):

- 1 - Reprogram program line ('New')
- 2 - Check program line ('Show')
- 3 - Change program line ('Change')
- 4 - Clear individual program line ('Clear')
- (5 - Clear the entire program ('Clear all' one level higher))

**CAUTION!**

The pump does not perform any plausibility check. Please ensure before using that the timer actually does what you expect of it. Please consider the consequences for your system.

**CAUTION!**

A program set up in 'Automatic' - 'on' metering mode will not function in 'Automatic' - 'off' metering mode and vice versa.

**CAUTION!**

If you wish to use automatic summer time adjustment ('Settings' - 'Time') avoid any triggering events between 02:00 a.m. and 03:00 a.m.

**Restriction with day numbers**

If you wish to start an action on a certain day of each month, note that the timer only permits days 01 - 28.

**Using Config I/Os**

If you wish to use Config I/Os as inputs or outputs, you first need to configure them as a 'Timer input' or 'Timer output' under 'Menu / Information' → 'Settings' → 'Config I/Os' → ...

11.3.2.1 Reprogramming program line ('new')

**CAUTION!**

If the 'Timer state' is set to 'active', the pump can neither be set nor programmed!

To do so, set the 'Timer state' under 'Activation' to 'inactive'.

11.3.2.1.1 Principle construction of a program line

In principle, an (imaginary) program line / instruction is set up as follows:

Time event (trigger)		Action	
Workdays 1 (Mo-Fr)	Time of day 12:00	Manual	20.00 l/h

This corresponds to the following instruction:

WHEN triggering event, THEN action

The **time event (trigger)** defines what action or at what time an action is to take place.

The **action** defines which type of action is to take place.

The finished program line/ instruction looks like this:

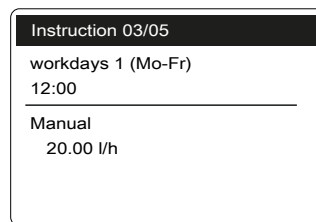

B1106

Example

Time event (trigger)		Action	
Workdays 1 (Mo-Fr)	Time of day 12:00	Manual	20.00 l/h

The example means:

When it is 12:00 on a workday, then the pump is to work in 'Manual' operating mode at 20.00 l/h.

Tab. 16: Time events (triggers)

Time events (triggers)	Description	Remark
Time	Switching time reached	For more information - see Chapter 11.3.2.1.3 'Selecting cyclic time events and switching point' on page 85
'Init'	Thus declared is started at the beginning of the program process	Defines starting conditions - see Chapter 11.3.2.1.2 'Init' Initial conditions' on page 85

You can select an action and also a value:

Tab. 17: Action

Action	Description	Value
'Manual'	Switch over in this operating mode	Litre/h ('Dos. capacity')
'Manual'	Switch over in this operating mode	Litre/h *1 ('Dos. capacity')
		Strokes/h *2 ('Metering rate') + 'Stroke length'
'Halt'	Stop pump	--

Action	Description	Value
'Relay1 **'	Have the relay switch to status ...	open closed
'Relay2 **'	Have the relay switch to status ...	open closed
'Contact'	Switch over in this operating mode	--
'Batch (input)'	Switch over in this operating mode	--
'Analogue'	Switch over in this operating mode	--
'Frequency *2'	The pump runs at this stroke rate	Strokes/h ('Metering rate')

*1: only available in 'Automatic' operating mode - see chapter 'Settings' - 'Automatic'

*2: only available, if metering is done traditionally/conventionally - see chapter 'Settings' - 'Automatic'

** Option; needs to be assigned to the 'Timer' (under 'Settings → Inputs/Outputs → Relay → Relay type' - refer to this chapter of the operating instructions under 'Settings')

Tab. 18: Selected value ranges

Designation	Value range
Line numbers	01 ... 99
Day (date)	01 ... 28
Time of day (hours)	00 ... 23
Seconds	0001 ... 9999

11.3.2.1.2 'Init' Initial conditions

The triggering event 'Init' can be used to set initial conditions at the beginning of a program sequence.

Example

triggering event (trigger)		Action	
Init	-	Relay 2	closed
Init	-	Contact	-

The example means:

As soon as the programme is started (via 'Timer → Activation → active' or power supply on), 'Init' sets 'Relay 2' to 'closed' and the 'Operating mode' to 'Contact'.

11.3.2.1.3 Selecting cyclic time events and switching point

The cyclic time events periodically trigger actions. That is why a program line consists of a cycle and a switching point:

The **cycle** specifies after which time the action is to be repeated.

The **switching time** specifies when the action is to take place.

Example

Time events (triggers)		Action
Cycle	Switching time	
Workdays 1 (Mo-Fr)	Time of day 12:00	Manual

Tab. 19: Cyclic time events

Cycle	Time
'hourly'	hourly at mm. Minute
'daily'	daily at the time mm.ss, Monday to Sunday
'Workdays 1 (Mo-Fr)'	daily at the time mm.ss, Monday to Friday
'workdays 2 (Mo-Sa)'	daily at the time mm.ss, Monday to Saturday
'Weekend (Sa+Su)'	daily at the time mm.ss, Saturday and Sunday
'weekly'	weekly at the time mm.ss on day xxxxxx.
'monthly'	monthly at the time mm.ss on the day dd. Day* of the month

* Value range is restricted to day 01 – 28



CAUTION!

If you wish to use automatic summer time adjustment ('Settings' - 'Time') avoid in principle any time events between 02:00 and 03:00.



A time event lets you trigger an action precisely to the minute.

If the action is to be triggered precisely to the second, then you need to set up your programming on a delayer.

11.3.2.2 1 time event - several actions

You can assign 1 time event to several actions. To do so, always use the same cycle and the same switching time! :

Example

No.	Time event (trigger)		Action	
01	Workdays 1 (Mo-Fr)	Time of day 12:00	Halt	-
02	Workdays 1 (Mo-Fr)	Time of day 12:00	Batch (input)	50 strokes
03	Workdays 1 (Mo-Fr)	Time of day 12:00	Relay 1	-closed
04	-	-



- For details on the sorting sequence of the program lines see ↗ 'Sorting sequence' on page 87.
- The timer program can have a maximum of 99 program lines.

11.3.2.3 Check program lines ('Show')

☰ → 'Menu / Information → Timer → Set timer → Show'

'Show' lets you check individual program lines / instructions.

1. ➤ Press the [Clickwheel] on a program line / instruction.

⇒ This display appears:

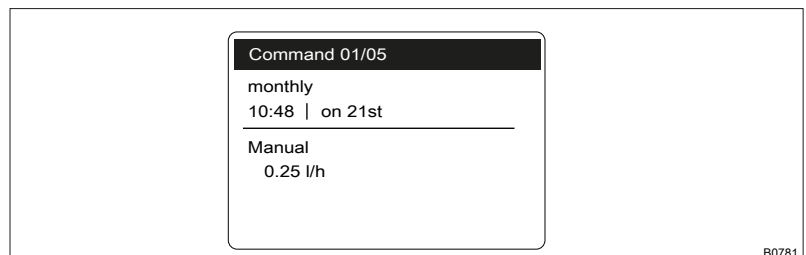

Above the line Time event (trigger) and possible value
Below the line Action and value, if required

2. ➤ Turn the [Clickwheel].

⇒ Scroll from instruction to instruction.

The number of the program line or instruction (and the number of the last program line or instruction) appears at the top in the dark bar.

3. ➤ Pressing the [Clickwheel] returns you to 'Set timer'.



As the timer software automatically sorts the program lines, the numbers of the program lines can change if you change something.

Sorting sequence

The timer software automatically sorts every newly programmed program line / instruction after completing it (press the [Clickwheel]) below the other program lines.

The 1st sorting criterion is the type of **time event (trigger)** (for the sequence refer to ↗ *Further information on page 84* and ↗ *Further information on page 85*).

Time-dependent program lines are ordered below each other initially after the **Switching point** (2nd sorting criterion)



then after the length of the **Cycle** (3rd sorting criterion).

The 4th sorting criterion is the type of **action** (see also the programming examples at the end of these instructions).

A purely time-controlled timer program will also run in this sequence.



11.3.2.4 Change program lines ('Change')

 → 'Menu / Information → Timer → Set timer → Change'

1.  Use the [Clickwheel] to select the required program line / instruction according to its number and press the [Clickwheel].
2.  Click through the instruction and change it.
 - ⇒ The timer software sorts a changed program line / instruction after completion with the [Clickwheel] possibly differently in between the other program lines (Rules - see  'Sorting sequence' on page 87).

11.3.2.5 Clear individual program lines ('Clear')

 → 'Menu / Information → Timer → Set timer → Clear'

1.  Use the [Clickwheel] to select the required program line / instruction according to its number.
2.  The program line will be cleared as soon as you press the [Clickwheel].
 - ⇒ The timer software re-sorts the remaining programme lines (Rules - see  'Sorting sequence' on page 87).



Clear all program lines

The option to clear all program lines is to be found one level higher in the menu:

 → 'Menu / Information → Timer → Clear all'

11.3.3 Clear all

 → 'Menu / Information → Timer → Clear all → ...'

Use the 'Clear all' menu to clear all instructions (the entire program).

11.3.4 Examples

Requirements:

- You have already worked with the pump type
- The time has been set (possibly set under 'Settings → Set time → Time'. Only possible with 'Timer state' - 'Inactive').

Example of "Weekday metering"*Task:*

The pump is to meter 2 litres every half hour every weekday (Mon-Fri) between 8:00 and 11:00.

Solution:

As you define switching times with the timer, you need to first define the switching points at 08:30, 09:30 and 10:30.



To meter 2 litres, the pump needs to work in 'Manual' 'Mode' for 10 min at a 'Dos. capacity' of 12,000 l/h. A 'Dos. capacity' of 12,000 l/h is thereby added to the switching points.

You also need to define the switching times to stop the pump at 08:40, 09:40 and 10:40 - paired with the 'Halt' action.

Tab. 20: Program as program lines / instructions

No.	Time event	Action		Comment	
		Switching time	Capacity		
01	Workdays 1 (Mo-Fr)	08:30	Manual	12,000 l/h	Meter at 12,000 l/h
02	Workdays 1 (Mo-Fr)	08:40	Halt	-	Halt
03	Workdays 1 (Mo-Fr)	09:30	Manual	12,000 l/h	Meter at 12,000 l/h
04	Workdays 1 (Mo-Fr)	09:40	Halt	-	Halt
05	Workdays 1 (Mo-Fr)	10:30	Manual	12,000 l/h	Meter at 12,000 l/h
06	Workdays 1 (Mo-Fr)	10:40	Halt	-	Halt

How to enter the program lines / instructions:

1. ▶ To program the timer, set  → 'Menu / Information' → 'Timer' → 'Activation' to 'inactive'.
 - ⇒ The first line of the timer menu 'Timer state' then shows 'inactive'.
2. ▶ Always enter the program / instructions from the table, above, into the newly created instruction under 'Timer' → 'Set timer' → 'new' → ...' (Do not get irritated: the timer program automatically sorts the instructions).
3. ▶ To activate the timer, set 'Activation' to 'active'.
 - ⇒ The first line of the timer menu 'Timer state' then displays 'active'.
 - The timer starts working - the timer identifier  is visible in the continuous display.

4. ▶ Test your programming!

The secondary display "Timer" can help with this as it shows the next instruction and the remaining time. (To access this secondary display, press the [Clickwheel] in a continuous display until a long series of small circles appears below - immediately turn the [Clickwheel] to navigate to the last circle and press the [Clickwheel].)

The continuous display itself shows information on the current status of the pump in the dark bar.



If something has been entered incorrectly:

- *Either press  in the current program line and enter the correct values*
- *or search for the program line in 'CHANGE' (automatic sorting!). Now press the [Clickwheel], allow the program to run through the program lines again and enter the values correctly*
- *or use 'Clear' to select the program line and clear*
- *or clear everything using 'Clear all' (one level higher).*

11.3.5 Timer information

Status as soon as the programmed pump is connected to the power supply:

The timer software now generates the status of the pump which the pump would have precisely had at this time if it had not been disconnected from the power supply.

Effective settings after switching between Timer 'active' and 'inactive':

The timer settings are saved and become effective again when 'inactive' switches to 'active'.

The operating mode settings are saved and become effective again when 'active' is switched to 'inactive'.

Storage period of your programming:

The pump stores your programming for up to 20 years.
(The calibration and timer data is maintained for up to 100 years).
The time is retained without power supply for approx. 2 years.

11.3.6 Typical pitfalls Timer functional faults

Problem	Possible cause of fault	Remedy
The pump starts pumping unexpectedly.	The timer clears every "Manual" stop when activated - see "Timer behaviour on start"	Enter an ' <i>Init</i> ' instruction with ' <i>Halt</i> ' action.
The timer does not react to a contact signal at the corresponding pin of the "Config I/O" socket.	Config I/O was not configured as "Config I/O" - "Input" in the ' <i>Menu / Information</i> → <i>Settings</i> → <i>Inputs/Outputs</i> → ...' menu.	Configure Config I/O as "Config I/O" - "Input" in the ' <i>Menu / Information</i> → <i>Settings</i> → <i>Inputs/Outputs</i> → ...' menu.
The timer does not set a Config I/O output.	Config I/O was not configured as "Timer" - "Input" in the ' <i>Menu / Information</i> → <i>Settings</i> → <i>Inputs/Outputs</i> → ...' menu.	Configure Config I/O as a "Timer" - "Input" in the ' <i>Menu / Information</i> → <i>Settings</i> → <i>Inputs/Outputs</i> → ...' menu.
A ' <i>Delayer</i> ' does not trigger an ' <i>Action</i> '.	Different delay times have been defined for the same ' <i>Delayer</i> ' but this delayer is stopped and becomes inactive after the shortest delay time.	Create a further ' <i>Delayer</i> ' for the longer delay time.

11.3.7 Brief explanation of selected functions

Time event (trigger)

An event can be triggered either time-dependent or event-controlled.

- 1 - Time events (really time-dependent) are processed precisely to the minute.
- 2 - Initialisation ('*Init*') is executed at the start of the program ('*Timer* → *Activation* → *active*' or when the power supply is connected) to obtain a defined status of the system.
- 3 - "Config I/O" inputs can trigger something if the input potential changes from 1 to 0 or with a falling edge or if the potential-free contact is closed.
- 4 - Delayers can trigger an action as soon as their time has expired - precisely to the second.

Actions

These are the '*Actions*' which the timer executes as soon as a '*time event*' has occurred.

Initialisation

When '*Activation*' is set to '*active*', the timer software generates the status of the pump which the pump would have precisely had at this time if it had been set to '*active*' without any interruption.

This does not relate to delayed, linked actions.

The initial commands ('*Init*') can be used to program a defined switch-on status. Initial commands have priority over time commands.

Outputs

Those relays which were connected with the relay option are designated as outputs. There can be up to 2 relays.

Pins 1 - 3 of the "Config I/O" socket can be inputs and outputs. That can be programmed.

Inputs

Pins 1 - 3 of the "Config I/O" socket can be inputs and outputs. That can be programmed.

Delayer

Delayers are started event- or time-controlled. On expiry of the delay time, the delayer itself can trigger any actions.

11.4 'Service'

☰ → 'Menu / Information → Service → ...'

11.4.1 'Access protection'

☰ → 'Menu / Information → Service → Access protection → ...'

You can lock parts of the setting options here.

The following locking options are available:

Selection	Point ①	Point ②
'None'	-	-
'Lock menu'	X	-
'Lock all'	X	X

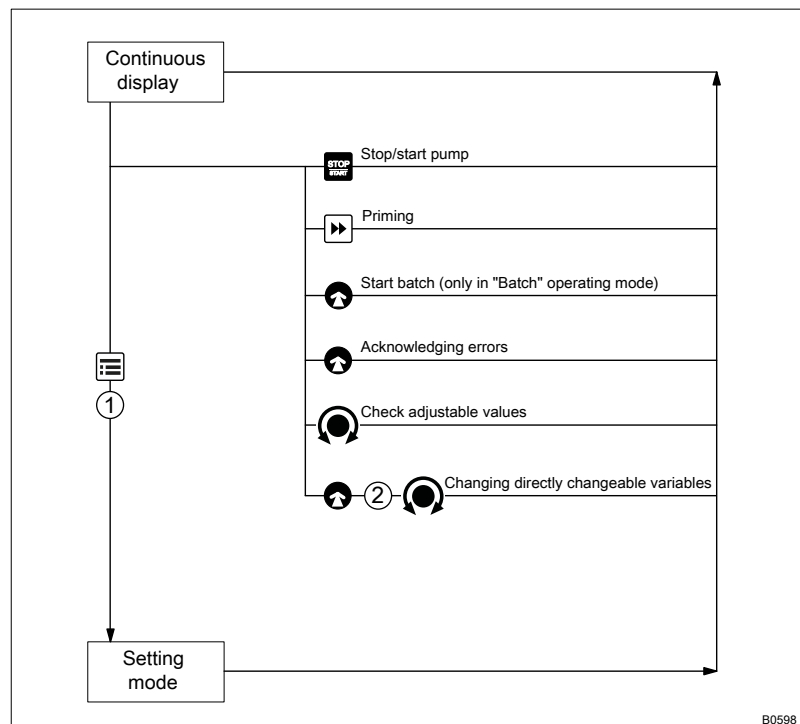



Fig. 37

If you have set a 'Password' - see below, then the identifier  will appear after 1 minute in the top left and the specified areas will be locked, if no key has been pressed in the meantime.

Both locks use the same 'Password'.

11.4.2 'Password'

 → 'Menu / Information' → Service → Password → ...'

You can enter a password of your choice in the 'Change password' menu.

11.4.3 'Clear counters'

 → 'Menu / Information' → Service → Clear counters → ...'

You can reset the counters to "0" in the 'Clear counters' menu:

- 'Stroke counter' (total number of strokes)
- 'Volume counter' (total litres)
- 'Contact memory'
- 'All'

 To clear: exit the menu by briefly pressing the [Clickwheel].

The values have increased since commissioning the pump, the last calibration or the last deletion.

11.4.4 'Error log book'

 → 'Menu / Information' → Service → Error log book → ...'

You can view the list of 'Log book entries' here.

A 'filter' helps with the overview.



If you need more detailed log book entries:

The metering pump gamma/ X with Bluetooth functionality can display a more extensive log file with pump-related events and e-mail it using a Bluetooth-compatible Android smart device and the "gamma/ X" app.

11.4.4.1 Log book entry - Detailed view

Press the [Clickwheel] to obtain more information about a log book entry.

Tab. 21: Information on the detailed view

Line	Information
1	Date/time
2	Type of entry (fault, warning ...)
3	Total operating time, total number of strokes

Line	Information
4	Switching-on duration, stroke rate since switching on
5	Room temperature, status information on the error (for developers)

11.4.5 *'Diaphragm replacement'*

 → *'Menu / Information → Service → Diaphragm replacement → ...'*

You can move the slide rod into the "replacement position" here with *'To change position'* to enable the diaphragm to be replaced more easily.

11.4.6 *'Display'*

 → *'Menu / Information → Service → Display → ...'*

You can set the *'Contrast'* and the *'Brightness'* of the LCD screen here.

11.4.7 *'Factory settings'*

 → *'Menu / Information → Service → Factory setting → ...'*

You can reset the pump to its factory settings here by selecting *'Yes'*.

The password is the last 4 digits of the serial number.

11.4.8 Diaphragm part number: XXXXXXXX

 → *'Menu / Information → Service → Diaphragm part number: XXXXXXXX → ...'*

You can read off the part number (order number) of the correct diaphragm here.

11.4.9 Spare parts kit part number: XXXXXXXX

 → *'Menu / Information → Service → Spare parts kit part number: XXXXXXXX → ...'*

You can read off the part number (order number) of the correct spare parts kit here.

11.5 *'Language'*

 → *'Menu / Information → Language → ...'*

You can select the desired operating language in the *'Language'* menu.

12 Operation



WARNING!

Fire hazard with flammable media

Only with combustible media: These may start to burn when combined with oxygen.

- During filling and draining of the liquid end, an expert must ensure that feed chemical does not come into contact with oxygen.

This chapter describes all the operating options in a continuous display (several symbols and the pressure display appear at the top in the black bar) for the trained person at the pump.



- Please also refer to the "Operating/Setting Overview" and "Continuous Displays and Secondary Displays" overviews at the end of the operating instructions and also the "Overview of Equipment and Control Elements" chapter.

12.1 Manual operation

Stop/start pump

Stop the pump: Press  [STOP/START].

Start the pump: Press  [STOP/START] again.

Priming

Press  [Priming].

Turn the [Clickwheel] to extend or shorten the priming time during priming.

Starting a batch

In 'Batch' operating mode: Press the [Clickwheel] in the 'Push' continuous display.

Acknowledging errors



Press the [Clickwheel] to acknowledge error messages that require acknowledgement.

Checking adjustable variables

In a continuous display: Another continuous display will appear each time the [Clickwheel] engages when turned. (The number depends on the configuration).

Changing directly changeable variables

Changing a variable in the relevant continuous display:

1.  Press the [Clickwheel].
 - ⇒ The variable can be changed (highlighted).
2.  Turn the [Clickwheel].
 - ⇒ The variable is changed.
3.  Press the [Clickwheel].
 - ⇒ The variable is saved (the highlighting disappears).

If the "lock" - "lock all" has been set - see  'Set Up Overview of the gamma/ X' on page 97, first enter the 'Password' after pressing the [Clickwheel].

List of directly changeable variables:

- Capacity
- Stroke rate
- Stroke length
- Factor
- Contact volume
- Batch dosing time
- Concentration

Set Up Overview of the gamma/ X

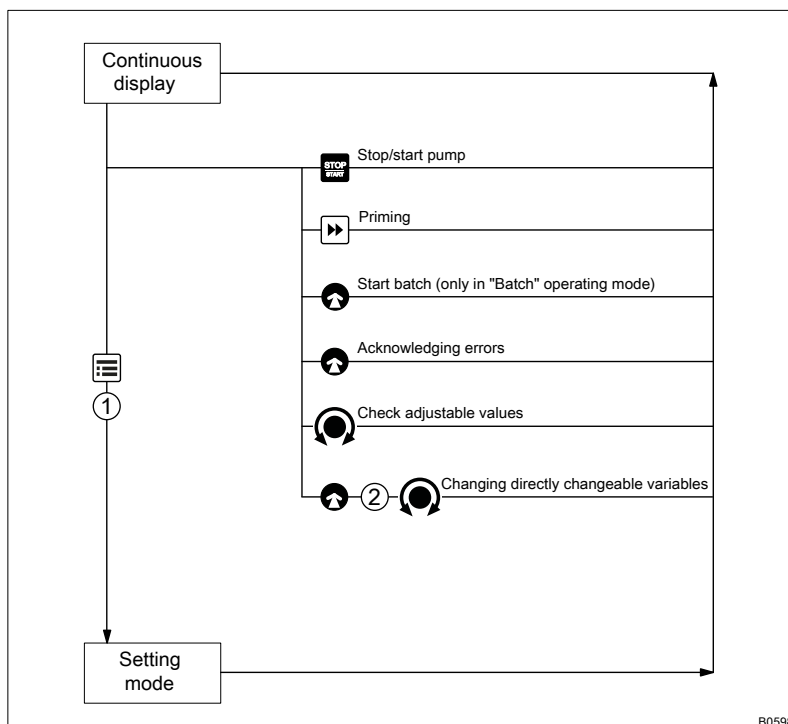



Fig. 38: Control options using keys and locking options

-  Press [Clickwheel]
-  Turn [Clickwheel]
- ① "Lock menu"
- ② "Lock all"

13 Maintenance



WARNING!

It is mandatory that you read the safety information and specifications in the "Storage, Transport and Unpacking" chapter prior to shipping the pump.



WARNING!

Fire hazard with flammable media

Only with flammable media: They can be ignited by oxygen.

- The pump may not work if there is a mixture of feed chemical with oxygen in the liquid end. A specialist may need to take appropriate actions (using inert gas, ...).



CAUTION!

Warning of feed chemical spraying around

Feed chemical may spray out of the hydraulic components if they are tampered with or opened due to pressure in the liquid end and adjacent parts of the system.

- Disconnect the pump from the mains power supply and ensure that it cannot be switched on again by unauthorised persons.
- Ensure that the system is at atmospheric pressure before commencing any work on hydraulic parts of the system.

Third-party spare parts for the pumps can lead to problems when pumping.

- Only use original spare parts.
- Use the correct spare parts kits. In the event of doubt, refer to the exploded views and ordering information in the appendix.

Standard liquid ends:

Interval	Maintenance work	Personnel
Quarterly*	<ul style="list-style-type: none"> ■ Check that the hydraulic lines are fixed firmly to the liquid end. ■ Check that the discharge and suction valve are tightly fitted. ■ Check that the entire liquid end is leak-tight - particularly around the leakage hole - refer to Fig. 39. ■ Check that the flow is correct: Press [Priming] to allow the pump to prime briefly. ■ Check that the electrical connections are intact. ■ Check the integrity of the housing. ■ Check that the dosing head screws are tight. 	Technical personnel

* with normal loading (approx. 30% of continuous operation).

With heavy-duty loading (e.g. continuous operation): Shorter intervals.

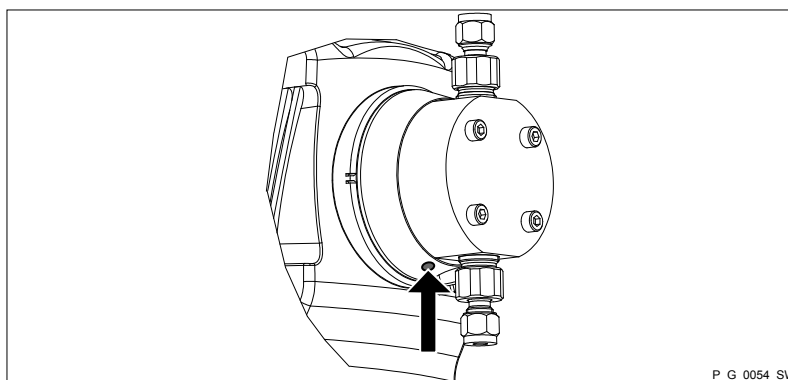

Fig. 39: The leakage hole

Interval	Maintenance work	Personnel
Annually*	<ul style="list-style-type: none"> Check the diaphragm for damage - refer to "Repair". 	Technical personnel

* with normal loading (approx. 30% of continuous operation).

With heavy-duty loading (e.g. continuous operation): Shorter intervals.

Check the metering diaphragm more frequently or use a diaphragm rupture indicator with feed chemicals that put particular pressure on the diaphragm, e.g. those containing abrasive additives.

Liquid ends with vent valve:

Interval	Maintenance work
Quarterly*	<p>In addition:</p> <ul style="list-style-type: none"> Check that the bypass line is fixed firmly to the liquid end. Check that the vent valve is tight. Check the pressure and bypass line for kinks. Check that the vent valve is operating correctly.

* with normal loading (approx. 30% of continuous operation).

With heavy-duty loading (e.g. continuous operation): Shorter intervals.

Tightening torque

Data	Value	Unit
Tightening torque for screws:	4.5 ... 5.0	Nm

14 Repair

Safety information

- User qualification, mechanical repair: trained and qualified personnel.
- User qualification, electrical repair: Electrical technician.



WARNING!

Contact with the feed chemical

Wetted parts are exposed and touched during repair work.

- Protect yourself against the feed chemical if it is hazardous. Read the material safety data sheet for the feed chemical.



CAUTION!

Warning of feed chemical spraying around

Feed chemical may spray out of the hydraulic components if they are tampered with or opened due to pressure in the liquid end and adjacent parts of the system.

- Disconnect the pump from the mains power supply and ensure that it cannot be switched on again by unauthorised persons.
- Ensure that the system is at atmospheric pressure before commencing any work on hydraulic parts of the system.



WARNING!

Fire hazard with flammable media

Only with flammable media: They can be ignited by oxygen.

- The pump may not work if there is a mixture of feed chemical with oxygen in the liquid end. A specialist may need to take appropriate actions (using inert gas, ...).

14.1 Replacing the diaphragm

INFORMATION: The order no. (part number) of the appropriate diaphragm or the spare parts kit can be found at the end of the 'Service' menu.

- Put in place protective measures, if necessary.
- Adhere to the material safety data sheet for the feed chemical.
- Prevent the escape of feed chemical.

1. ➤ Ensure that the system is at atmospheric pressure.
2. ➤ Empty the liquid end (turn the liquid end upside down and allow the feed chemical to run out; flush out with a suitable medium; flush the liquid end thoroughly).

3. ➤ Set up  ➔ 'Service ➔ Diaphragm replacement ➔ To change position'

⇒ The pump moves the diaphragm away from the backplate.

INFORMATION: Now leave the pump connected to the mains/power supply so that this state is maintained.

4. ➤ Unscrew the hydraulic connectors from the discharge and suction side.
5. ➤ With types with coarse/fine degassing: Firstly remove the coarse/fine bleed valve (grip), then lift off the cover of the liquid end with a screwdriver.

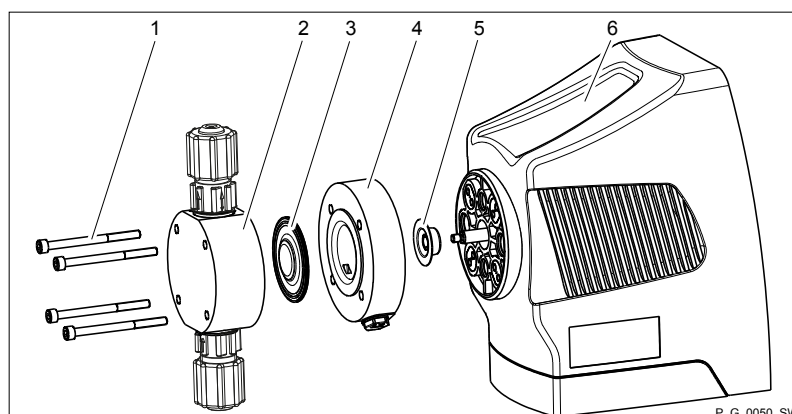



Fig. 40: Partially exploded view of liquid end

- 1 Screws
- 2 Dosing head
- 3 Diaphragm
- 4 Backplate
- 5 Safety diaphragm
- 6 Pump housing

6. ➤ Remove the screws (1).
7. ➤ Remove the dosing head (2) plus screws (1) from the pump - see figure
8. ➤ Loosen the diaphragm (3) from the drive axle with a gentle backwards turn in an anticlockwise direction.
9. ➤ Fully unscrew the diaphragm (3) from the drive axle.
10. ➤ Remove the backplate (4) from the pump housing (6).
11. ➤ Check the condition of the safety diaphragm (5) and replace it if necessary.
12. ➤ Push the safety diaphragm (5) onto the drive axle only until it lies flush with the pump housing (6).

- 13.▶ Tentatively screw the new diaphragm (3) onto the drive axle as far as the stop - ensure that this is successful, otherwise the pump will not subsequently meter precisely.
 - 14.▶ Unscrew the diaphragm (3) again.
 - 15.▶ Place the backplate (4) onto the pump housing (6).
 - Make sure that the leakage hole points downwards when the pump is subsequently fitted - see figure in the "Maintenance" chapter.
 - Place the backplate (4) immediately into the correct position on the pump housing (6). Do not twist the backplate on the pump housing to ensure that the safety diaphragm (5) does not become warped.
 - 16.▶ Place the diaphragm (3) into the backplate (4).
 - Do not over-tighten the diaphragm (3) in the following step.
 - Ensure that the backplate (4) remains in its position so that the safety diaphragm does not become warped.
 - 17.▶ Hold the backplate (4) firmly and screw the diaphragm (3) in a clockwise direction until it is sitting tightly.
 - 18.▶ Place the dosing head (2) with the screws (1) onto the diaphragm (3) and the backplate (4) - ensure that the suction connector points downwards when the pump is in its subsequent fitting position.
 - 19.▶ Set up  → 'Service → Diaphragm replacement → Back'
⇒ The pump moves the diaphragm back to the backplate.
 - 20.▶ Gently tighten the screws (1) and then tighten them cross-wise. See below  'Tightening torque' on page 102 for the tightening torque.
 - 21.▶ With types with coarse/fine degassing: Allow the cover of the liquid end to lock into the dosing head, then press the grip of the coarse/fine bleed valve into the dosing head.
- INFORMATION:** Check the tightening torque of the screws after 24 hours of operation.

Tightening torque

Data	Value	Unit
Tightening torque for screws:	4.5 ... 5.0	Nm

14.1.1 Replacing the vPTFE diaphragm

Spare parts for the vPTFE diaphragm

The vPTFE diaphragm (full PTFE diaphragm) is replaced in the same way as the standard diaphragm.



A fitted vPTFE diaphragm needs to be replaced once the dosing head screws have been loosened, as the pump will otherwise no longer be tight.

A spare parts kit contains:

- vPTFE diaphragms
- Suction valve
- Discharge valve
- Valve ball
- Sealing set
- Connector kit
- Seal

Pump type	2.0 diaphragm complete	2.0 spare parts kit PVM	2.0 spare parts kit PVN
1602 (1002)	1118690	1118461	1118460
1604 (1004)	1117351	1118462	1118454
0708	1117350	1118458	1118456
1009	1117350	1118458	1118456
0715	1117354	1118463	1118457
0414	1117354	1118463	1118457
0220	1117352	1118459	1118464
0424	1117352	1118459	1118464
0245	1117353	1118455	not available

14.2 Cleaning the diaphragm rupture indicator

After the diaphragm rupture indicator has been triggered, any residue of feed chemical may affect its function.

- After the diaphragm rupture indicator has been triggered, clean and test it.

1. ➤ First replace the liquid end diaphragm.
2. ➤ Unscrew the diaphragm rupture indicator using an AF 14 open-ended spanner.
3. ➤ Clean the diaphragm rupture indicator with suitable liquid - if possible using water (polysulphone material).
4. ➤ Test the connected diaphragm rupture indicator: fully immerse the tapered section at the front in water.
 - ⇒ The continuous display indicates a diaphragm rupture.

5. ▶ Thoroughly dry the diaphragm rupture indicator.
 - ⇒ The continuous display no longer indicates a diaphragm rupture.
6. ▶ Screw the clean and dry diaphragm rupture indicator into the hole until hand-tight and liquid-tight - without using tools.

14.3 Cleaning valves

INFORMATION: Refer to the exploded drawings of the pump when working on the unit.

INFORMATION: The order number of the appropriate spare parts kit can be found at the end of the 'Service' menu.

15 Troubleshooting

Safety information



WARNING!

Warning of hazardous feed chemical

Should a dangerous feed chemical be used: it may escape from the hydraulic components when working on the pump, material failure or incorrect handling of the pump.

- Take appropriate protective measures before working on the pump (e.g. safety glasses, safety gloves, ...). Adhere to the material safety data sheet for the feed chemical.
- Drain and flush the liquid end before working on the pump.



CAUTION!

Warning of feed chemical spraying around

Feed chemical may spray out of the hydraulic components if they are tampered with or opened due to pressure in the liquid end and adjacent parts of the system.

- Disconnect the pump from the mains power supply and ensure that it cannot be switched on again by unauthorised persons.
- Ensure that the system is at atmospheric pressure before commencing any work on hydraulic parts of the system.



WARNING!

Fire hazard with flammable media

Only with flammable media: They can be ignited by oxygen.

- The pump may not work if there is a mixture of feed chemical with oxygen in the liquid end. A specialist may need to take appropriate actions (using inert gas, ...).

15.1 Faults without a fault message

Faults without a fault message

Fault description	Cause	Remedy	Personnel
Pump does not prime in spite of full stroke motion and bleeding.	Minor crystalline deposits on the ball seat due to the valves drying out.	Take the suction hose out of the storage tank and thoroughly flush out the liquid end.	Technical personnel
	Serious crystalline deposits on the ball seat due to the valves drying out.	Dismantle the valves and clean them - refer to the "Repair" chapter.	Technical personnel
Fluid escapes from the backplate.	The screws in the dosing head are too loose.	Tighten the screws in the dosing head crosswise - refer to the "Repair" chapter for the tightening torque.	Instructed personnel







Fault description	Cause	Remedy	Personnel
Fluid escapes from the backplate.	The metering diaphragm is not leak-tight.	Replace the diaphragm - refer to the "Repair" chapter. If a diaphragm rupture has been indicated, clean the diaphragm rupture indicator - refer to the "Repair" chapter.	Technical personnel
Green LED display (operating indicator) not lighting up.	The wrong power supply or no power supply is connected.	The specified power supply as per the voltage specification can be found on the nameplate.	Electrician

15.2 Faults with error message



15.2.1 Fault messages on the LCD screen

In the event of a fault:

- the red LED display lights up.
- an identifier and a message appear on the LCD screen.
- the pump stops.

Fault description	Cause	Remedy	Personnel
No. 0: The identifier  appears followed by the message 'System error'.	System or EPROM error	Return the pump to ProMinent.	
No. 1: The identifier  appears followed by the message 'Input signal < 4 mA'.	The pump is in 'Analog' operating mode, a fault behaviour has been programmed in the 'Analog' menu and the control current has fallen below 4 mA.	Eliminate the cause of the low control current or Switch the programming of the fault behaviour to 'off' - see chapter "Set up"- "Settings"- "Operating mode"- "Analog".	Technical personnel
No. 2: The identifier  appears followed by the message 'Input signal > 20 mA'.	The pump is in 'Analog' operating mode, a fault behaviour has been programmed in the 'Analog' menu and the control current has risen above 20 mA.	Eliminate the cause of the high control current or Switch the programming of the fault behaviour to 'off' - see chapter "Set up"- "Settings"- "Operating mode"- "Analog".	Technical personnel
No. 3: The identifier  appears followed by the message 'Level error!'.	The fluid level in the storage tank has reached "Liquid level low 2nd stage".	Top up the storage tank.	Technical personnel
No. 4: The identifier  appears followed by the message 'Diaphragm rupture'.	The diaphragm is broken.	Replace the diaphragm and clean the diaphragm rupture indicator, refer to the "Repair" chapter.	Technical personnel
No. 5: The identifier  appears followed by the message 'Defective stroke met.'.	The metering monitor reported more defective strokes than was set in the 'Inputs/Outputs' menu.	Press the [Clickwheel]. Investigate and clear the cause.	Technical personnel
No. 6: The identifier  appears followed by the message 'Sensor error'.	Sensor faulty	Return the pump to ProMinent.	









Fault description	Cause	Remedy	Personnel
No. 7: The identifier  "Temperature" appears followed by the message 'Temperature' and the pump remains idle.	The ambient temperature is too high or too low.	Change the ambient temperature. The pump starts up automatically.	Technical personnel
	The temperature is too high.	Rectify the cause. The pump starts up automatically.	Technical personnel
No. 8: No identifier appears but the message 'Initialisation' appears.	Pump restart, initialisations incomplete.	Pump restart.	
No. 9: The identifier  appears followed by the message 'Solenoid not connected'.	The solenoid is not connected.	Return the pump to ProMinent.	
No. 10: The identifier  appears followed by the message 'Parameter wrong!'.	An incorrect parameter has been entered.	Correct the parameter.	Technical personnel
No. 11: The identifier  and the message 'Overload' appear.	The pump has detected too high a back pressure.	Rectify the cause and acknowledge the error.	Technical personnel
No. 12: The identifier  and the message 'Overload' appear.	The current is too high.	Rectify the cause and acknowledge the error.	Technical personnel
No. 13: The identifier  and the message 'Power supply' appear.	The power supply is too high or too low or not connected.	Rectify the cause.	Technical personnel
No. 14: The identifier  appears followed by the message 'Air in dosing head'.	Gas bubbles in the liquid end (leaks, gaseous medium, cavitation).	Bleed the liquid end and rectify the cause. Acknowledge the error.	Technical personnel
		Seal the system or slow the suction stroke.	
No. 15: The identifier  appears followed by the message 'Degassing unsuccessful'.	Automatic bleeding was unsuccessful	Rectify the causes and acknowledge the error.	Technical personnel
No. 16: The identifier  and the message 'Memory overflow' appear.	The stroke tank has overflowed.	Remedy the cause (such as too low a factor, too high a contact frequency ...), then: Press the [Clickwheel] (think of the consequences for the process!).	Technical personnel
No. 17: The identifier  and the message 'Control signal < Imin' appear.	The pump is in 'Analog'-'xx. side band' operating mode, a fault behaviour has been programmed in the 'Analog' menu and the control current has fallen below 4 mA (limit can be adjusted).	Eliminate the cause of the low control current or Switch the programming of the fault behaviour to 'off' - see chapter "Set up"-"Settings"-"Operating mode"-"Analog".	Technical personnel
No. 18: The identifier  and the message 'Control signal > Imax' appear.	The pump is in 'Analog'-'xx. side band' operating mode, a fault behaviour has been programmed in the 'Analog' menu and the control current has risen above 20 mA (limit can be adjusted).	Eliminate the cause of the high control current or Switch the programming of the fault behaviour to 'off' - see chapter "Set up"-"Settings"-"Operating mode"-"Analog".	Technical personnel

Fault description	Cause	Remedy	Personnel
No. 19: The identifier  appears followed by the message 'Negative pressure'.	The pump has detected too low a back pressure.	Rectify the cause and acknowledge the error.	Technical personnel
No. 20: The identifier  and the message 'Module missing' appear.	The optional module is missing.	Insert the optional module.	Technical personnel
	Communication between the optional module and pump electronics is not working.	Return the pump to ProMinent.	
No. 21: The identifier  and the message 'Module communication' appear.	The bus contact between the optional module and control room has been disconnected.	Rectify the cause (cable, control room ...)	Technical personnel

15.2.2 Warning messages on the LCD screen

In the event of a warning:

- the yellow LED display lights up!
- an identifier and a message appear on the LCD screen.

Fault description	Cause	Remedy	Personnel
No. 0: 'Level' and the identifier  appear.	The fluid level in the storage tank has reached "Liquid level low 1st stage".	Top up the storage tank.	Instructed personnel
No. 1: The identifier  appears followed by the message 'Diaphragm rupture'.	The diaphragm is broken.	Replace the diaphragm and clean the diaphragm rupture indicator, refer to the "Repair" chapter.	Technical personnel
No. 2: The identifier  appears followed by the message 'Defective stroke met.'.	The metering monitor reported more defective strokes than was set in the 'Inputs/Outputs' menu.	Press the <i>[Clickwheel]</i> . Investigate and clear the cause.	Technical personnel
No. 3: The identifier  and the message 'Invalid metering volume' appear.	The set metering volume in concentration mode cannot be metered.	Adjust the metering parameters.	Technical personnel
No. 4: The identifier  and the message 'Invalid parameter' appear.	A set parameter is invalid.	Adjust the parameter.	Technical personnel
No. 5: The identifier  and the message 'Fan warning' appear.	The fan is faulty or not connected.	Return the pump to ProMinent.	
No. 6: The identifier  appears followed by the message 'System warning'.	An internal system warning or an incorrect solenoid assignment has been detected.	Return the pump to ProMinent.	
No. 7: The identifier  appears followed by the message 'Air in dosinghead'.	Gas bubbles in the liquid end (leaks, gaseous medium, ...)	Bleed the liquid end and rectify the cause. Seal the system or slow the suction stroke.	Technical personnel

Fault description	Cause	Remedy	Personnel
No. 8: The identifier P+ and the message 'Overload' appear.	The pump has detected too high a back pressure.	Rectify the cause.	Technical personnel
No. 9: The identifier X and the message 'Dos. capacity too low' appear.	The pump cannot meter the capacity it has calculated from the settings.	Modify the settings.	Technical personnel
No. 10: The identifier P- and the message 'Negative pressure' appear.	The pump has detected too low a back pressure.	Rectify the cause.	Technical personnel
No. 11: The identifier C appears followed by the message 'Cavitation'.	Cavitation in the liquid end.	Adjust the metering parameters.	Technical personnel

15.2.3 All other faults

Please contact the responsible ProMinent branch or representative!

15.3 Log book

15.3.1 Fault messages in the log book



For more information on the 'ERROR' messages - refer to the chapter "Fault messages on the LCD screen".

Tab. 22: Errors

Log book no.	Description	Acknowledge?
0	System, EEPROM error *	X
1	The pump is in 'Analog' operating mode, a fault behaviour has been programmed in the 'Analog' menu and the control current has risen above 20 mA.	-
2	The pump is in 'Analog' operating mode, a fault behaviour has been programmed in the 'Analog' menu and the control current has fallen below 4 mA.	-
3	The fluid level in the storage tank has reached "Liquid level low 2nd stage".	-
4	The diaphragm is broken.	-
5	The metering monitor reports more defective strokes than were set in the 'Inputs/Outputs' menu.	X
6	Fault on the sensor for the stroke length.*	-
7	The ambient temperature is too high or too low.	-
8	Fault during initialisation.	-
9	Fault on the solenoid. *	-
10	Fault with the stroke parameters.	-
11	The pump has detected too high a back pressure.	X

Log book no.	Description	Acknowledge?
12	The power supply is too high.	X
13	The power supply is too low or not connected.	-
14	Gas bubbles in the liquid end (leaks, gaseous medium, cavitation).	X
15	Fault during bleeding.	X
16	The stroke tank has overflowed.	X
17	The pump is in 'Analog'-"xx. side band" operating mode, a fault behaviour has been programmed in the 'Analog' menu and the control current has fallen below 4 mA.	-
18	The pump is in 'Analog'-"xx. side band" operating mode, a fault behaviour has been programmed in the 'Analog' menu and the control current has risen above 20 mA.	-
19	The pump has detected too low a back pressure.	X
20	No connection between the optional module and the bus.	-
21	An optional module is no longer found.	-

* Please get in touch with the ProMinent head office should this fault occur.

15.3.2 Warning messages in the log book





For more information on the 'WARNING' messages - refer to the chapter "Warning messages on the LCD screen".

Tab. 23: Warnings

Log book no.	Description
0	The fluid level in the storage tank has reached "Liquid level low 1st stage".
1	The diaphragm is broken.
2	The metering monitor reports more defective strokes than were set in the 'Inputs/Outputs' menu.
3	The metering volume cannot be metered.
4	A set parameter is invalid.
5	The fan is faulty or not connected.
6	An internal system warning or an incorrect solenoid assignment has been detected.
7	Gas bubbles in the liquid end (leaks, gaseous medium, cavitation).
8	The pump has detected too high a back pressure.
9	The pump cannot meter the capacity it has calculated from the settings.
10	The pump has detected too low a back pressure.
11	Cavitation in the liquid end.

15.3.3 Event messages in the log book

Tab. 24: Events

Log book no.	Description
0	Head change is active – dongle was inserted.
1	Parameter menu called up – dongle was inserted.
2	Air gap measured – dongle was inserted.
3	Too high current was detected but no fault message generated.
4	The controller data was not plausible.
5	Automatic bleed was active.
6	The pump status has changed.
7	The pump was reset to factory settings.
8	The pump was calibrated.
9	 [START/STOP] was pressed.
10	 [Priming] was pressed.
11	The [Clickwheel] was pressed.
12	The diaphragm was replaced.
13	The timer performed an action.
14	A relay has triggered.
15	Solenoid identification was performed.
16	CRC error has been detected in the EEPROM data. <i>Log book:</i> [hh ll 00 00] hh – MSB address ll – LSB address [00 00 rr ss] ss – Struct rr – Result
17	Overloading has been detected. <i>Log book:</i> [00 PP zz ii] PP – Solenoid power [W] zz – Uzk [V] ii – Solenoid current [* 100 mA]
18	The metering volume cannot be metered. In 'Contact' operating mode, e.g. by too fast a contact sequence.
19	The pump has been booted and is operational.

15.3.4 Log book entry - Detailed view

Press the [Clickwheel] to obtain more information about a log book entry.

Tab. 25: Information on the detailed view

Line	Information
1	Date/time
2	Type of entry (fault, warning ...)
3	Total operating time, total number of strokes
4	Switching-on duration, stroke rate since switching on
5	Room temperature, status information on the error (for developers)

16 Decommissioning and disposal

Decommissioning

**WARNING!****Danger from chemical residue**

There is normally chemical residue in the liquid end and on the housing after operation. This chemical residue could be hazardous to people.

- It is essential that the safety information in the "Storage, transport and unpacking" chapter is read before shipping or transport.
- Thoroughly clean the liquid end and the housing of chemicals and dirt. Pay attention to the material safety data sheet for the feed chemical.

**WARNING!****Warning of hazardous feed chemical**

Should a dangerous feed chemical be used: it may escape from the hydraulic components when working on the pump, material failure or incorrect handling of the pump.

- Take appropriate protective measures before working on the pump (e.g. safety glasses, safety gloves, ...). Adhere to the material safety data sheet for the feed chemical.
- Drain and flush the liquid end before working on the pump.

**WARNING!****Fire hazard with flammable media**

Only with flammable media: They can be ignited by oxygen.

- The pump may not work if there is a mixture of feed chemical with oxygen in the liquid end. A specialist may need to take appropriate actions (using inert gas, ...).

INFORMATION: Take into account the information in the "Storage, transport and unpacking" chapter if the system is temporarily decommissioned.

Draining the liquid end

1. ➤ Disconnect the pump from the mains/power supply.
2. ➤ Depressurise the pump.
3. ➤ Drain the liquid end by turning the pump upside down and allowing the feed chemical to run out.
4. ➤ Flush the liquid end and the dosing head with a suitable medium.

Disposal



WARNING!

Eye injury from compression spring

A compression spring is fitted in the pump in the drive magnet, which could cause eye injuries when opened.

- Do not dismantle the pump when disposing of it or put in place appropriate protective measures.



CAUTION!

Environmental hazard due to electronic waste

There are components in the pump, which can have a toxic effect on the environment.

- Note the pertinent regulations currently applicable in your country.

Sign indicating EU collection system



In accordance with the European Directive 2012/19/EU on waste electrical and electronic equipment, this device features the symbol showing a waste bin with a line through it. The device must not be disposed of along with domestic waste. To return the device, use the return and collection systems available and observe the local legal requirements.

17 Technical data

17.1 Performance data

Tab. 26: At 200 strokes/minute and 100% stroke length

Type	Pump capacity			Connector size outer Ø x inner Ø	Suction lift ¹	Priming lift ²	Max. priming pressure on the suction side ^{5, 6}
	bar	l/h	ml/stroke				
2002	20	2.05	0.17	6x3	6.0	2.5	10
1602	16	2.3	0.20	6x4	6.0	2.5	8
1604	16	3.6	0.30	6x4 ⁴	5.0	3.0	8
0708	7	7.6	0.63	8x5 ⁴	4.0	2.0	3.5
0414	4	13.5	1.13	8x5 ^{4, ****}	3.0	2.5	2
0220	2	19.7	1.64	12x9 ⁴	2.0	2.0	1
2504	25	3.8	0.32	8x4 ^{4, ***}	4.0	3.0	12.5
1009	10	9.0	0.75	8x5 ⁴	3.0	3.0	5
0715	7	14.5	1.21	8x5 ^{4, ****}	3.0	3.0	3.5
0424	4	24.0	2.00	12x9 ⁴	3.0	3.0	2
0245	2	45.0	3.70	12x9	2.0	2.0	1
Metering pumps with self-degassing dosing head SER^{3****}							
1602	10	1.5*	0.13	6x4	1.8	1.2	5
1604	10	2.2*	0.18	6x4	1.8	1.2	5
0708	7	5.6	0.47	8x5	1.8	1.0	3.5
0414	4	12.2	1.01	8x5	1.8	1.4	2
0220	2	18.0	1.50	12x9	1.8	1.7	1
1009	10	6.6	0.55	8x5	1.8	1.0	5
0715	7	13.0	1.08	8x5	1.8	1.4	3.5
0424	4	22.0	1.83	12x9	1.8	1.7	2
0245	2	40.0	3.33	12x9	1.8	1.0	1
Metering pumps with self-degassing dosing head SEK³							
1602	10	1.3*	0.11	6x4	2.1	-	5
1604	10	2.4*	0.21	6x4	2.7	-	5
0708	7	6.8	0.57	8x5	2.0	-	3.5
0414	4	12.0	1.00	8x5	2.0	-	2
0220	2	18.0	1.50	12x9	2.0	-	1

⁵ The pressure on the discharge side needs to be at least 1.5 bar higher than the pressure on the suction side. We therefore recommend installing a back pressure valve on the discharge side to adjust the increased pressure. This will avoid excess pumping.

⁶ If the pump is fitted with an SER head and priming pressure is being applied, then the pump may only be operated in Automatic OFF mode.

Type	Pump capacity			Connector size outer Ø x inner Ø	Suction lift ¹	Priming lift ²	Max. priming pressure on the suction side ^{5,6}
	bar	l/h	ml/stroke				
1009	10	8.0	0.67	8x5	3.0	-	5
0715	7	13.5	1.12	8x5	2.5	-	3.5
0424	4	20.0	1.67	12x9	2.5	-	2

⁵ The pressure on the discharge side needs to be at least 1.5 bar higher than the pressure on the suction side. We therefore recommend installing a back pressure valve on the discharge side to adjust the increased pressure. This will avoid excess pumping.

⁶ If the pump is fitted with an SER head and priming pressure is being applied, then the pump may only be operated in Automatic OFF mode.

- * - The capacity can significantly fall at pressures above the nominal pressure.
- *** - with stainless steel design 6 mm connector width
- **** - with stainless steel design 12 mm connector width
- ***** - The SER valve is only approved up to a pressure of 10 bar. We recommend operating a pump with a SER valve of between 1 ... 7 bar.
- 1 - Suction lift with a filled suction line and filled liquid end. With self-degassing dosing head with air in the suction line.
- 2 - Priming lifts with clean and moist valves. Priming lift at 100% stroke length and free drainage or opened vent valve.
- 3 - The given performance data represents guaranteed minimum values calculated using water as the medium at room temperature. The bypass connection with a self-degassing dosing head SEK is 6x4 mm.
- 4 - These pump types are also available with dosing heads for higher-viscosity media (HV). The pump types have a 10 ... 20% lower capacity and are not self-priming.

All data is calculated with water at 20 °C.

17.1.1 Performance data with vPTFE diaphragm

Tab. 27: gamma/ X with 200 strokes/minute and 100% stroke length

Type ... PVT	Minimum pump capacity * at maximum back pressure			Connector size outer Ø x inner Ø	Suction lift**	Priming lift***	Max. priming pressure on the suction side
	bar	l/h	ml/stroke				
gamma X							
1602 ...	10	2.04	0.17	6x4	5	2	5.5
1604 ...	10	3.24	0.28	6x4	5	2	3

Type ... PVT	Minimum pump capacity * at maximum back pressure			Connector size outer Ø x inner Ø	Suction lift**	Priming lift***	Max. pri- ming pres- sure on the suction side
	bar	l/h	ml/stroke				
0708 ...	7	7.6	0.66	8x5	4	2	2
1009 ...	10	9.0	0.76	8x5	3	2	2
0414 ...	4	11.52	0.94	8x5	3	2	1.5
0715 ...	7	10.2	1.03	8x5	3	2	1.5
0220 ...	2	16.56	1.48	12x9	2	2	1
0424 ...	4	19.8	1.79	12x9	3	2.5	1
0245 ...	2	35.64	3.1	12x9	2	2	0.8

* The stated performance data represents minimum values calculated using water as the medium at 20 °C.

** Suction lift with a filled suction line and filled liquid end.

*** Priming lifts with clean and moist valves. Priming lift at 100% stroke length and free drainage or opened vent valve.

17.2 Accuracy

17.2.1 Standard Liquid End

Data	Value	Unit
Capacity range of the series	-5 ... +10	% *
Reproducibility	±2	% **

* - at max. stroke length and max. operating pressure for all material versions

** - at constant conditions and min. 30 % stroke length

17.2.2 Self-Bleeding Liquid End

As the self-bleeding liquid end is used with outgassing media and when operating with air bubbles, no dosing accuracy or reproducibility can be provided.

The recommended minimum stroke length with self-bleeding dosing pumps is 50 %.

17.3 Viscosity

Tab. 28: The liquid ends are suitable for the following viscosity ranges:

Design	Viscosity in mPas
Standard	0 ... 200
With valve springs	201 ... 500
With HV head	501 ... 3000*
Self-degassing (SEK)	0 ... 50

* Even significantly higher with correctly adjusted installation. Contact Technical Support in Heidelberg.

Tab. 29: General information on selection according to viscosity.

Viscosity in mPas	Options	Stroke rate (strokes/minute)
0 ... 200	No specific options required	Any stroke rate.
201 ... 500	Valves fitted with springs	HV1 mode: Stroke rate max. 160 strokes/minute.
501 ... 1000	Valves fitted with springs. HV head recommended. A positive flow is required. Stroke length >75%.	HV 2 mode: Stroke rate max. 120 strokes/minute.
1001 ... 3000	Select an HV head. Valves fitted with springs. A positive flow is required. Stroke length >75%.	HV 3 mode: Stroke rate max. 80 strokes/minute.
> 3000	Contact Customer Service to select a suitable pump.	

17.4 Material specifications

Standard liquid ends

Design	Dosing head	Valves	Seals	Balls
PPT	Polypropylene	PVDF	PTFE	Ceramic
NPT	Clear acrylic	PVDF	PTFE	Ceramic
PVT	PVDF	PVDF	PTFE	Ceramic
PPE	Polypropylene	EPDM	EPDM	Ceramic
PPB	Polypropylene	FKM	FKM	Ceramic
NPE	Clear acrylic	EPDM	EPDM	Ceramic
NPB	Clear acrylic	FKM	FKM	Ceramic
TTT	PTFE	PTFE	PTFE	Ceramic
SST	Stainless steel 1.4404	Stainless steel 1.4404/1.4571	PTFE	Ceramic

Diaphragm: with PTFE coating.

FKM = fluorine rubber.

Drive unit

Housing parts: Polyphenylene ether (PPE with fibreglass)

17.5 Electrical data

Design: 100 ... 230 V ±10%, 50/60 Hz, gamma/ X GMXa

Parameter	M70	M85
Nominal power**, approx.	25 W	30 W
Current I eff	0.25 ... 0.10 A	0.30 ... 0.12 A
Switch on peak current (for 3 ...5 ms)	20 A	20 A
Fuse*	2.5 slow blow	2.5 slow blow

** With relay closed: The nominal power rises by 1 watt.

* Fuses must have VDE, UL and CSA certification. e.g. type 19195 manufactured by Wickmann in compliance with IEC Publ. 127 - 2/3

17.6 Temperatures

Pump, complete

Data	Value	Unit
Storage and transport temperature:	-20 ... +50	°C
Ambient temperature in operation (power end/drive and control):	-10 ... +45	°C
Medium temperature:	-10 °C ... see following table	

Liquid ends

Material version	Long term	Temporary *
PP	50 °C	100 °C
NP	45 °C	60 °C
PV	50 °C	120 °C
SS	50 °C	120 °C
TT	50 °C	120 °C

* Max. temp., for 15 min. at max. 2 bar, depending on the ambient temperature

17.7 Climate

Data	Value	Unit
Maximum air humidity*:	95	% relative humidity

* Non-condensing

Test: Humid heat, cyclical,

in accordance with EN 680068-2-30: 2005

17.8 Altitude of site

Data	Value	Unit
Altitude of site , max.:	2000	m above NHN

17.9 Degree of protection and safety requirements

17.9.1 Degree of protection

Protection against contact and moisture: The pump is designed in accordance with: IP 66 (EN 60529) and NEMA-4X/indoor (NEMA 250)

17.9.2 Safety requirements

Degree of protection: 1 - Mains connection with protective earth conductor

17.9.3 Degree of pollution

Degree of pollution: 2

17.10 Compatibility

Compatibility to the gamma/ L product range is guaranteed with the following components:

- Control cable Beta 5-wire for the "External" function.
- Control cable gamma/Vario 2-, 4- and 5-wire for the "External" function
- Level switch 2-stage (gamma / Beta / delta)
- Dosing line cross-sections for gamma / Beta
- Standard connector kit for gamma / Beta
- Wall brackets for gamma / Beta
- Dosing tanks and fixing plates
- Distance between suction and pressure connector
- Distance between the connectors and the pump fixing holes
- Distance between the pump fixing holes

- Identical use of accessories, such as back pressure valves, multifunctional valves and flushing assembly
- Compatibility of resistance by the equivalence of the material used for the liquid ends

Compatibility to the gamma/ L product range is not guaranteed for the following points:

- External dimensions of the pump
- Distance between the support surface for the mounting foot and the centre of the dosing head
- Metering monitor

17.11 Shipping weight

Shipping weight of gamma/ X types - in kg

Material	Types	
	2002, 1602, 1604, 0708, 0414, 0220	2504, 1009, 0715, 0424, 0245
PP, NP, PV, TT	3.6 .. 3.7	4.9 ... 5.2
SS	4.1 ... 5.0	5.5 ... 7.0

17.12 Sound pressure level

Sound pressure level

Sound pressure level $L_{pA} < 70$ dB according to EN ISO 20361 at maximum stroke length, maximum stroke rate, maximum back pressure (water)

18 Exploded drawings and ordering information

18.1 Exploded drawings

Liquid end gamma/ X 1602 - 1604
PP_2

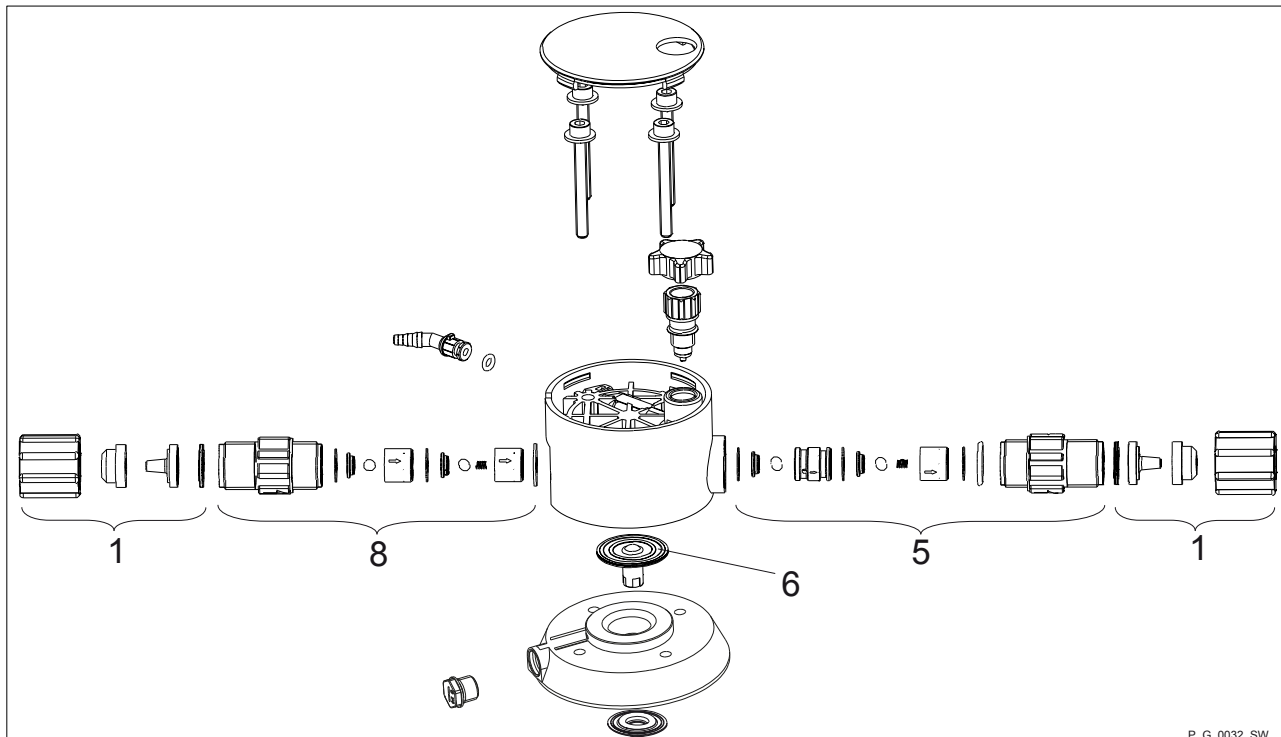

Fig. 41

Tab. 30: Spare parts for liquid end gamma/ X 1602 - 1604 PP_2

Pos.	Description
1	Connector kit
5	Discharge valve
6	Diaphragm
8	Suction valve

Liquid end gamma/ X 1602 PP_2

	PPE2	PPB2	PPT2
Liquid end	1050931	1050900	1050942
Spare parts kit	1001646	1001654	1023109
Diaphragm	1000246	1000246	1000246

Liquid end gamma/ X 1604 PP_2

	PPE2	PPB2	PPT2
Liquid end	1050932	1050901	1050943
Spare parts kit	1039989	1039987	1035332
Diaphragm	1034612	1034612	1034612

Liquid end gamma/ X 0708 (1009) - 0220 (0424) PP_2

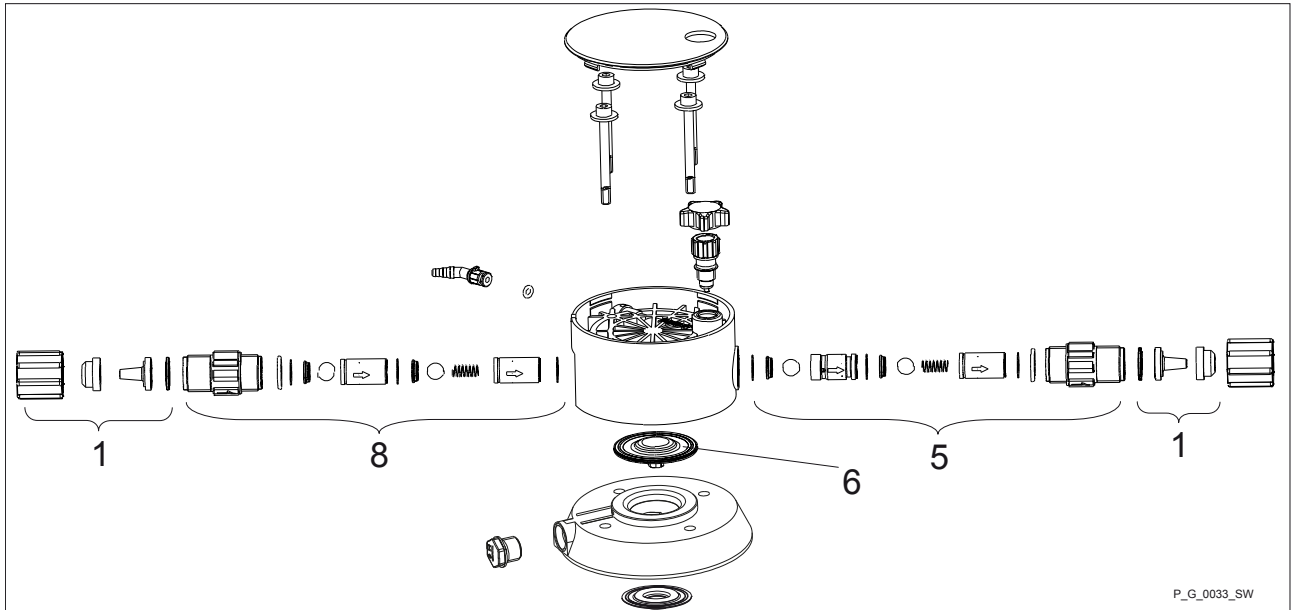

Fig. 42

Tab. 31: Spare parts for liquid end gamma/ X 0708 (1009) - 0220 (0424) PP_2

Pos.	Description
1	Connector kit
5	Discharge valve
6	Diaphragm
8	Suction valve

Liquid end gamma/ X 0708 (1009) PP_2

	PPE2	PPB2	PPT2
Liquid end	1050933	1050902	1050944
Spare parts kit	1001648	1001656	1023111
Diaphragm	1000248	1000248	1000248

Liquid end gamma/ X 0414 (0715) PP_2

	PPE2	PPB2	PPT2
Liquid end	1050934	1050903	1050945
Spare parts kit	1001649	1001657	1023112
Diaphragm	1000249	1000249	1000249

Liquid end gamma/ X 0220 (0424) PP_2

	PPE2	PPB2	PPT2
Liquid end	1050935	1050924	1050946
Spare parts kit	1051096	1051085	1051129
Diaphragm	1045456	1045456	1045456

Liquid end gamma/ X 0245 PP_0

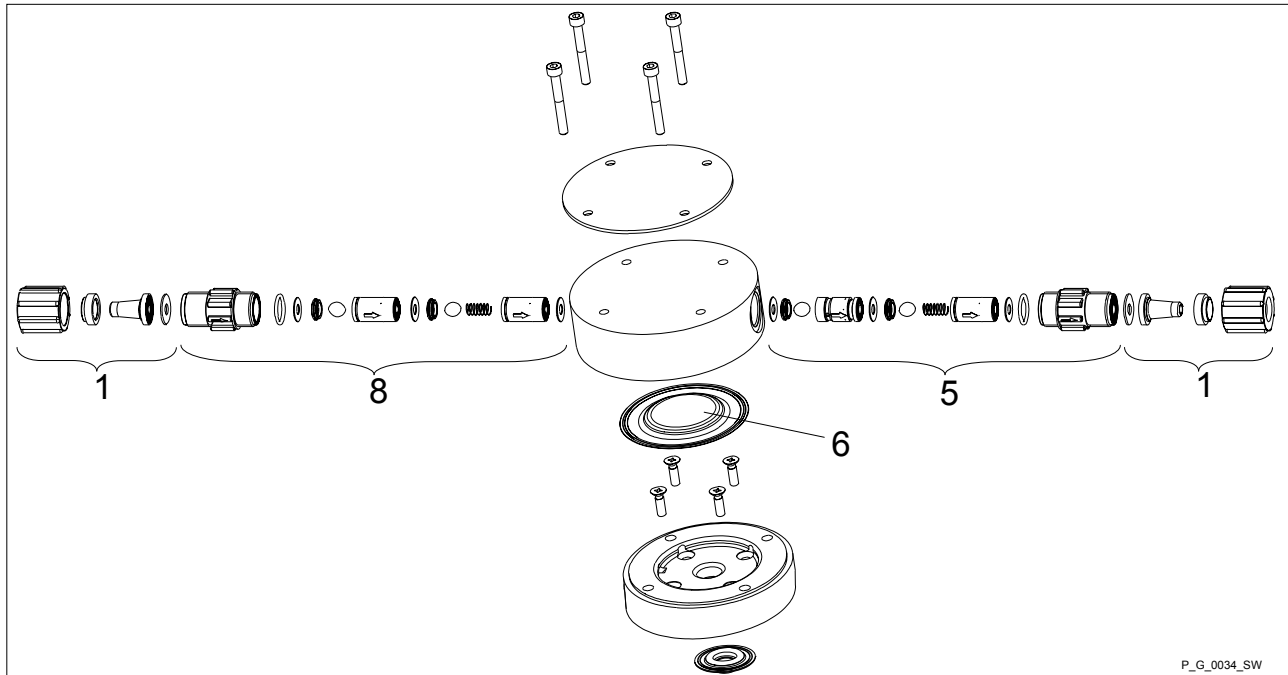

Fig. 43

Tab. 32: Spare parts kit for liquid end gamma/ X 0245 PP_0

Pos.	Description
1	Connector kit
5	Discharge valve
6	Diaphragm
8	Suction valve

Liquid end gamma/ X 0245

	PPE0	PPB0	PPT0
Liquid end	1050936	1050925	1050947
Spare parts kit	1051097	1051086	1051130
Diaphragm	1045443	1045443	1045443

Liquid end gamma/ X 1602 - 2504
NP_0 and NP_2

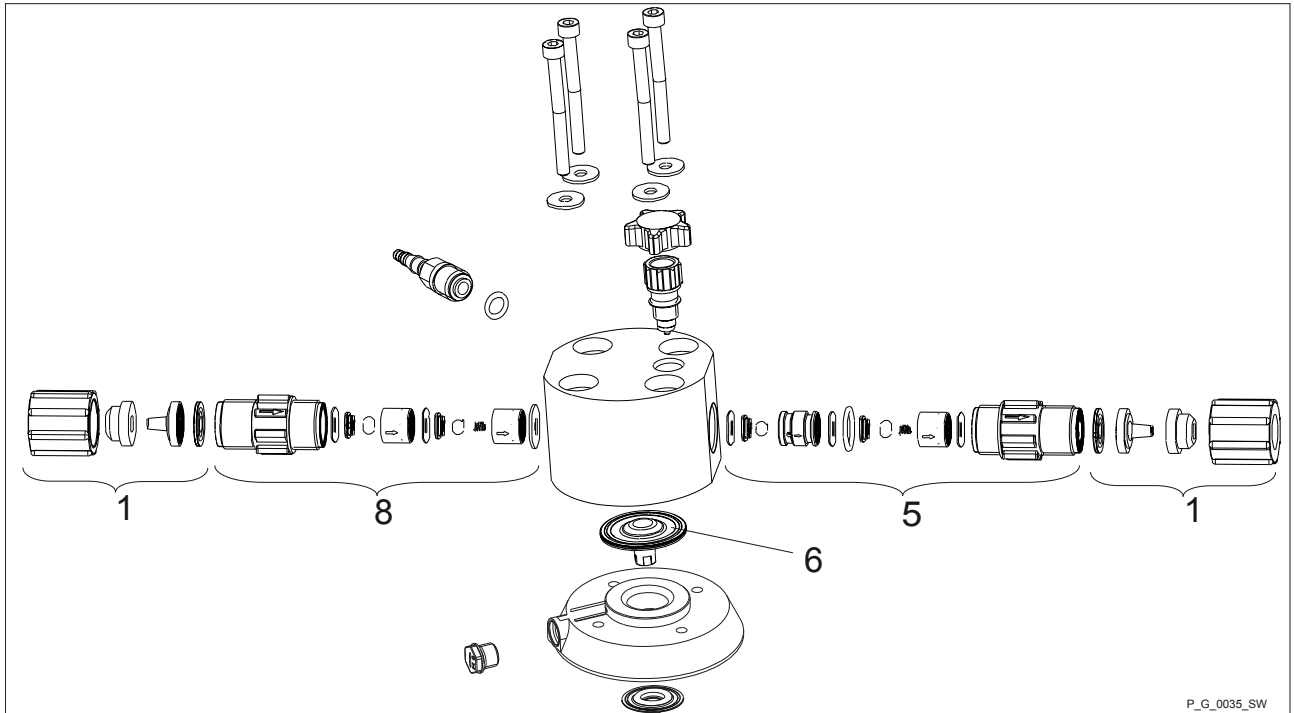

Fig. 44

Tab. 33: Spare parts for liquid end gamma/ X 1602 - 2504 NP NP_0 and NP_2

Pos.	Description
1	Connector kit
5	Discharge valve
6	Diaphragm
8	Suction valve

Liquid end gamma/ X 2002

	NPE_	NPB_	NPT_
Liquid end with bleed valve, _2	1050965	1050948	1050982
Liquid end without bleed valve, _0	1050971	1050954	1050988
Spare parts kit	1001715	1001723	1023109
Diaphragm	1000246	1000246	1000246

Exploded drawings and ordering information

Liquid end gamma/ X 1602

	NPE_	NPB_	NPT_
Liquid end with bleed valve, _2	1051073	1051071	1051087
Liquid end without bleed valve, _0	1051084	1051072	1051088
Spare parts kit	1001715	1001723	1023109
Diaphragm	1000246	1000246	1000246

Liquid end gamma/ X 2504

	NPE_	NPB_	NPT_
Liquid end with bleed valve, _2	1051175	1051163	1051179
Liquid end without bleed valve, _0	1051176	1051174	1051180
Spare parts kit	1039988	1039986	1035332
Diaphragm	1034612	1034612	1034612

Liquid end gamma/ X 1604

	NPE_	NPB_	NPT_
Liquid end with bleed valve, _2	1050966	1050949	1050983
Liquid end without bleed valve, _0	1050972	1050955	1050989
Spare parts kit	1039988	1039986	1035332
Diaphragm	1034612	1034612	1034612

Liquid end gamma/ X 0708 (1009) - 0220 (0424) NP_0 and NP_2

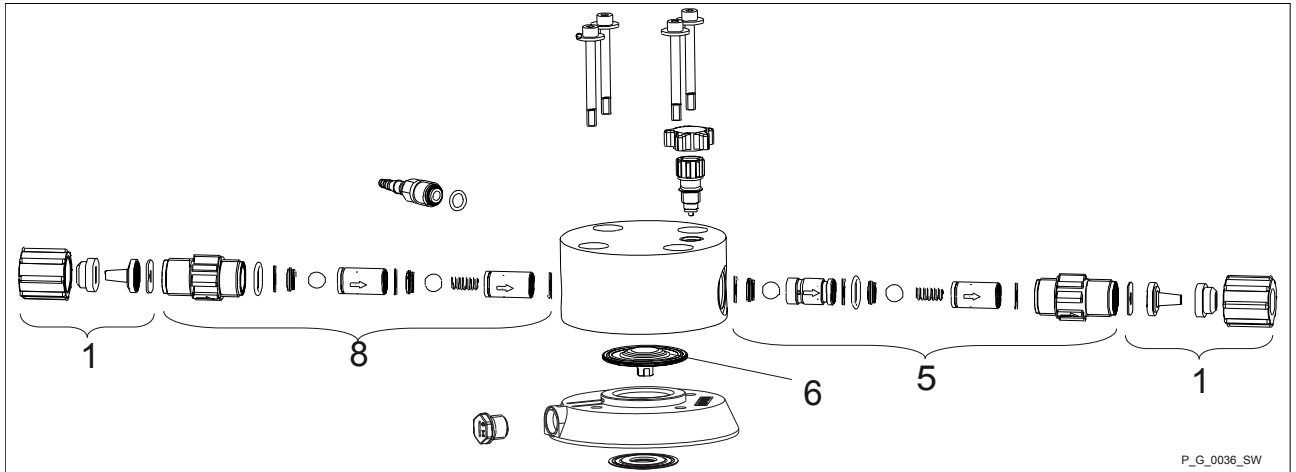

Fig. 45

Tab. 34: Spare parts for liquid end gamma/ X 0708 (1009) - 0220 (0424) NP_0 and NP_2

Pos.	Description
1	Connector kit
5	Discharge valve
6	Diaphragm
8	Suction valve

Liquid end gamma/ X 0708 (1009)

	NPE_	NPB_	NPT_
Liquid end with bleed valve, _2	1050967	1050950	1050984
Liquid end without bleed valve, _0	1050973	1050956	1050990
Spare parts kit	1001717	1001725	1023111
Diaphragm	1000248	1000248	1000248

Liquid end gamma/ X 0414 (0715)

	NPE_	NPB_	NPT_
Liquid end with bleed valve, _2	1050968	1050951	1050985
Liquid end without bleed valve, _0	1050974	1050957	1050991
Spare parts kit	1001718	1001726	1023112
Diaphragm	1000249	1000249	1000249

Liquid end gamma/ X 0220 (0424)

	NPE_	NPB_	NPT_
Liquid end with bleed valve, _2	1050969	1050952	1050986
Liquid end without bleed valve, _0	1050975	1050958	1050992
Spare parts kit	1051118	1051107	1051129
Diaphragm	1045456	1045456	1045456

Liquid end gamma/ X 0245 NP_0 and NP_2

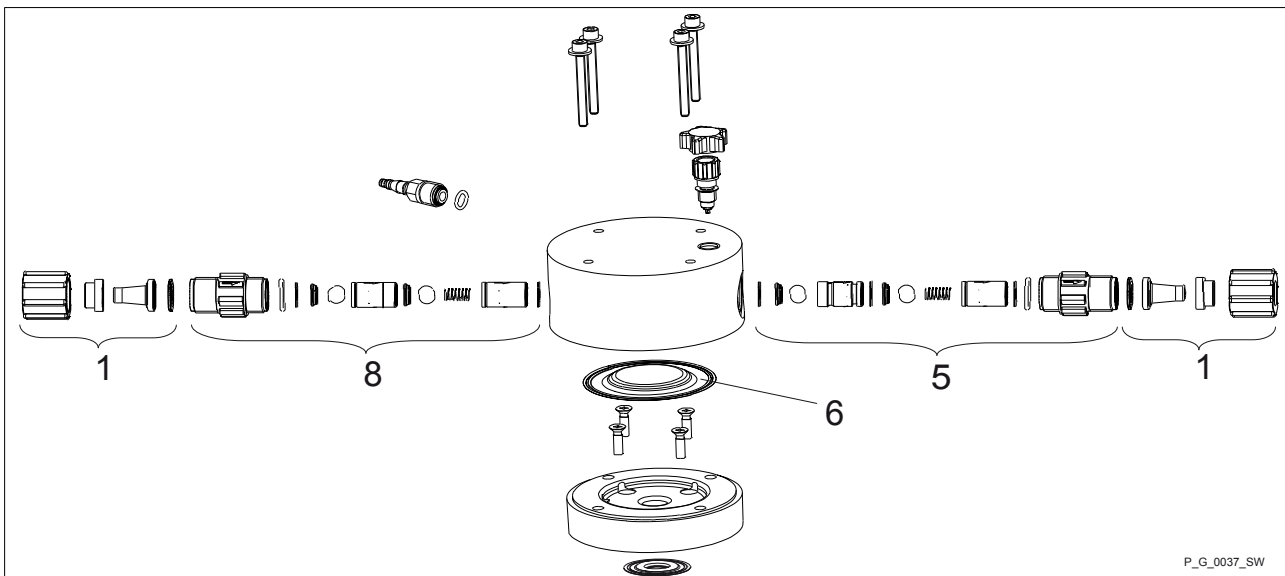

Fig. 46

Tab. 35: Spare parts for liquid end gamma/ X 0245 NPT0 and NPT2

Pos.	Description
1	Connector kit
5	Discharge valve
6	Diaphragm
8	Suction valve

Liquid end gamma/ X 0245

	NPE_	NPB_	NPT_
Liquid end with bleed valve, _2	1050970	1050953	1050987
Liquid end without bleed valve, _0	1050976	1050959	1050993
Spare parts kit	1051119	1051108	1051130
Diaphragm	1045443	1045443	1045443

Liquid end gamma/ X 1602 - 1604
PVT2

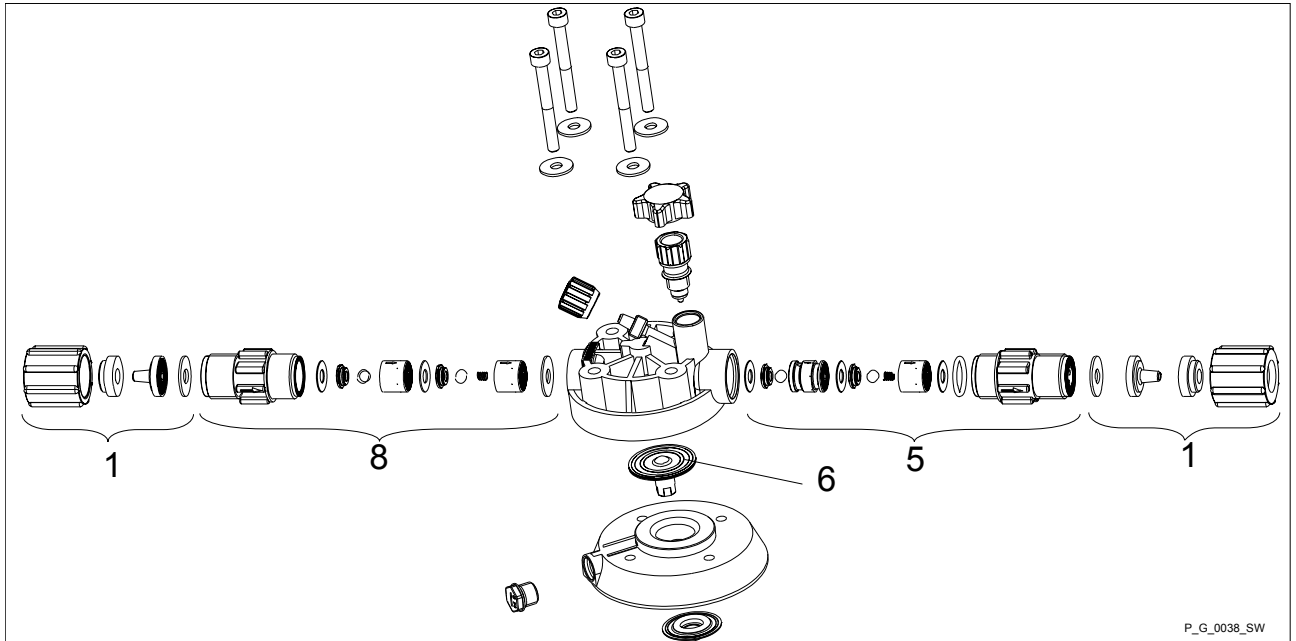

Fig. 47

Tab. 36: Spare parts for liquid end gamma/ X 1602 - 1604 PVT2

Pos.	Description
1	Connector kit
5	Discharge valve
6	Diaphragm
8	Suction valve

Liquid end gamma/ X 1602

	PVT2
Liquid end	1050994
Spare parts kit	1023109
Diaphragm	1000246

Liquid end gamma/ X 1604

	PVT2
Liquid end	1050995
Spare parts kit	1035332
Diaphragm	1034612

Liquid end gamma/ X 0708 (1009) - 0220 (0424) PVT2

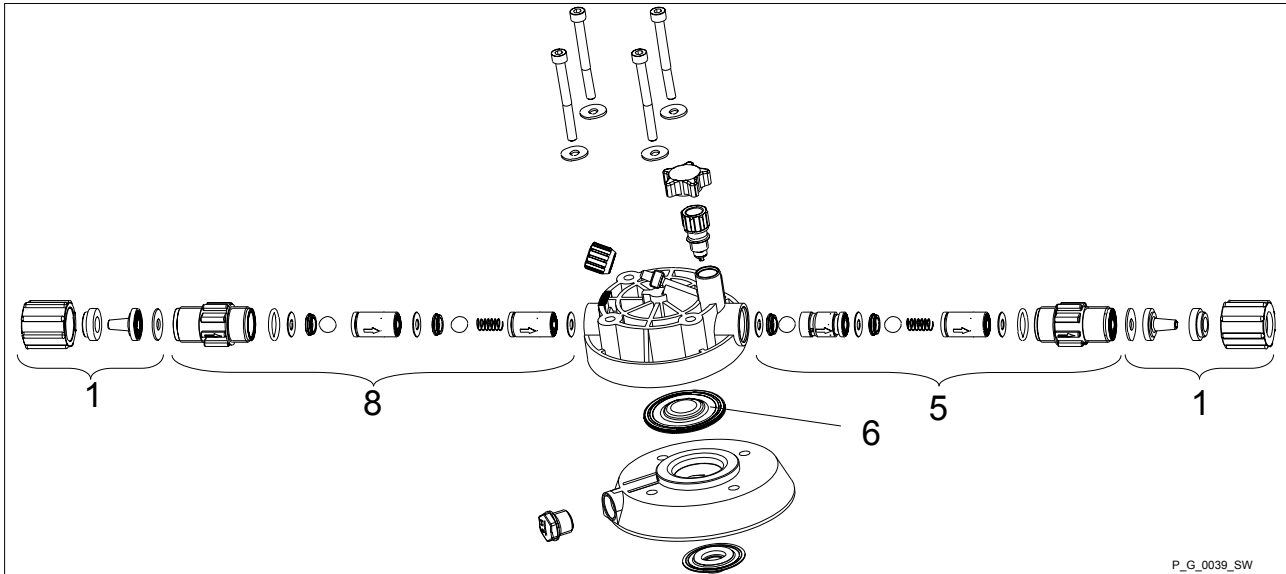

Fig. 48

Tab. 37: Spare parts kit for liquid end gamma/ X 0708 (1009) - 0220 (0424) PVT2

Pos.	Description
1	Connector kit
5	Discharge valve
6	Diaphragm
8	Suction valve

Liquid end gamma/ X 0708 (1009)

	PVT2
Liquid end	1050996
Spare parts kit	1023111
Diaphragm	1000248

Liquid end gamma/ X 0414 (0715)

	PVT2
Liquid end	1050997
Spare parts kit	1023112
Diaphragm	1000249

Liquid end gamma/ X 0220 (0424)

	PVT2
Liquid end	1050998
Spare parts kit	1051129
Diaphragm	1045456

Liquid end gamma/ X 0245 PVT0

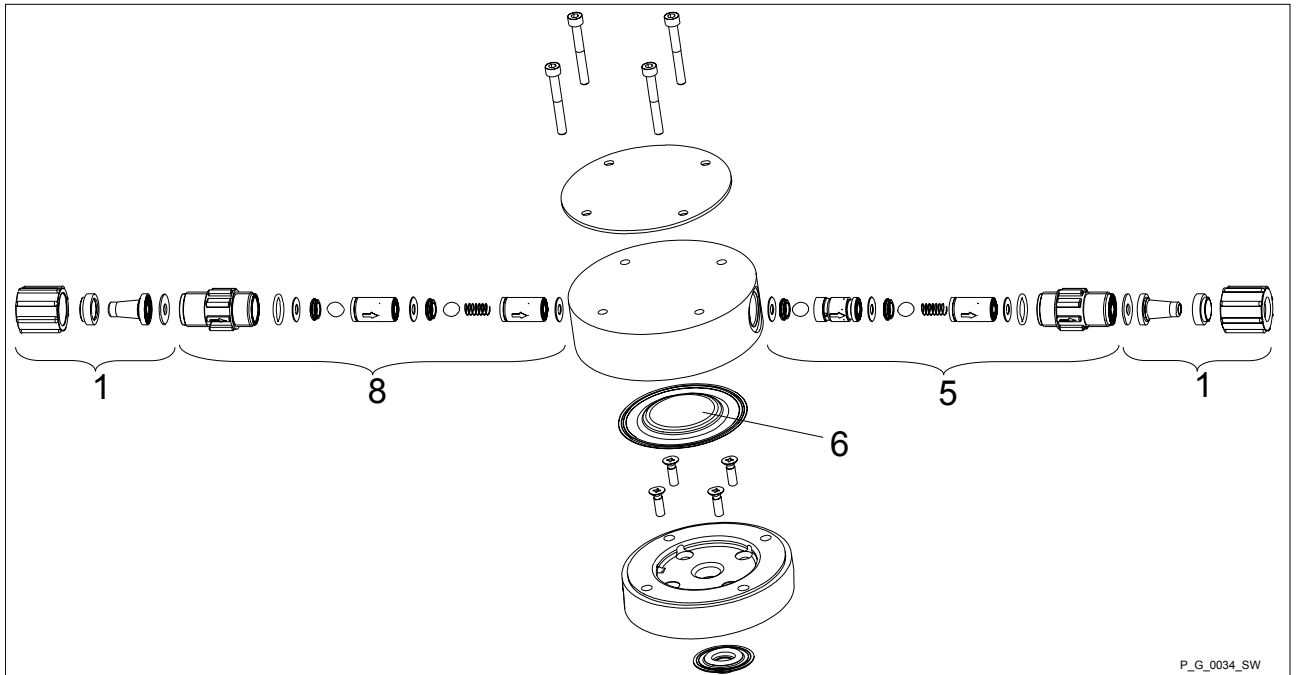

Fig. 49

Tab. 38: Spare parts kit for liquid end gamma/ X 0245 PVT0

Pos.	Description
1	Connector kit
5	Discharge valve
6	Diaphragm
8	Suction valve

Liquid end gamma/ X 0245

	PVT0
Liquid end	1050999
Spare parts kit	1051130
Diaphragm	1045443

Liquid end gamma/ X 1604 - 0220
(0424) PV_4

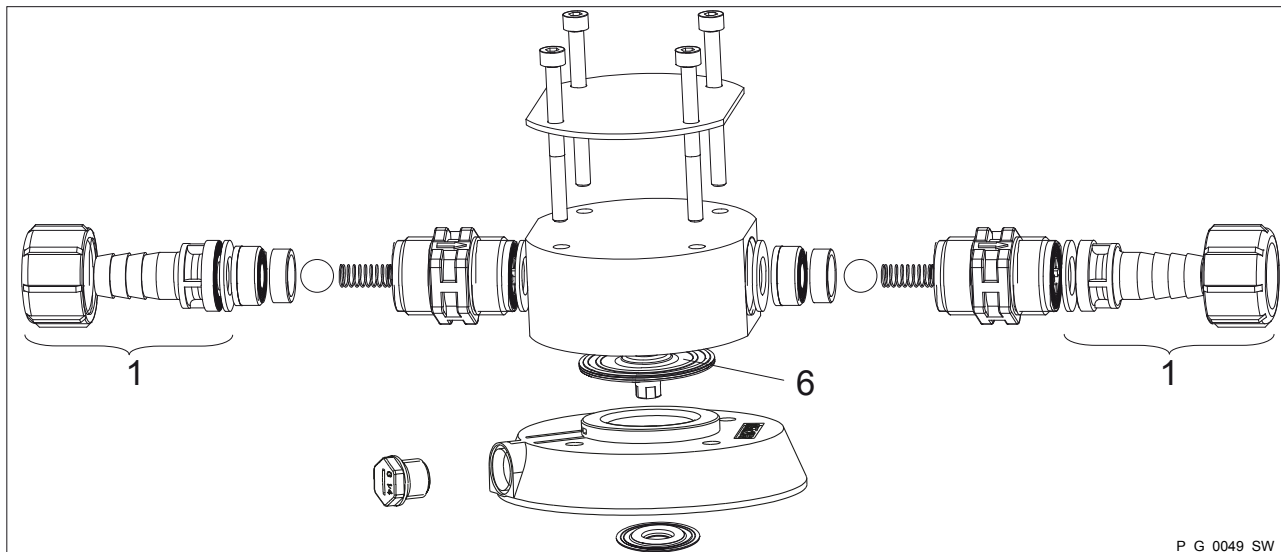

Fig. 50

Tab. 39: Spare parts kit for liquid end gamma/ X 1604 - 0220 (0424) PV_4

Pos.	Description
1	Connector kit with hose nozzle
6	Diaphragm

Liquid end gamma/ X 1604

	PV_4
Liquid end	1051000
Spare parts kit	1035342
Diaphragm	1034612

Liquid end gamma/ X 0708 (1009)

	PV_4
Liquid end	1051001
Spare parts kit	1019067
Diaphragm	1000248

Liquid end gamma/ X 0414 (0715)

	PV_4
Liquid end	1051002
Spare parts kit	1019069
Diaphragm	1000249

Liquid end gamma/ X 0220 (0424)

	PV_4
Liquid end	1051003
Spare parts kit	1051134
Diaphragm	1045456

Liquid end gamma/ X 1602 - 1604
TTT0

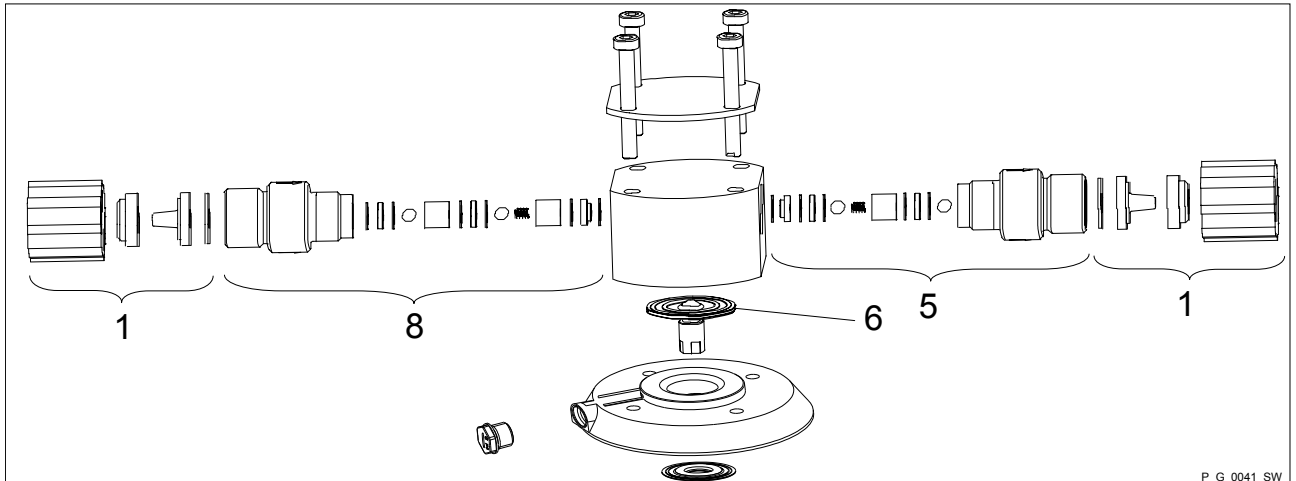

Fig. 51

Tab. 40: Spare parts for liquid end gamma/ X 1602 - 1604 TTT0

Pos.	Description
1	Connector kit
5	Discharge valve
6	Diaphragm
8	Suction valve

Liquid end gamma/ X 1602

	TTT0
Liquid end	1051016
Spare parts kit	1001739
Diaphragm	1000246

Liquid end gamma/ X 1604

	TTT0
Liquid end	1051017
Spare parts kit	1035331
Diaphragm	1034612

Liquid end gamma/ X 0708 (1009) - 0220 (0424) TTT0

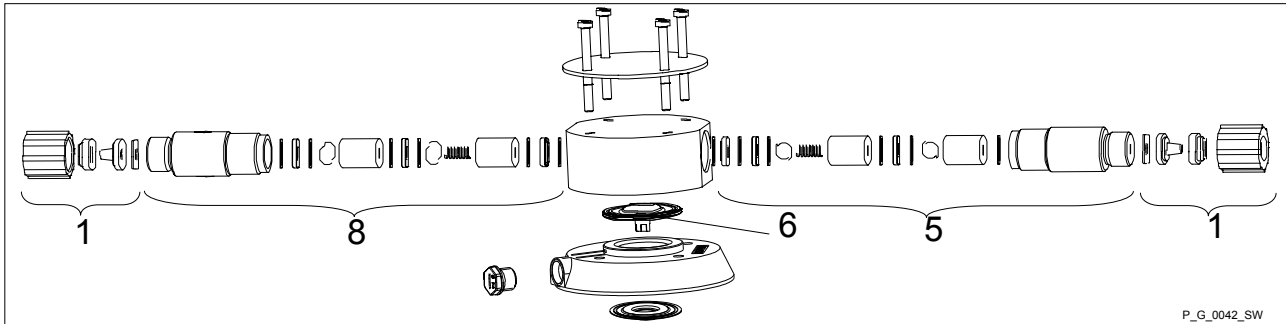

Fig. 52

Tab. 41: Liquid end gamma/ X 0708 (1009) - 0220 (0424) TTT0

Pos.	Description
1	Connector kit
5	Discharge valve
6	Diaphragm
8	Suction valve

Liquid end gamma/ X 0708 (1009)

	TTT0
Liquid end	1051018
Spare parts kit	1001741
Diaphragm	1000248

Liquid end gamma/ X 0414 (0715)

	TTT0
Liquid end	1051019
Spare parts kit	1001742
Diaphragm	1000249

Liquid end gamma/ X 0220 (0424)

	TTT0
Liquid end	1051020
Spare parts kit	1051151
Diaphragm	1045456

Liquid end gamma/ X 0245 TTT0

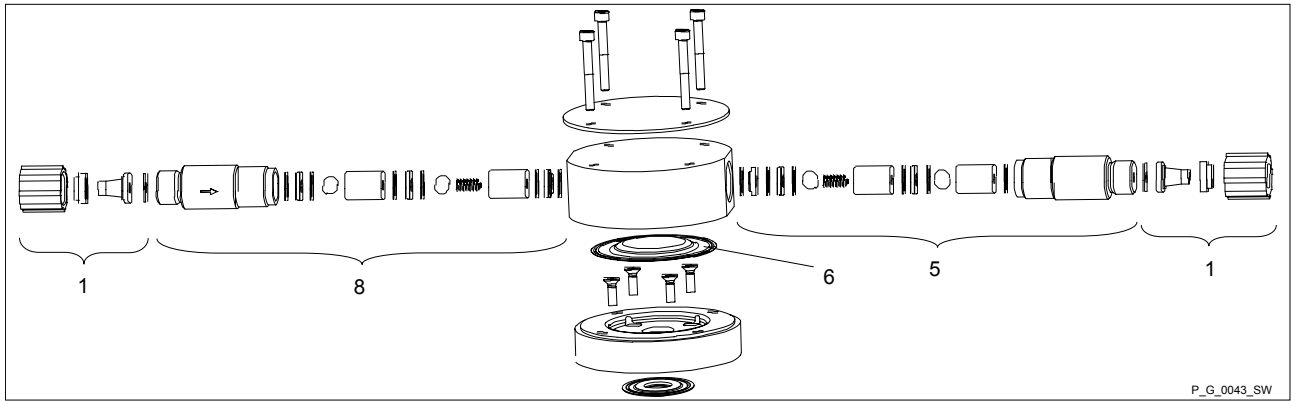

Fig. 53

Tab. 42: Spare parts kit for liquid end gamma/ X 0245 TTT0

Pos.	Description
1	Connector kit
5	Discharge valve
6	Diaphragm
8	Suction valve

Liquid end gamma/ X 0245

	TTT0
Liquid end	1051021
Spare parts kit	1051152
Diaphragm	1045443

Liquid end gamma/ X 1602 - 2504
SST0

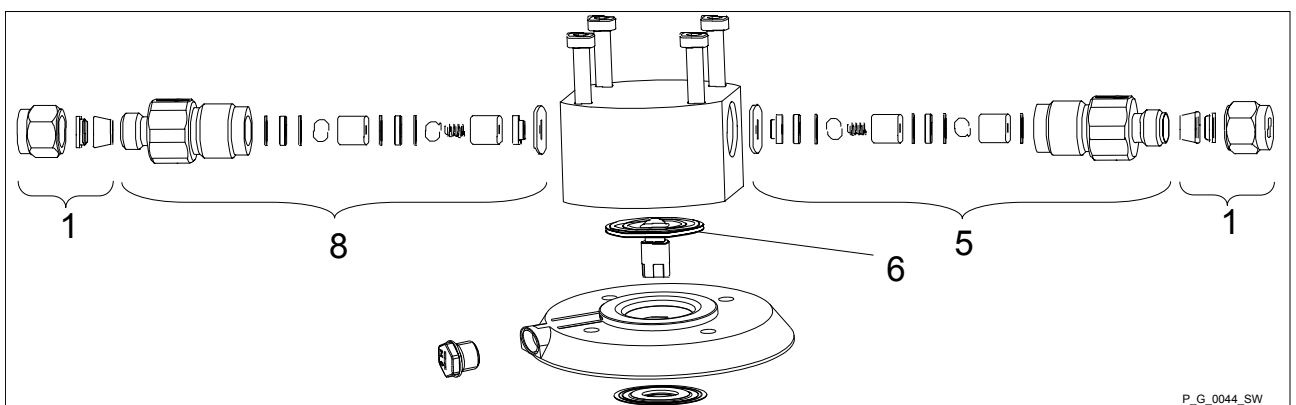

Fig. 54

Tab. 43: Spare parts for liquid end gamma/ X 1602 - 2504 SST0

Pos.	Description
1	Connector kit
5	Discharge valve
6	Diaphragm
8	Suction valve

Liquid end gamma/ X 1602 (2002)

	SST0
Liquid end	1051004
Spare parts kit	1001731
Diaphragm	1000246

Liquid end gamma/ X 1604 (2504)

	SST0
Liquid end	1051005
Spare parts kit	1035331
Diaphragm	1034612

Liquid end gamma/ X 0708 (1009) - 0220 (0424) SST0

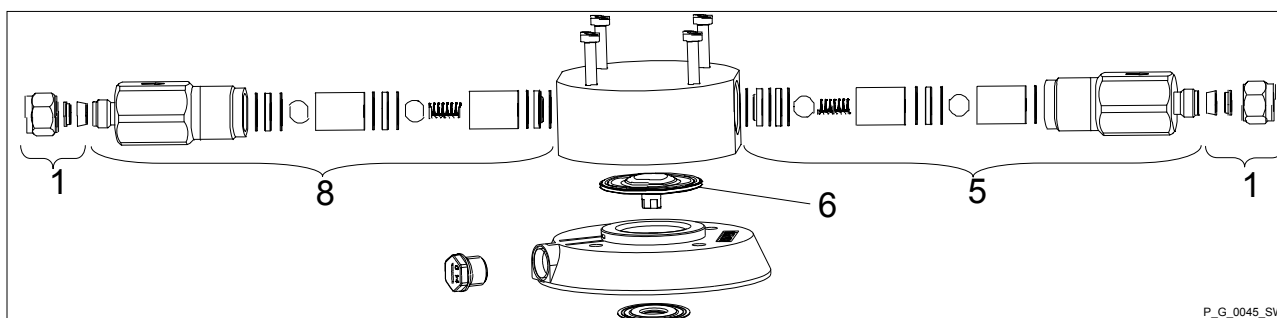

Fig. 55

Tab. 44: Spare parts kit for liquid end gamma/ X 0708 (1009) - 0220 (0424) SST0

Pos.	Description
1	Connector kit
5	Discharge valve
6	Diaphragm
8	Suction valve

Liquid end gamma/ X 0708 (1009)

	SST0
Liquid end	1051006
Spare parts kit	1001733
Diaphragm	1000248

Liquid end gamma/ X 0414 (0715)

	SST0
Liquid end	1051007
Spare parts kit	1001734
Diaphragm	1000249

Liquid end gamma/ X 0220 (0424)

	SST0
Liquid end	1051008
Spare parts kit	1051139
Diaphragm	1045456

Liquid end gamma/ X 0245 SST0

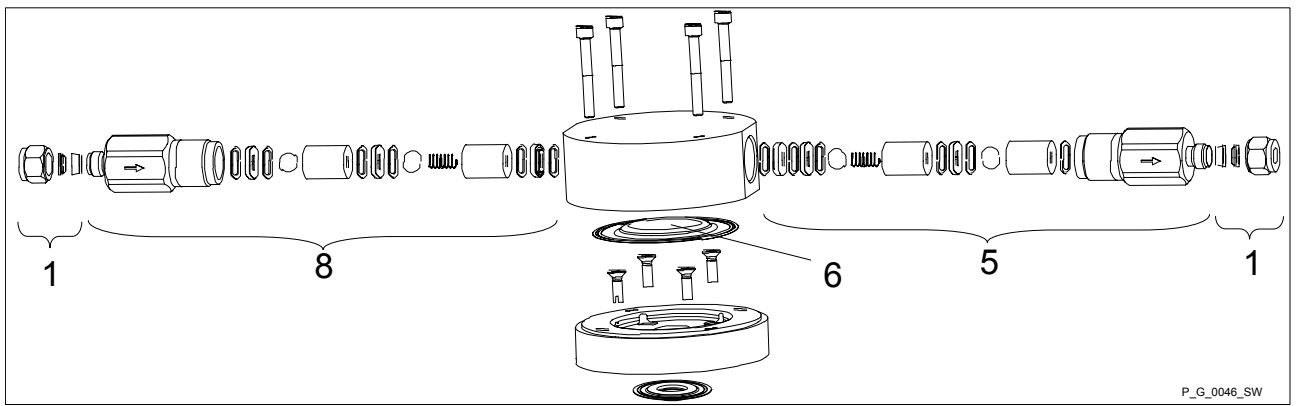

Fig. 56

Tab. 45: Spare parts kit for liquid end gamma/ X 0245 SST0

Pos.	Description
1	Connector kit
5	Discharge valve
6	Diaphragm
8	Suction valve

Liquid end gamma/ X 0245

	SST0
Liquid end	1051009
Spare parts kit	1051140
Diaphragm	1045443

Liquid end gamma/ X 1602 -2504
SER, self-bleeding without bypass,
NPT7

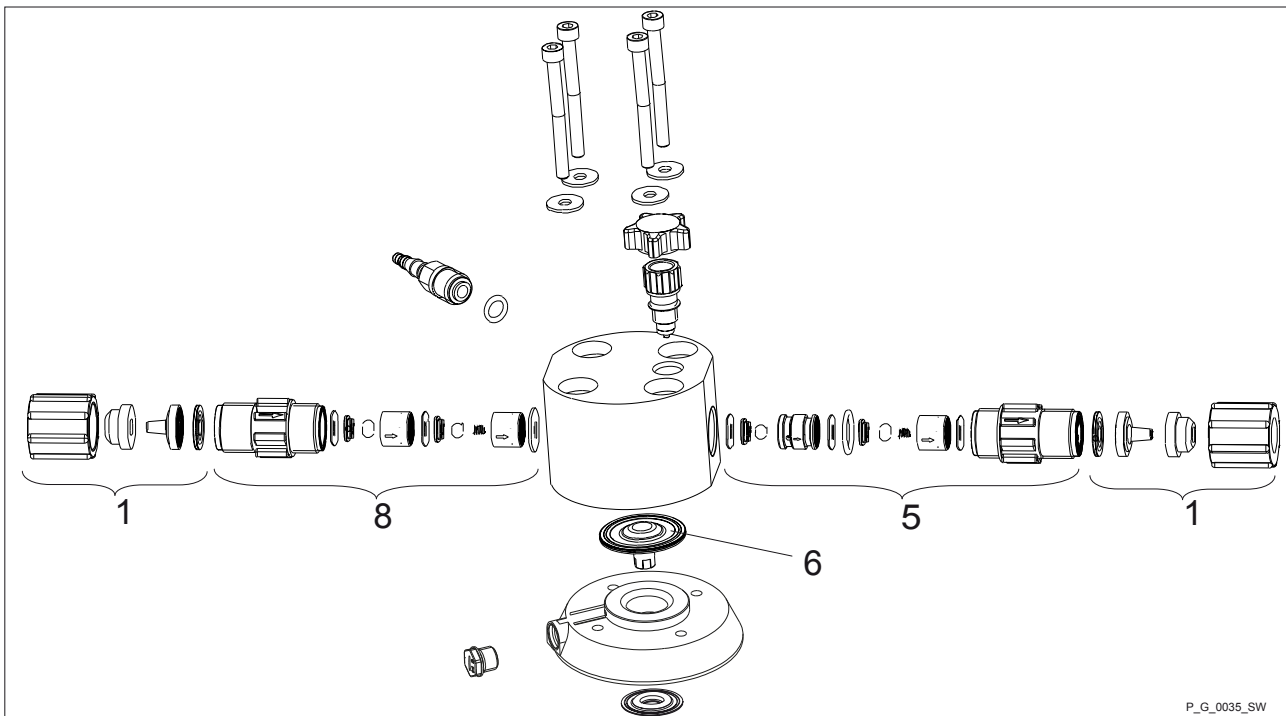

Fig. 57

Tab. 46: Spare parts for liquid end gamma/ X 1602 - 2504 SER, self-bleeding without bypass, NPT7

Pos.	Description
1	Connector kit
5	Discharge valve
6	Diaphragm
8	Suction valve

Liquid end gamma/ X 1602

	NPT7
Liquid end SER, self-bleeding without bypass	1051092
Spare parts kit	1047830
Diaphragm	1000246

Liquid end gamma/ X 1604

	NPT7
Liquid end SER, self-bleeding without bypass	1051093
Spare parts kit	1047858
Diaphragm	1034612

Liquid end gamma/ X 0708 (1009) -
0220 (0424) SER, self-bleeding
without bypass, NPT7

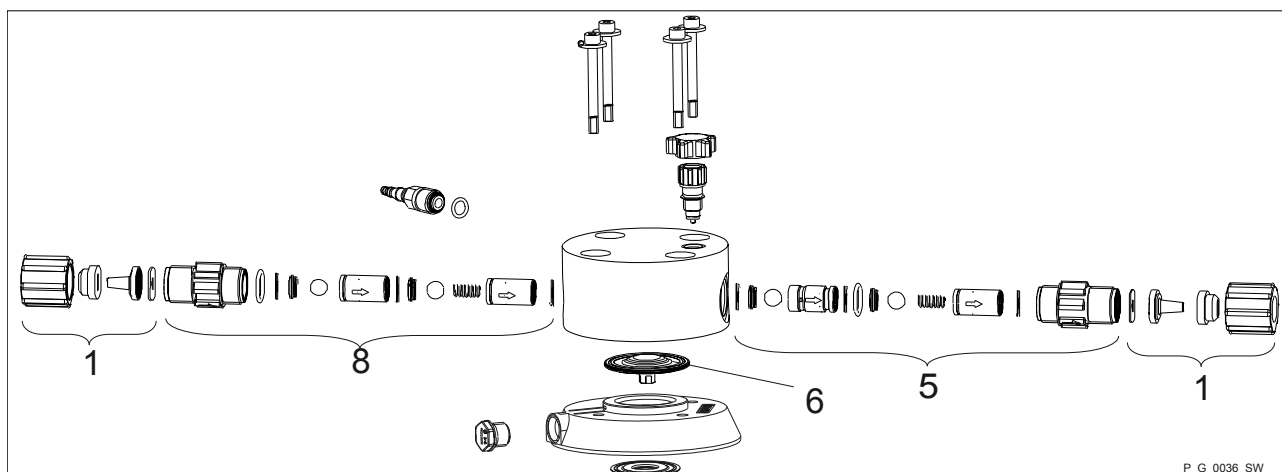

Fig. 58

Tab. 47: Spare parts for liquid end gamma/ X 0708 (1009) - 0220 (0424) SER, self-bleeding without bypass, NPT7

Pos.	Description
1	Connector kit
5	Discharge valve
6	Diaphragm
8	Suction valve

Liquid end gamma/ X 0708 (1009)

	NPT7
Liquid end SER, self-bleeding without bypass	1051094
Spare parts kit	1047832
Diaphragm	1000248

Liquid end gamma/ X 0414 (0715)

	NPT7
Liquid end SER, self-bleeding without bypass	1051095
Spare parts kit	1047833
Diaphragm	1000249

Liquid end gamma/ X 0220 (0424)

	NPT7
Liquid end SER, self-bleeding without bypass	1051098
Spare parts kit	1047837
Diaphragm	1045456

Liquid end gamma/ X 1602 - 1604
SER, self-bleeding without bypass,
PVT7

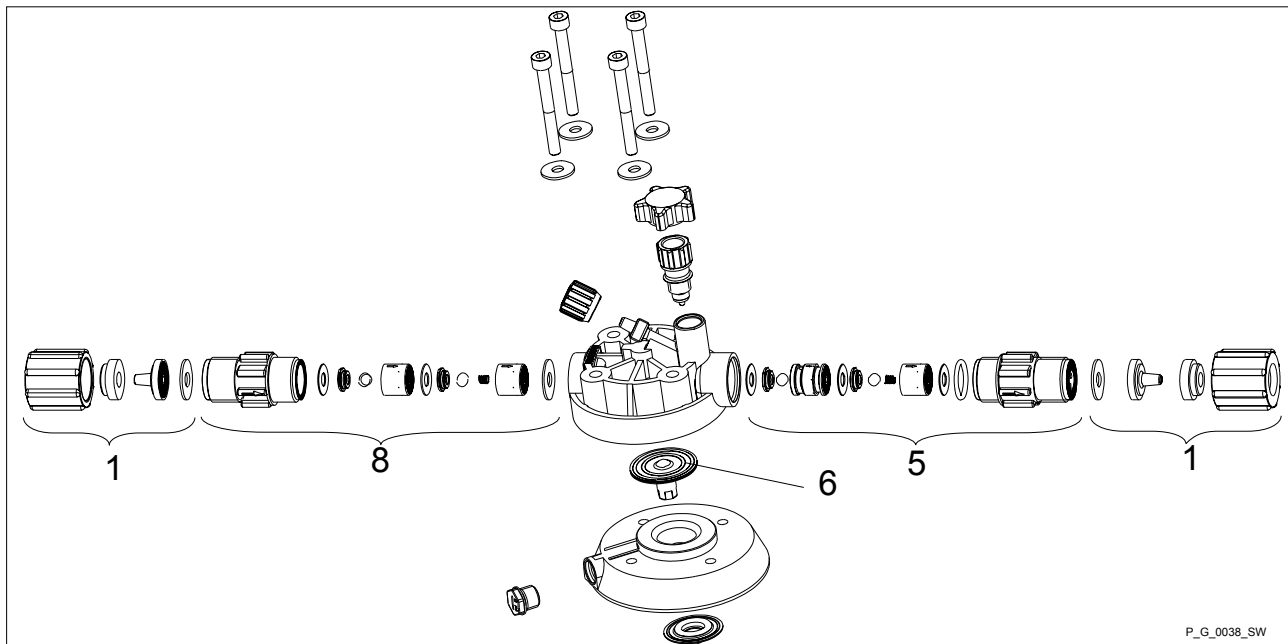

Fig. 59

Tab. 48: Spare parts for liquid end gamma/ X 1602 - 1604 SER, self-bleeding without bypass, PVT7

Pos.	Description
1	Connector kit
5	Discharge valve
6	Diaphragm
8	Suction valve

Liquid end gamma/ X 1602

	PVT7
Liquid end SER, self-bleeding without bypass	1051099
Spare parts kit	1047830
Diaphragm	1000246

Liquid end gamma/ X 1604

	PVT7
Liquid end SER, self-bleeding without bypass,	1051100
Spare parts kit	1047858
Diaphragm	1034612

Liquid end gamma/ X 0708 (1009) -
0220 (0424) SER, self-bleeding
without bypass, PVT7

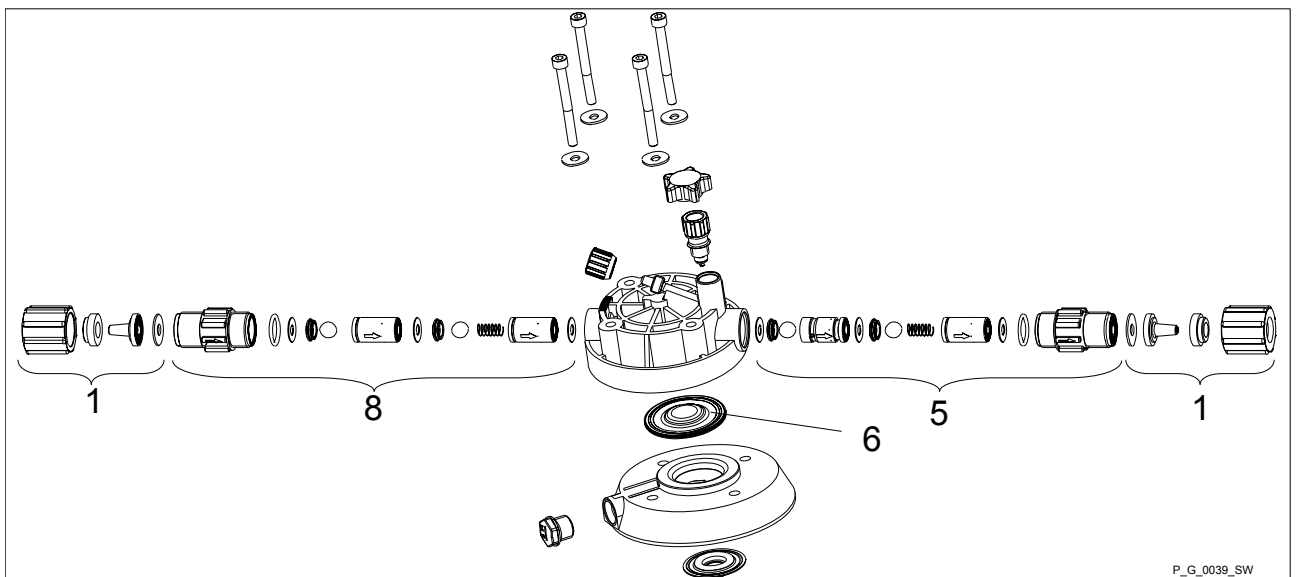

Fig. 60

Tab. 49: Spare parts for liquid end gamma/ X 0708 (1009) - 0220 (0424) SER, self-bleeding without bypass, PVT7

Pos.	Description
1	Connector kit
5	Discharge valve
6	Diaphragm
8	Suction valve

Liquid end gamma/ X 0708 (1009)

	PVT7
Liquid end SER, self-bleeding without bypass	1051101
Spare parts kit	1047832
Diaphragm	1000248

Liquid end gamma/ X 0414 (0715)

	PVT7
Liquid end SER, self-bleeding without bypass	1051103
Spare parts kit	1047833
Diaphragm	1000249

Liquid end gamma/ X 0220 (0424)

	PVT7
Liquid end SER, self-bleeding without bypass	1051104
Spare parts kit	1047837
Diaphragm	1045456

Liquid end gamma/ X 1602 - 1604 PP_9 and NP_9

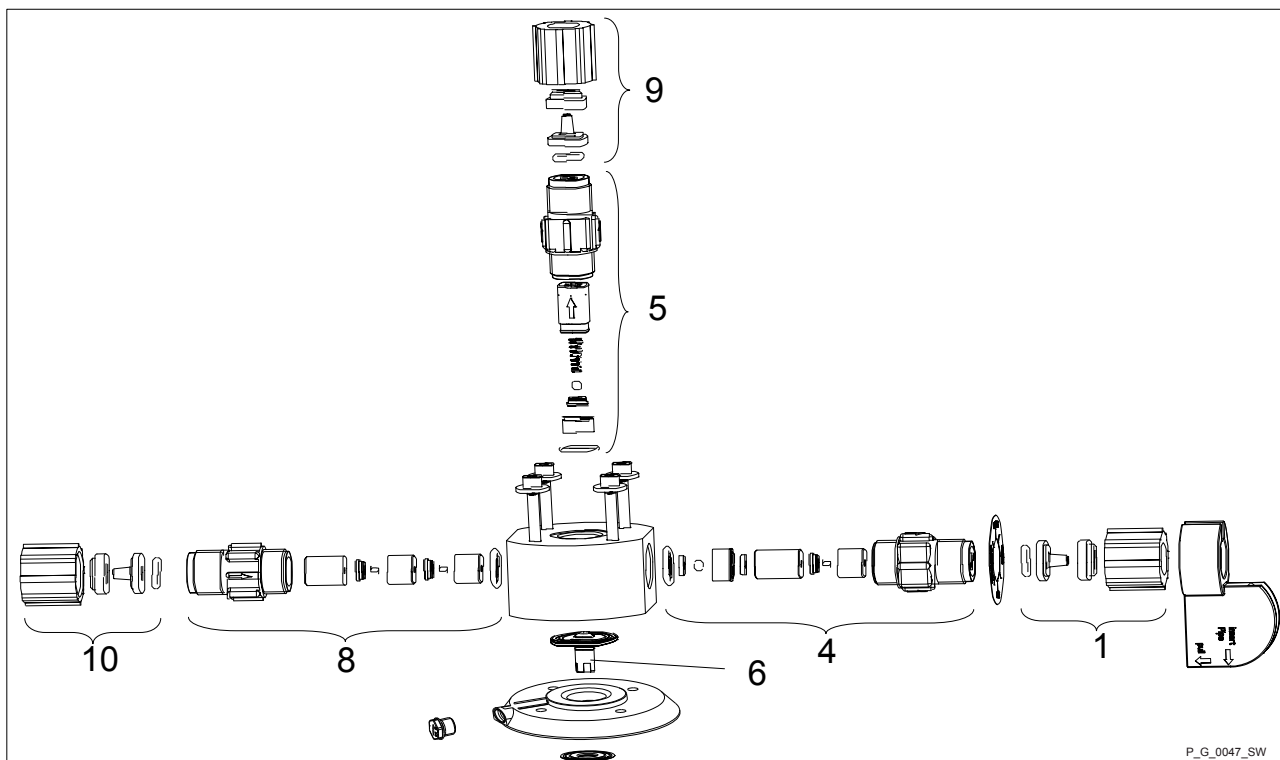

Fig. 61

Pos.	Part
1, 9, 10	Connector kit
4	Bleed valve
5	Discharge valve
6	Diaphragm
8	Suction valve

Tab. 50: Liquid ends

Type	Order No.
PPE_9	-
1602	1050937
1604	1050938
PPB_9	-

Type	Order No.
1602	1050926
1604	1050927

Tab. 51: Liquid ends

Type	Order No.
NPE_9	-
1602	1050977
1604	1050978
NPB_9	-
1602	1050960
1604	1050961

Spare parts kits for type:	Material version	Order No.
1602 with spring	PPE	1001757
1604 with spring	PPE	1035335
1602 with spring	PPB	1001763
1604 with spring	PPB	1035336
1602 with spring	NPE	1001661
1604 with spring	NPE	1035333
1602 with spring	NPB	1001667
1604 with spring	NPB	1035334

Diaphragm for type:	Order No.
1602	1000246
1604	1034612

Liquid end gamma/ X 0708 (1008) -
0220 (0420) PP_9 and NP_9

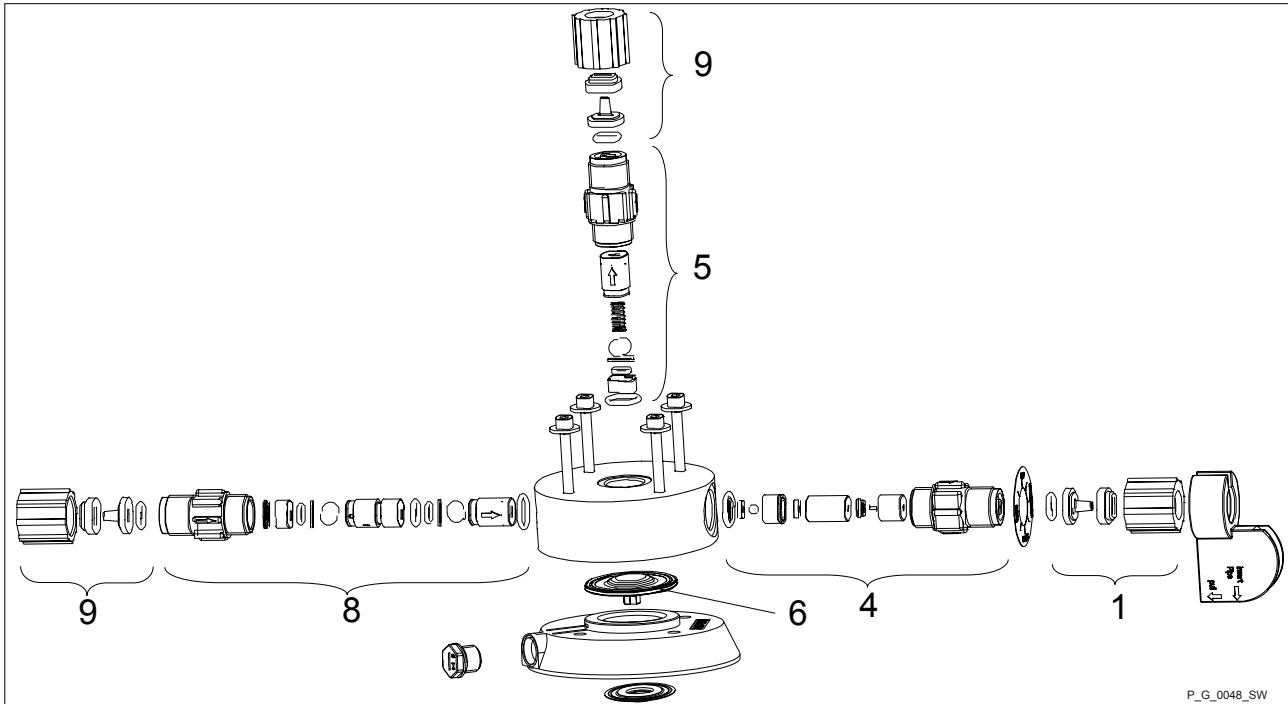

Fig. 62

Pos.	Part
1, 9, 10	Connector kit
4	Bleed valve
5	Discharge valve
6	Diaphragm
8	Suction valve

Tab. 52: Liquid ends

Type	Order No.
PPE9	-
0708 / 1009	1050939
0414 / 0715	1050940
0220 / 0424	1050941
PPB9	-
0708 / 1009	1050928
0414 / 0715	1050929
0220 / 0424	1050930

Tab. 53: Liquid ends

Type	Order No.
NPE9	-
0708 / 1009	1050979
0414 / 0715	1050980
0220 / 0424	1050981
NPB9	-
0708 / 1009	1050962
0414 / 0715	1050963
0220 / 0424	1050964

Spare parts kits for type:	Material version	Order No.
0708 (1008)	PPE	1001759
0413 (0713)	PPE	1001760
0220 (0420)	PPE	1051102
0708 (1008)	PPB	1001765
0413 (0713)	PPB	1001766
0220 (0420)	PPB	1051091
0708 (1008)	NPE	1001663
0413 (0713)	NPE	1001664
0220 (0420)	NPE	1051124
0708 (1008)	NPB	1001669
0413 (0713)	NPB	1001670
0220 (0420)	NPB	1051113

Diaphragm for type:	Order No.
0708	1000248
0413	1000249
0220	1045456

18.2 Ordering information

Retrofit kits

Retrofit kit	Part no.
Fault indicating relay:	1050643
Fault indicating/pacing relay:	1050654
Current output:	1050655
Bleed valve 4-p. 24 V PVF:	1061480
Retrofit kit for bleed valve 3-p. 230 V PVF:	1061481

Further sources of information

Further information on spare parts, accessories and options can be found in:

- the exploded drawings
- the identity code
- in www.prominent.com
- the ProMinent product catalogue

19 Dimensional drawings

i – Compare the dimensions on the dimensional drawing with those of the pump and mounting foot.
 – All dimensions are in mm.

Dimensional drawing of gamma/ X mounting foot

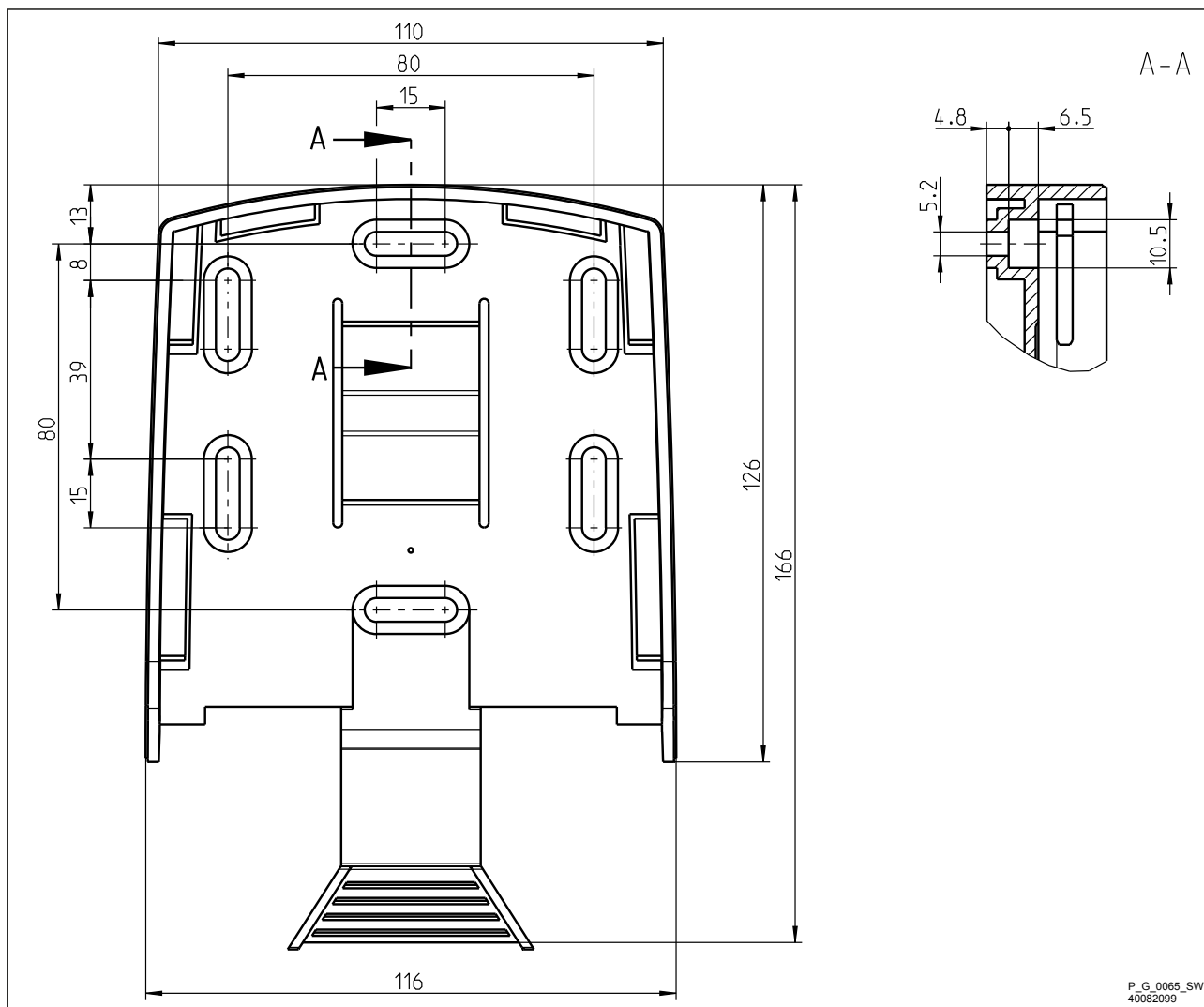
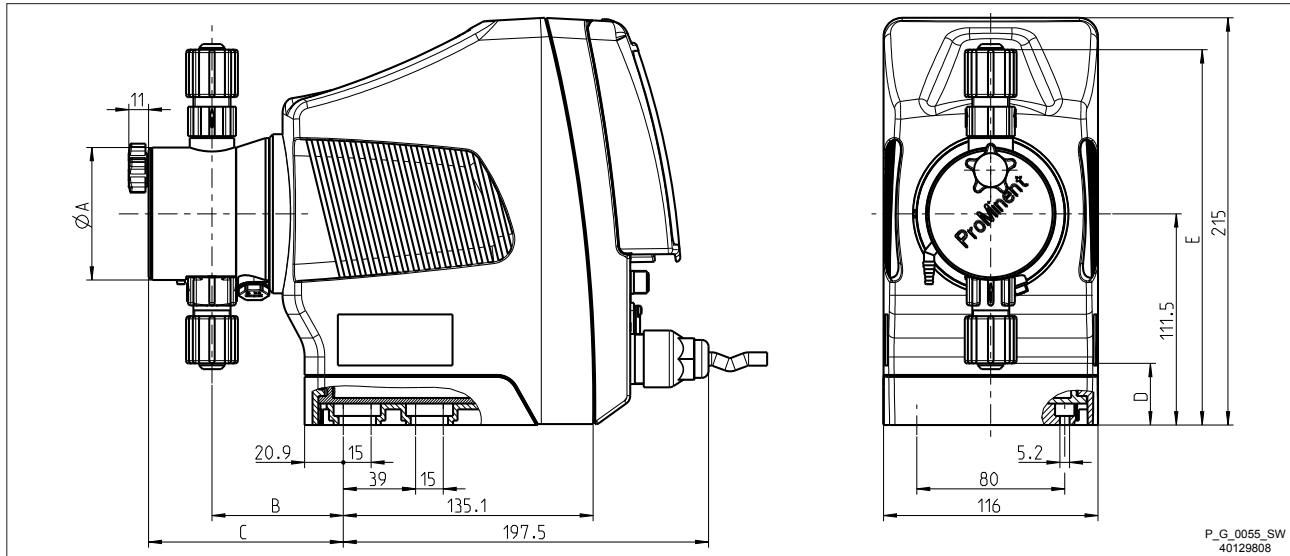

Fig. 63

Dimensional drawing gamma/ X,
material versions PP_2



P_G_0055_SW
40129808

Fig. 64

	gamma/ X M70					gamma/ X M85			
	1602	1604	0708	0414	0220	1009	0715	0424	0245
ØA	70	70	90	90	90	90	90	90	110
B	71	71	74	74	76	74	74	76	76
C (with bleed valve)	106	106	108	107	110	108	107	110	-
C (without bleed valve)	-	-	-	-	-	-	-	-	93
D	32	32	24	24	24	24	24	24	14
E	198	198	202	202	202	202	202	202	209

Dimensional drawing gamma/ X,
material versions NP_2

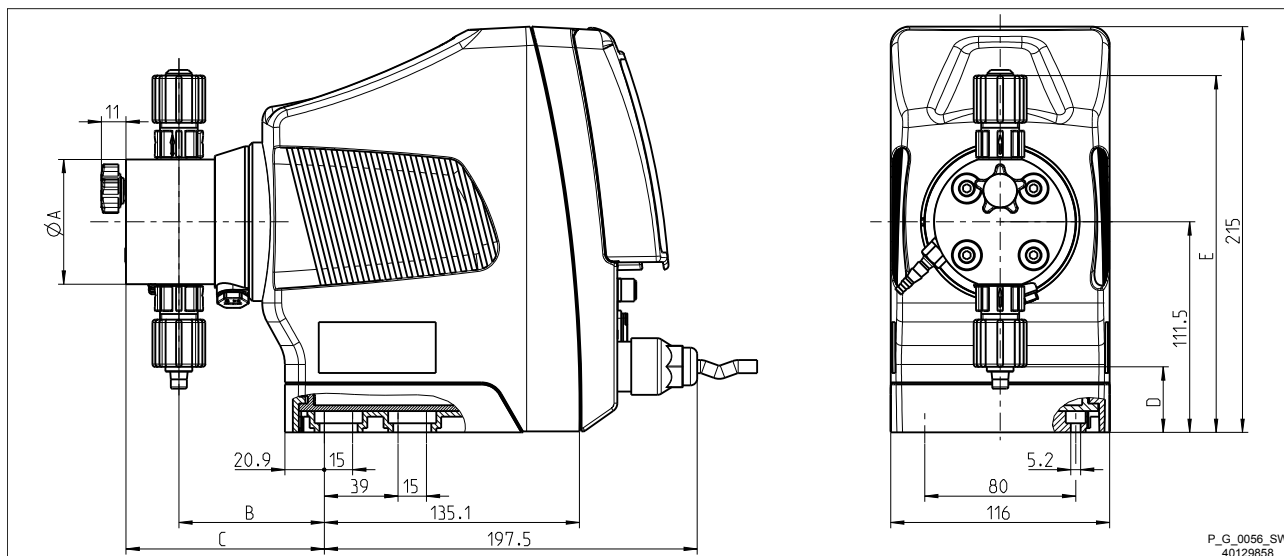

Fig. 65

	gamma/ X M70					gamma/ X M85				
	1602	1604	0708	0414	0220	2504	1009	0715	0424	0245
ØA	70	70	90	90	90	70	90	90	90	110
B	77	77	74	76	76	77	74	76	76	76
C (with bleed valve)	105	105	102	104	104	105	102	104	104	105
C (without bleed valve)	92	92	91	91	91	92	91	91	91	91
D	33	33	23	23	23	33	23	23	23	14
E	191	191	200	200	200	191	200	200	200	210

Dimensional drawing gamma/ X,
material version PVT2

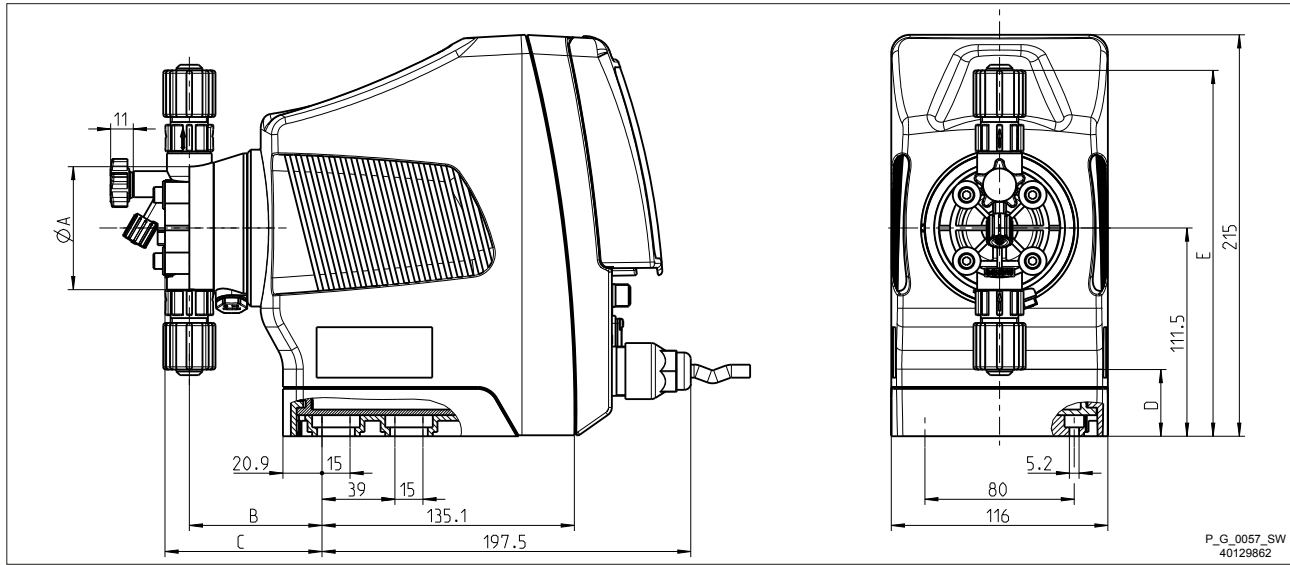

Fig. 66

	gamma/ X M70					gamma/ X M85			
	1602	1604	0708	0414	0220	1009	0715	0424	0245
ØA	70	70	90	90	90	90	90	90	110
B	71	71	75	73	79	75	73	79	76
C (with bleed valve)	84	84	92	90	90	92	90	90	-
C (without bleed valve)	-	-	-	-	-	-	-	-	93
D	36	36	25	25	25	25	25	25	14
E	196	196	203	203	203	203	203	203	209

Dimensional drawing gamma/ X,
material version PVT4

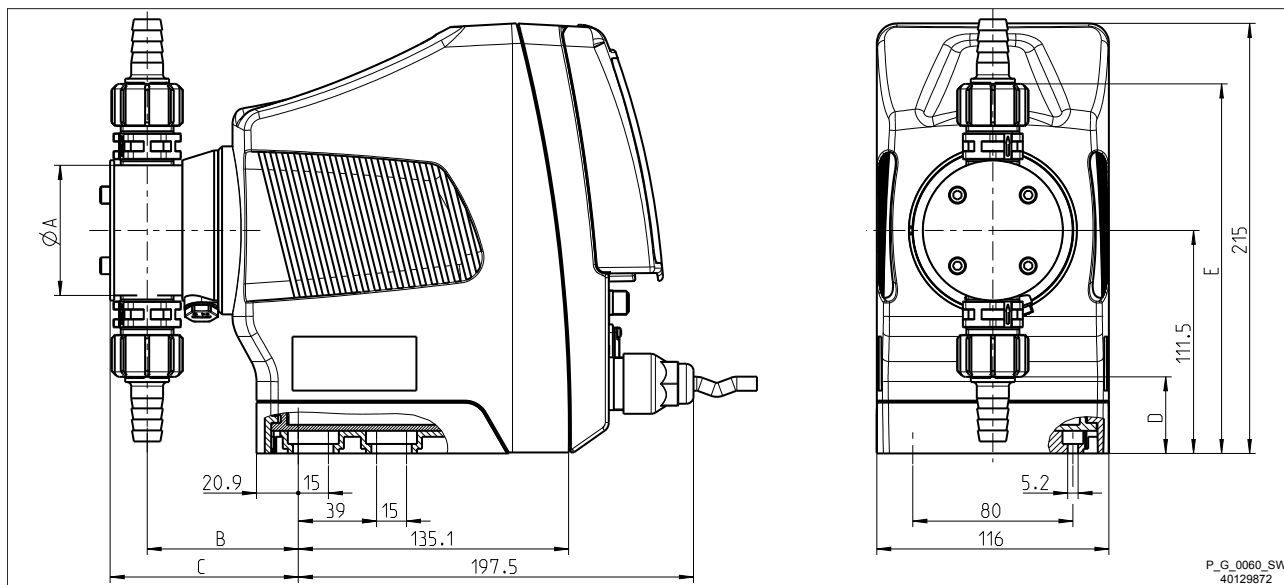

Fig. 67

	gamma/ X M70				gamma/ X M85		
	1604	0708	0414	0220	1009	0715	0424
ØA	70	80	80	85	80	80	85
B	76	78	78	79	78	78	79
C	94	96	96	97	96	96	97
D	38	33	33	30	33	33	30
E	185	190	190	193	190	190	193

Dimensional drawing gamma/ X,
material version TTT0

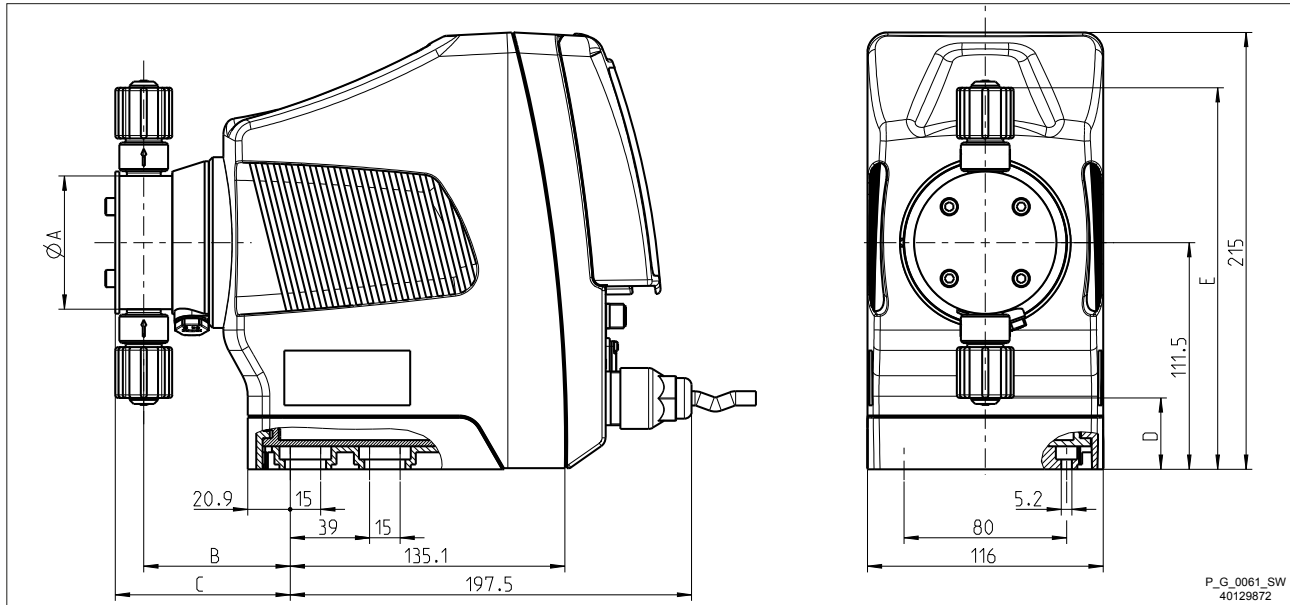

Fig. 68

	gamma/ X M70					gamma/ X M85			
	1602	1604	0708	0414	0220	1009	0715	0424	0245
ØA	70	70	85	85	85	85	85	85	100
B	72	72	79	77	77	79	77	77	78
C	86	86	96	96	96	96	96	96	97
D	35	35	3	3	3	3	3	3	-5
E	188	188	220	220	202	220	220	202	227

Dimensional drawing gamma/ X,
material version SST0

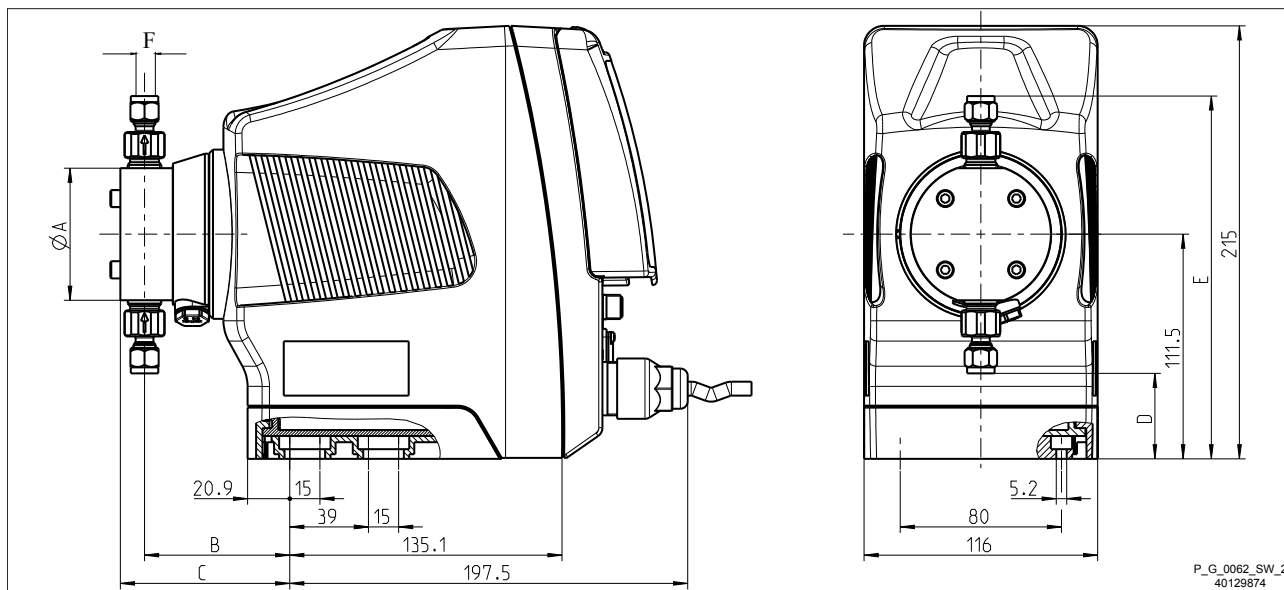

Fig. 69

	gamma/ X M70					gamma/ X M85				
	1602 2002	1604	0708	0414	0220	2504	1009	0715	0424	0245
ØA	70	70	85	85	85	70	85	85	85	100
B	72	72	79	77	77	72	79	77	77	79
C	84	84	94	94	94	84	94	94	94	95
D	42	42	11	11	11	42	11	11	11	15.8
E	180	180	211	211	211	180	211	211	211	207.3
F	6	6	8	12	12	6	8	12	12	ISO - Rp 3/8

Dimensional drawing gamma/ X,
material version PPB9

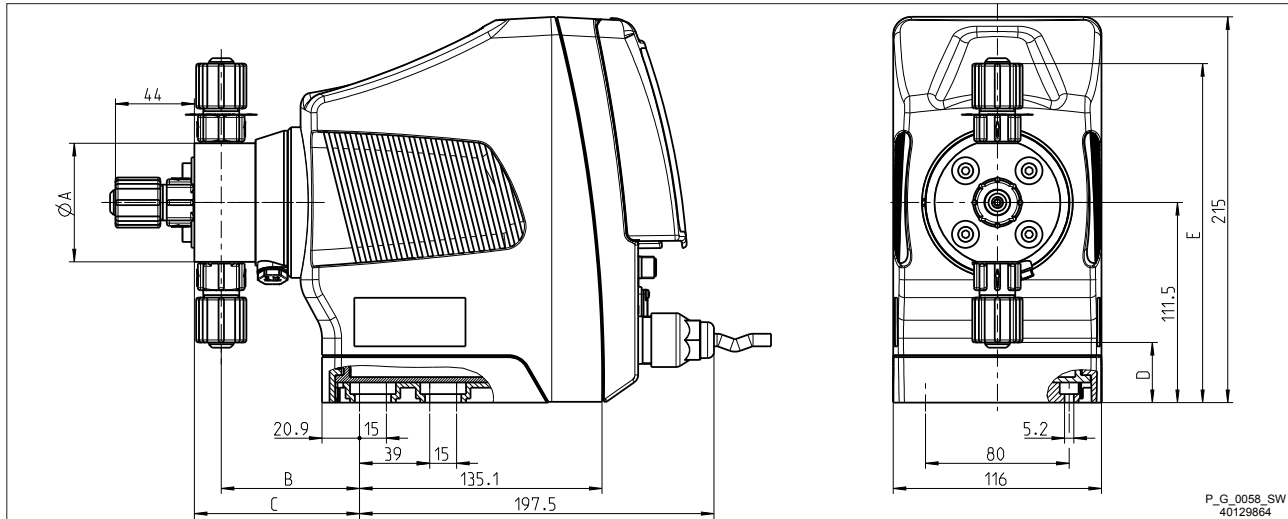

Fig. 70

	gamma/ X M70					gamma/ X M85		
	1602	1604	0708	0414	0220	1009	0715	0424
ØA	70	70	90	90	90	90	90	90
B	77	77	74	76	76	74	76	76
C	92	92	89	91	91	89	91	91
D	33	33	24	24	24	24	24	24
E	189	189	199	199	199	199	199	199

Dimensional drawing gamma/ X,
material version NPB9

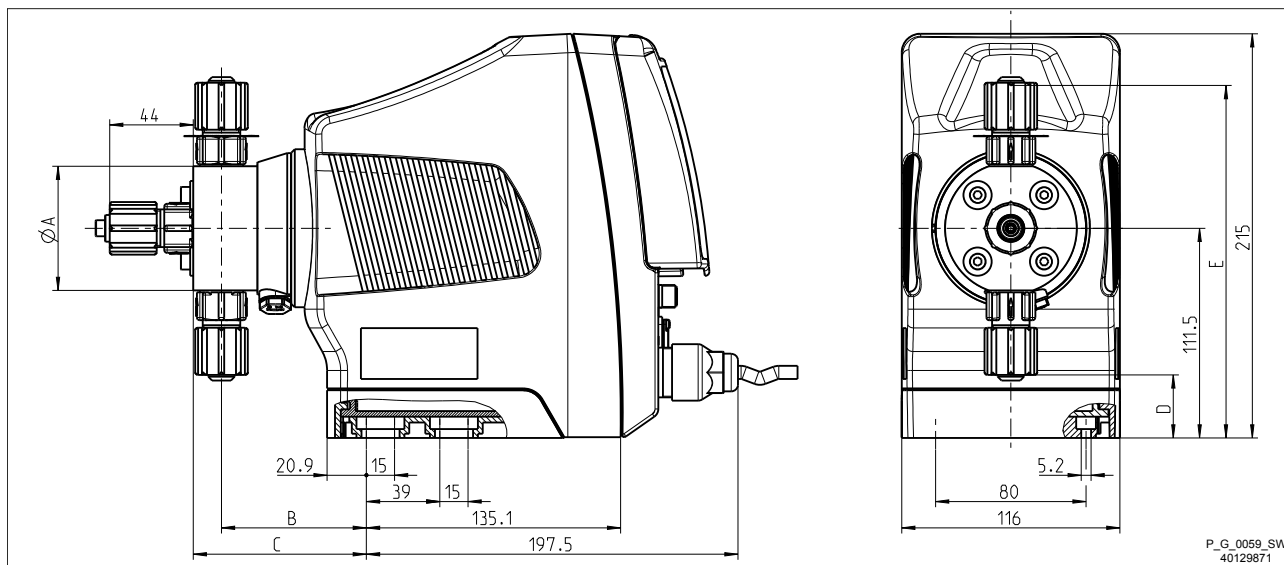

Fig. 71

	gamma/ X M70					gamma/ X M85		
	1602	1604	0708	0414	0220	1009	0715	0424
ØA	70	70	90	90	90	90	90	90
B	77	77	76	76	76	76	76	76
C	92	92	91	91	91	91	91	91
D	33	33	24	24	24	24	24	24
E	189	189	199	199	199	199	199	199

20 Diagrams for Setting the Capacity

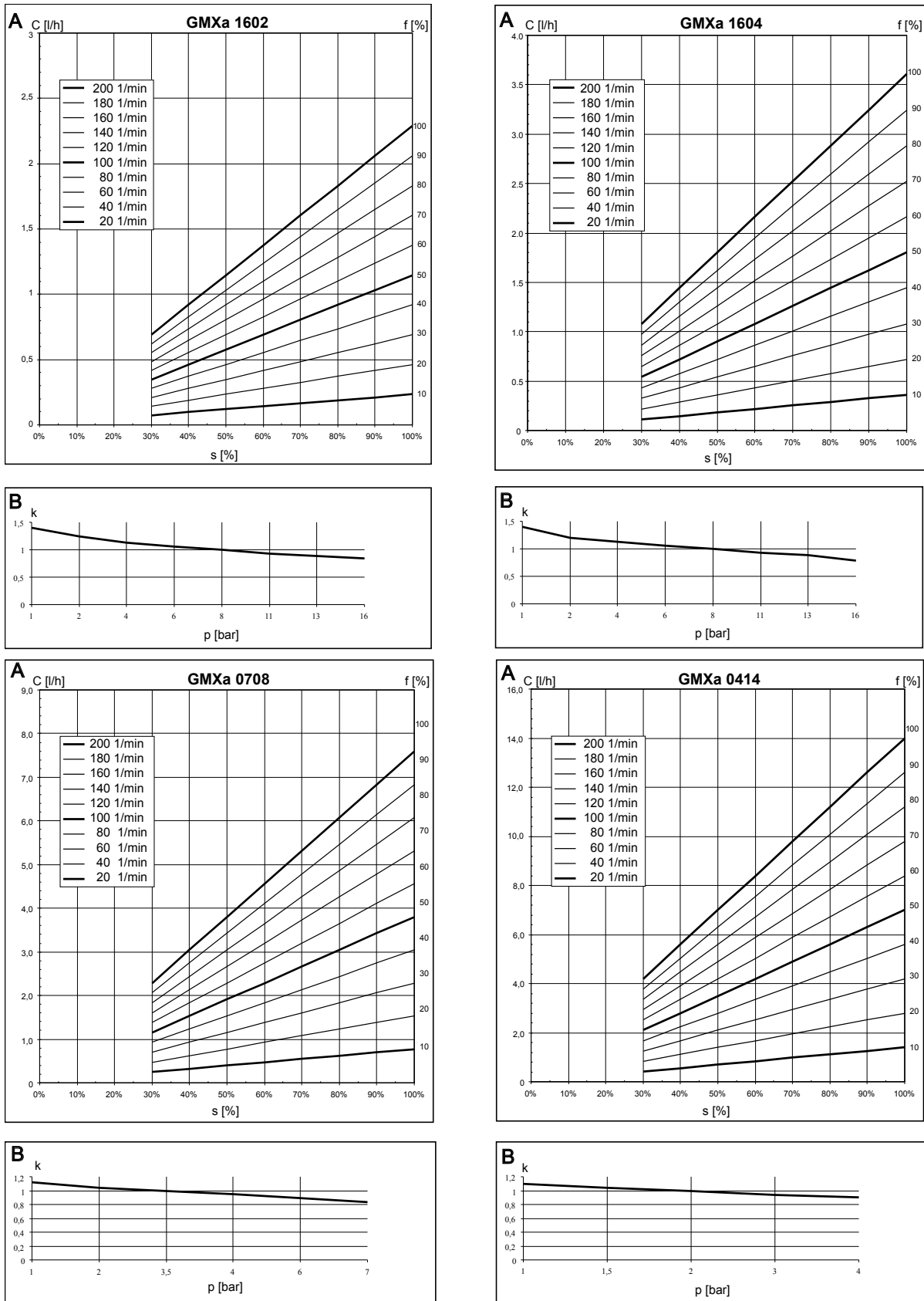

Fig. 72: A) Capacity C at maximum back pressure depending on the stroke length s for different stroke rates f . - B) Corresponding correction factors k dependent on back pressure p - at 70 % stroke length, "Automatic"- "Off" and "Compensation"- "Off".

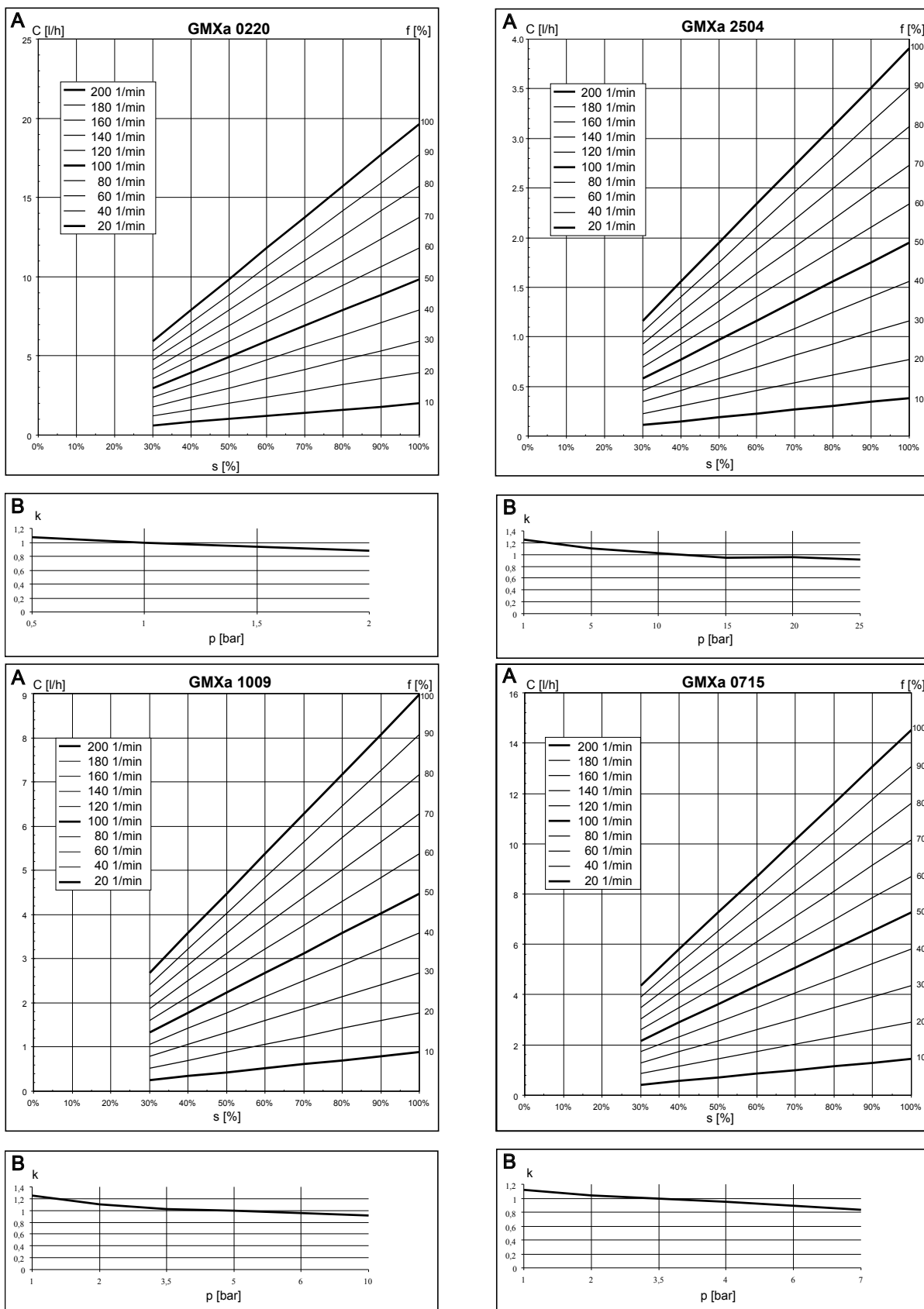

Fig. 73: A) Capacity C at maximum back pressure depending on the stroke length s for different stroke rates f. - B) Corresponding correction factors k dependent on back pressure p - at 70 % stroke length, "Automatic"- "Off" and "Compensation"- "Off".

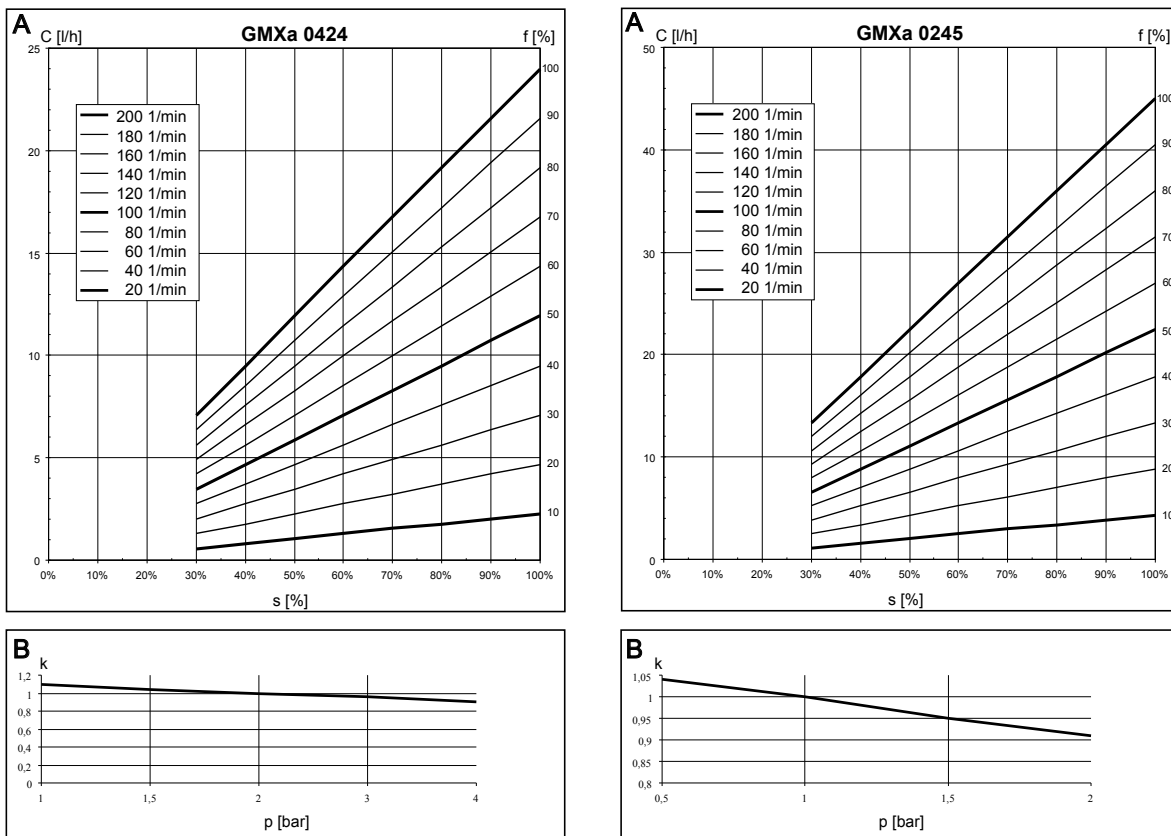

Fig. 74: A) Capacity C at maximum back pressure depending on the stroke length s for different stroke rates f . - B) Corresponding correction factors k dependent on back pressure p - at 70 % stroke length, "Automatic"- "Off" and "Compensation"- "Off".

21 Declaration of Conformity for Machinery

For mains voltage pumps:

In accordance with DIRECTIVE 2006/42/EC OF THE EUROPEAN PARLIAMENT AND OF THE COUNCIL, Appendix I, BASIC HEALTH AND SAFETY REQUIREMENTS, section 1.7.4.2. C.

We,

- ProMinent GmbH
- Im Schuhmachergewann 5 - 11
- D - 69123 Heidelberg, Germany,

hereby declare that the product specified in the following, complies with the relevant basic health and safety requirements of the EC Directive, on the basis of its functional concept and design and in the version distributed by us.

Any modification to the product not approved by us will invalidate this declaration.

Tab. 54: Extract from the Declaration of Conformity

Designation of the product:	Metering pump, gamma/ X product range
Product type:	GMXa _____ U ___ Y _ 0 Y = 0, 3, 4, 5
Serial number:	see nameplate on the device
Relevant EC directives:	Machinery Directive (2006/42/EC) Compliance with the protection targets of the Low Voltage Directive according to Appendix I, No. 1.5.1 of the Machinery Directive RoHS Directive (2011/65/EU) EMC Directive (2014/30/EU)
Harmonised standards applied, in particular:	EN ISO 12100: 2010 EN 809:1998 + A1:2009 + AC:2010 EN 61010-1:2010 EN 50581:2012 EN 61000-6-2:2005 + AC:2005 EN 61000-6-3:2007 + A1:2011 +AC:2012
Date:	20/04/2016

You will find the EC Declaration of Conformity to download on our homepage.

22 UK Declaration of Conformity

We,

- ProMinent GmbH
- Im Schuhmachergewann 5 - 11
- D - 69123 Heidelberg
- Germany

herby declare that the product identified below conforms to the basic health and safety requirements of the Regulations, by virtue of its design and construction, and in the configuration placed on the market by us.

This declaration is no longer applicable if changes are made to the product without our authorisation.

Tab. 55: Extract from the Declaration of Conformity

Product description:	Dosing pump, gamma/ X series
Product type:	GMXa _____ U ___ Y _ 0 __ Y = 0, 3, 4, 5, C, D, E, N, R
Serial no.:	see type plate on the unit
Applicable Regulations:	Supply of Machinery (Safety) Regulations 2008 The safety objectives of the Electrical Equipment (Safety) Regulations 2016 were complied with in accordance with Appendix 1, No. 1.5.1 of the Supply of Machinery (Safety) Regulations 2008 Restriction of the Use of Certain Hazardous Substances in Electrical and Electronic Equipment Regulations 2012
Applied standards, especially:	BS EN ISO 12100: 2010 BS EN 809:1998 + A1:2009 BS EN 61010-1:2010 + A1:2019 BS EN 61000-6-2:2005 BS EN 61000-6-3:2007 + A1:2011 BS EN 61000-6-4:2007 / A1:2011 for Y = E BS EN IEC 63000:2018
Date:	01.12.2020

You will find the UK Declaration of Conformity to download on our homepage.

23 Approvals

Other certifications

The pump has CE approval and the following certifications:

Certification	Certificate no.
EAC	TC N RU D-DE.IA58.B.03108
c MET _{US}	-
NSF61	-

24 Operating/Set-up overview of the gamma/ X

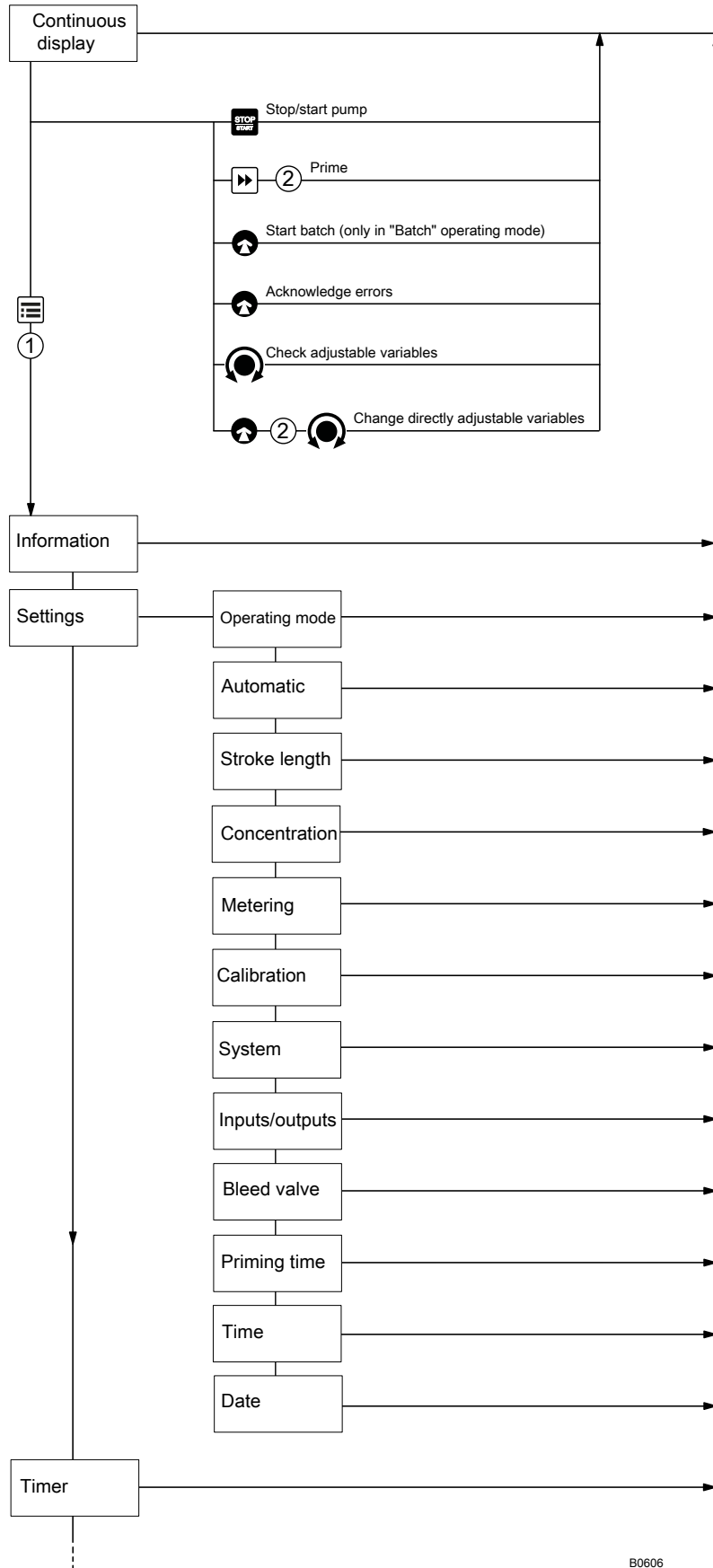

B0606

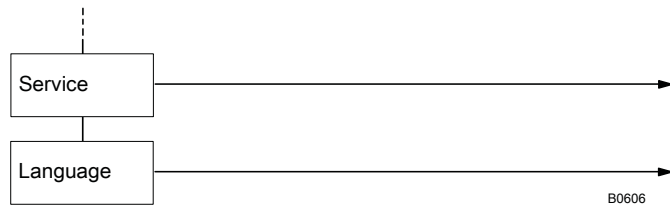

25 gamma/ X operating menu, overall

1st level	2nd	3rd	4th	5th	xth	
Information	Versions	Hardware				
		Software				
		HMI version				
		Time				
		Date				
		Max. capacity *1				
		Max. capacity *2				
		Serial number				
		Identity code				
		Switch-on counter				
		Total operating time				
		Total metering volume				
		Total number of strokes				
		Total metering volume				
		Current stroke volume				
		Part name				
		Part device address				
	Settings	Operating mode	Manual			
			Contact	<i>Adaptive</i> On Off	<i>Memory</i> On Off	Metering volume *1 Factor *2
		Batch	<i>Memory</i> On Off	Metering volume *1		
				Factor *2	...	
		Analogue		0...20 mA		
				4...20 mA		
			Linear curve Lower side band Upper side band	Curve point 1 (I1,F1)	...	

1st level	2nd	3rd	4th	5th	xth
	Automatic	On Off			
	Stroke length *2	1 ... 100%			
	Dosing	Discharge stroke	optimum fast sine mode continuous DFMa		
		Suction stroke	normal HV1 HV2 HV3		
		Pressure stage	x bar		
		Monitoring	Air lock	Inactive Warning Fault	
			Air sensitivity	normal average weak	
			Message with overpressure	Inactive Error+warning Warning Fault	
			Message when no pressure	Inactive Warning Fault Error+warning	
			Cavitation	Inactive Warning	
		Compensation	Inactive Active		
		Adaptive control	Inactive Adaptive Save param. Restore old values		
	Concentration	Concentration control active inactive	Flow of main medium (for Manual)	Concentration of feed chemical	...

1st level	2nd	3rd	4th	5th	xth
			Contact gap (for Contact)	Concentration of feed chemical	...
			Volume of main medium (for Batch)	Concentration of feed chemical	...
			Max. flow of main medium (for Analogue)	Concentration of feed chemical	...
	Calibrate	Calibration factor	Calibration factor		
		Calibrate	Start calibration	Calibration ended	Calibration result
	System	Bluetooth	active inactive		
		Dosing head	No dosing head ... 0245		
		Volume unit	Litres Gallons		
		Pressure unit	bar psi		
		Pressure adjustment	... bar		
		Start behaviour	always STOP always on last status		
	Inputs/outputs	Auxiliary capacity *1 Auxiliary frequency *2 Auxiliary stroke length *2	...		
		Relay 1	Relay1 type	Timer Fault Warning Warning + error Warning, error + manual stop Pump active Cycle quantity Stroke rate Metering / Batch Bleeding	

1st level	2nd	3rd	4th	5th	xth
			Relay 1 polarity	energizing (N/O) releasing (N/C)	
			Relay cycle quantity	01.000 l	
		Relay 2	Relay type	Inactive Fault Warning Warning + error Warning, error + manual stop Pump active Metering volume Stroke rate Metering / Batch Bleeding External	
			Polarity	energizing (N/O) releasing (N/C)	
		mA output	0...20 mA 4...20 mA	Strokes / hour Litre / hour at 20 mA	...
		Flow control	Flow Control	Tolerance / strokes	...
				Activation	...
				if auxiliary	...
		diaphragm rupture	Inactive Warning Fault		
		Pause input	N/C N/O		
		Level warning	N/C N/O		
		Level error	N/C N/O		
	Bleeding	Off			
		Periodic	Bleed cycle	Bleed metering time	...
		Air lock	Bleed metering time		
		both	Bleed cycle	Bleed metering time	...
	Priming time	0 ... 60 s			

1st level	2nd	3rd	4th	5th	xth
	Set time	Time	Setting	hh.mm.ss	
		Auto. summer time	Yes No		
		Summer time begins in	February March April		
		Sunday the	1st, 2nd, 3rd, 4th, 5th		
		Summer time ends in	August September October November		
		Sunday the	1st, 2nd, 3rd, 4th, 5th		
		Location	Northern Hemisphere Southern Hemisphere		
	Date	dd.mm.yyyy			
Timer	Timer status				
	Activation	Active Inactive			
	Setting the timer	New Displays Change Clear	Command 01 Anweisung2 ...	Init Hourly Daily (Mon-Sun) Weekdays1 (Mo-Fr) Weekdays2 (Mo-Sa) Weekend (Sa+Su) Weekly Monthly	...
	Clear all	No Yes			
Service	Access protection	<i>Password?</i>	None Lock menu Lock all		
	Password	<i>Password?</i>	0000		
	Clear counter	Stroke counter Quantity counter All			

1st level	2nd	3rd	4th	5th	xth
	Error log book	Error log book	...		
		Filter	None Warn.+error only Error only Warnings only Events only		
	Diaphragm replacement	Back To change position			
	Display	Brightness			
		Contrast			
	Factory setting	<i>Password?</i>	Yes No		
	Diaphragm part number: XXXXXXX				
	Spare parts kit part number: XXXXXXX				
Language	English German Frenchç Spanishñ ...				

*1 with 'Automatic' - 'on' - see Chap. 'Set Up' - 'Settings' - 'Automatic'

*2 with 'Automatic' - 'off' / with conventional operating mode

Menus may be missing or added depending on the design and equipment on the pump.

26 Continuous Displays and Secondary Displays

Continuous displays

Continuous display	"Manual" operating mode	"Contact" operating mode with transfer factor 5	"Batch" operating mode with transfer factor 5	"Analogue" operating mode
Capacity	12.00 _h **	12000 _h *	12,000 _h *	12.00 _h **
Stroke rate (h)	12,000 _h *	12000 _h *	12,000 _h *	12,000 _h *
Stroke rate (min)	200 _{h/min} *	200 _{h/min} *	200 _{h/min} *	200 _{h/min} *
Stroke length	50.0 _% *	50.0 _% *	50.0 _% *	50.0 _% *
Factor		5 _{h/∧} *	5 _{h/∧} *	
Contact volume		1,250 _{∧/∧} **	1,250 _{∧/∧} **	
Batch dosing time			90 _s **	
Concentration	03.5 _% **	03.5 _% **	03.5 _% **	03.5 _% **
Trigger batch			 PUSH	
Time	16:12:21	16:12:21	16:12:21	16:12:21

* only with "Automatic" off

* only with "Automatic" on

Auxiliary displays in the continuous display

Auxiliary display	Mode "Manual"	Mode "Batch" with transfer factor 5	Mode "Contact" with transfer factor 5	Mode "Analogue"
Capacity	12.00 L/h			12.00 L/h
Stroke rate	12000 Cp/h	12000 Cp/h	12000 Cp/h	12000 Cp/h
Factor		5 Cp/...	5 Cp/...	
Remaining strokes			25,00 ↓ Cp ¹	
Remaining litres			000,833 ↓ L ¹	
Total number of strokes	86500 Cp	86500 Cp	86500 Cp	86500 Cp
Stroke length	50 %	50 %	50 %	50 %
Signal current (at the input)				12,7 mA ²
Dosing mode	slow HV1	slow HV1	slow HV1	slow HV1
Pressure display	12.5 bar	12.5 bar	12.5 bar	12.5 bar
Time	16:12:21	16:12:21	16:12:21	16:12:21
Date	2015 - 03 - 27	2015 - 03 - 27	2015 - 03 - 27	2015 - 03 - 27

1 = only with "Storage tank" function extension

2 = only with current output

27 Installation instructions: Retrofitting Relays

These installation instructions apply to:

	Order No.
Fault indicating relay GMXa	1050643
Fault indicating and pacing relay GMXa	1050654



WARNING!

Danger of electrocution.

Live parts can be accessed if the slot for the relay has been opened.

- Disconnect the pump from the mains/power supply prior to commencing work.
- Only operate the pump with a liquid-tight screwed slot for the relay and connector for the relay cable.

Scope of delivery

- 1 - Relay board, fully ass.
- 1 - Relay cable, fully assembled, with connector
- 1 - Seal

Materials

Torx spanner T 25



A small bright pocket torch can help to find the 4x2 contact in the slot for the relays more easily.

Personnel: ■ Electrician

Prerequisite:

The pump is electrically disconnected.

1. ➤ Remove the cover of the slot.
2. ➤ Hold the relay board by the edge of the relay cover.
3. ➤ Carefully insert the relay board into the slot for the relay - the opening in the board in the slot will help with this (A); at the same time make sure that the 3x2 pins on the relay board are sitting correctly and on the left contacts of the 4x2 contact in the slot (B) - see Figure
4. ➤ Push the relay board with gentle pressure into the slot.
5. ➤ Use the screws to screw the relay cover until liquid-tight with the housing.
6. ➤ Insert the seal of the connector of the relay cable into the relay cover.
7. ➤ Push the connector onto the pins of the relay cover and then tighten the screw into the connector until liquid-tight.

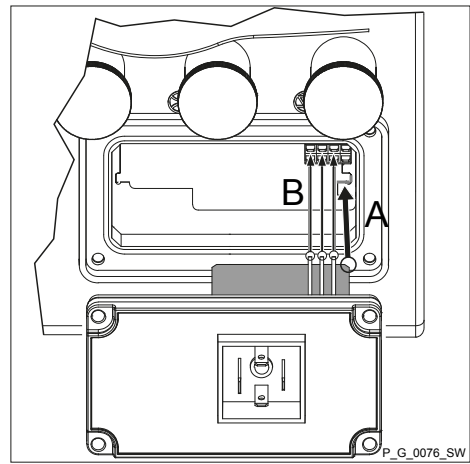

28 Index

1, 2, 3 ...

.....	87
"External control" terminal	41
0...20 mA	76
2-stage	77
4 - 20 mA	56
4...20 mA	76

A

Access code	93
Access protection	51, 92
Accuracy	117
Acknowledgement	96
Adaptive	53
Adjustment	72
Air humidity	120
Air lock	62
Altitude of site	120
Analogue	27, 43
Analogue input	42, 56
Anti-kink device	37
Applicable Regulations	160
Applied harmonised standards	159
Applied standards	160
Approvals	161
Assembly	30
Automatic	58
Automatic degassing	28
AUX	74
Auxiliary capacity	27, 29, 42, 43, 74
Auxiliary frequency	27, 28, 29, 42, 43, 74

B

Back pressure fluctuations	63
Basic principles for setting up the control	49
batch	74
Batch	27, 45, 55, 65, 67, 68
Behaviour, mA output	76
Bleeding	45, 79
Bluetooth Name	52
Brightness	94
BT device address	52

C

Calibrate	27, 70
-----------------	--------

Calibrate, level measurement	78
CAN bus	41
Capacity	156
Capacity at 20 mA	76
Cavitation	60
Check adjustable variables	96
Checking adjustable variables	51
Cleaning the diaphragm rupture sensor	103
Cleaning valves	104
Clear	93
Clear counters	93
Clickwheel	18
Climate	120
Code	93
Compatibility	120
Compensation	63
Concentration	63
Concentration entry	63
Configuration	78
Connector size	115, 116
Contact	26, 53
Contact - adaptive	53
Contact memory	93
Contact water meter	55
continuous	78
Continuous display	19
Continuous displays	51, 170
Contrast	94
Control elements	18
Current output	47, 76
Current stroke volume	52
Curve	56

D

Date	52, 81, 93, 111
Declaration of Conformity	159, 160
Decommissioning	113
Decontamination declaration	16
Degassing	35, 36
Degassing, function	27
Degassing, mA output	76
Degree of protection	120
Demonstration purposes	72
Designation of the product	159

Detailed view	93, 111	Fault messages	106
DFMa	59	Fault statuses	29
Diagrams for Setting the Capacity	156	Faults without a fault message	105
Diaphragm	94	Fill	59
Diaphragm part number	94	Flow	27
Diaphragm replacement	94, 101	Flow control	76
Diaphragm replacement position	94	Flow Control	76
Diaphragm rupture	77	Functions	29
Diaphragm rupture indicator	44	G	
Dielectric constant	78	Gas lock	62
Dimensional drawings	147	General non-discriminatory approach	2
Directly changeable variables	96	H	
Discharge stroke	24, 59	Hardware	52
Discharge valve	37	Hemisphere	81
Display	94	Hierarchy of operating modes	29
Disposal	114	HMI	41
Dosing	45	HMI operating unit	41
Dosing precision	63	HMI version	52
DulcoFlow	59	HV1	60
DulcoFlow®	76	I	
E		Identification of safety notes	10
Electrical data	119	Identifier	19
Electrical installation	39	Identity code	7
Emergency	14	Identity Code	52
Error	29, 74, 109	Information	52
Error log book	93	Information in the event of an emergency	14
Error processing	57	Inputs/outputs	73
Error, mA output	76	Installation, electrical	39
Events	111	Installation, hydraulic	32
Exploded drawings	122	Installing hose lines	33
External contact	29, 42, 43	IP	120
External frequency changer	29	K	
F		Keys	18, 22
Factor	53, 55	L	
Factory settings	94	Language	95
Fast	59	LCD screen	18, 94
Fault	45	Leakage hole	98
FAULT	106	Level	77
Fault indicating and pacing relay	28	Level error	77
Fault indicating relay	28, 46, 47	Level switch	27, 43, 46
Fault indicator	18	Level warning	77
Fault indicator (red)	28	Linear curve	56
Fault Level Niveau	78		
Fault message	19		

Liquid level percent	78	Outgassing	62
Location	81	Outgassing feed chemicals	60
Lock	92	Overview of equipment	17
Log book	93, 109, 110, 111	P	
Log book entries	93	Pacing relay	46, 47
Log book entry	93, 111	Password	51, 93
Lost in hyperspace	49	Pause	27, 29, 42, 77
Lower side band	57	Perc. liquid level	78
M		Performance data	115, 116
mA input	42, 56	Polarity	74
mA output	28, 76	Power consumption	119
Main display	19	Pressure	61
Mains cable	40	Pressure adjustment	72
Maintenance	98	Pressure display	19
Manual	26, 29, 53, 64	Pressure rating	61
Material specifications	118	Pressure unit	72
Maximum capacity	52	Priming	29, 96
Maximum metering rate	52	Priming pressure	36
Memory	53, 55	Priming time	80
Menu	52	Product type	160
Metering	59, 74	Protection against contact and moisture	120
Metering monitor	43, 76	Protection menu	92
Metering profiles	24, 59	Pulse control	55
Metering pumps with degassing	35	Pulses	53
Metering pumps with self-degassing	36	Pump active	45, 74
Metering pumps without integral relief valve	37	Q	
Metering pumps without self-degassing	33	Qualification of personnel	14
Minimum Stroke Length	117	R	
Monitoring	62	Relay	45, 74
N		Relay polarity	46, 75
Nominal pressure	61	Relay type	74
Non-discriminatory approach	2	Relays	28
Normal	60	Relevant directives	159
O		Repair	100
Operating indicator (green)	18, 28	Replacement position	101
Operating menu	164	Replacing the diaphragm	101
Operating modes	29	Replacing the dosing head	72
Operating overview	162	Reproducibility	117
Operation	96	Retrofit kits	146
Optimum	59	Retrofitting Relays	172
Optional	45	Return line	37
Ordering information	146	Return pipe	33, 35, 36
Out-gassing	58		

S	
Safety declaration form	16
Scaling, mA output	76
Scope of Delivery	16
Secondary display	19
Secondary displays	51, 171
SEK	36
SEK dosing head	72
SEK types	26
Select the analogue signal	76
Selecting the operating mode	53
Self-Bleeding	26
Semiconductor switch	46, 47
Sensitivity air detect	62
SER types	26
Serial no.	160
Serial number	52, 159
Service	92
Set time	81
Set up, chapter	52
Set-up overview	162
Setting	49
Setting mode	51
Settings	52
Shipping weight	121
Side band	56, 57, 58
Sleeve	37
Slot	18
Slow	59
Software	52
Sound pressure level	14, 121
Spare parts kit	94
Spare parts kit part number	94
Standard installation	38
Standard signal output	76
Start behaviour	73
Starting a batch	96
Stop	28, 29
Stop, mA output	76
Storage	16
Storage period	90
Stroke counter	93
Stroke length	58
Stroke length, manual	58
Stroke rate	45, 74
Stroke rate since switching on	93, 111
Suction lance	27
Suction lance electrodes	78
Suction lance, continuous	78
Suction stroke	24, 25, 58, 60
Summertime	81
Sunday	81
Supplementary information	2
Supply voltage	40
Switch-off pressure	62
Switch-on counter	52
Switching-on duration	93, 111
Symbols	38
System	71
T	
Technical data	115, 116
Temperature	93, 111
Temperatures	119
Terminals	18
Test (function)	29
Time	52, 93, 111
Timer	81
1 time event - several actions	86
Action	84
Actions	91
Activation	82
active	82
active / inactive	90
Administration functions for commands	83
Change program lines	88
Check program lines ("Show")	87
Clear all	88
Clear individual program lines	88
Clear program lines	88
Clear, all	88
Clearing the program	88
Creating a program	82
Cycle	85
Deactivation	82
Delayer	92
Event	84
Examples	88
Explanation of functions	91
Explanation of selected functions	91
Functional faults	90

Generating commands	82	WARNING	108
inactive	82	Warning indicator	18
Init	85	Warning indicator (amber)	28
Initialisation	91	Warning Level Niveau	78
Inputs	92	Warning message	19, 46
Metering	89	Warning messages	108
new program line	83	Warning sign	10
Outputs	91	Warning, mA output	76
Pitfalls	90	Warnings	110
Power supply	90		
Program line	82		
Program line new	83		
Sequence	87		
set	82		
several actions - 1 time event	86		
Show instruction	87		
Show program line	87		
Sorting criterion	87		
Sorting sequence	87		
Switching time	85		
Time	85		
Time event	84		
Timer information	90		
Trigger	84, 91		
Triggering event	91		
Timer, function	27		
Total metering volume	52		
Total number of strokes	52, 93, 111		
Total operating time	52, 93, 111		
Transport	16		
Troubleshooting	105		
U			
Unit Level	78		
Unpacking	16		
Upper side band	58		
V			
Vent valve	37		
Versions	52		
Viscosity	58, 60		
Volume counter	93		
Volume unit	72		
W			
Warning	45, 74, 110		



ProMinent GmbH
Im Schuhmachergewann 5 - 11
69123 Heidelberg
Germany
Telephone: +49 6221 842-0
Fax: +49 6221 842-419
Email: info@prominent.com
Internet: www.prominent.com

984586, 9, en_GB