





WASTECORP. Pumps®





2022 SLUDGE MASTER® PLUNGER PUMP BROCHURE

PE Series, HPE Series , EHPE Series Since 1928.
Sewage, Sludge and Solids Handling Pumps.

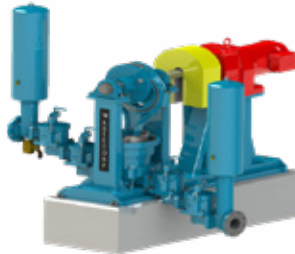
Sludge Master® Plunger Pumps - Range Overview

OVERVIEW	PRODUCT	TECHNICAL SPECIFICATIONS	PAGE										
<ul style="list-style-type: none"> ■ The space saving answer for municipal or industrial sludge transfer ■ Directly replaces double disc, rotary lobe or progressive cavity pumps ■ Several configuration options available 	<p style="text-align: center;">Space Saver™ III Series</p> 	<table border="1" style="width: 100%; border-collapse: collapse;"> <tr> <td style="width: 70%;">Max. capacity</td> <td style="text-align: right;">140 GPM</td> </tr> <tr> <td>Max. rec. suction lift</td> <td style="text-align: right;">20'</td> </tr> <tr> <td>Max. discharge head</td> <td style="text-align: right;">180'</td> </tr> <tr> <td>Plunger dia.</td> <td style="text-align: right;">7"- 11"</td> </tr> <tr> <td>Pump style</td> <td style="text-align: right;">In line piping</td> </tr> </table>	Max. capacity	140 GPM	Max. rec. suction lift	20'	Max. discharge head	180'	Plunger dia.	7"- 11"	Pump style	In line piping	12
Max. capacity	140 GPM												
Max. rec. suction lift	20'												
Max. discharge head	180'												
Plunger dia.	7"- 11"												
Pump style	In line piping												
<ul style="list-style-type: none"> ■ Light- medium duty sewage handling applications ■ Available in belt driven or direct drive configurations ■ A proven design for over 80 years ■ Leak resistant design 	<p style="text-align: center;">PE-741™/61A Series</p> 	<table border="1" style="width: 100%; border-collapse: collapse;"> <tr> <td style="width: 70%;">Max. capacity</td> <td style="text-align: right;">60 GPM</td> </tr> <tr> <td>Max. rec. suction lift</td> <td style="text-align: right;">20'</td> </tr> <tr> <td>Max. discharge head</td> <td style="text-align: right;">100'</td> </tr> <tr> <td>Plunger dia.</td> <td style="text-align: right;">7"</td> </tr> <tr> <td>Pump style</td> <td style="text-align: right;">Simplex</td> </tr> </table>	Max. capacity	60 GPM	Max. rec. suction lift	20'	Max. discharge head	100'	Plunger dia.	7"	Pump style	Simplex	16
Max. capacity	60 GPM												
Max. rec. suction lift	20'												
Max. discharge head	100'												
Plunger dia.	7"												
Pump style	Simplex												
<ul style="list-style-type: none"> ■ Medium - heavy duty pump rating ■ Primary or secondary sludge pumping applications ■ Ideal for municipal wastewater treatment facility digester pumping ■ Replaceable connecting rod insert for saving time and money 	<p style="text-align: center;">PE-941-44™/81-84W™ Series</p> 	<table border="1" style="width: 100%; border-collapse: collapse;"> <tr> <td style="width: 70%;">Max. capacity</td> <td style="text-align: right;">335 GPM</td> </tr> <tr> <td>Max. rec. suction lift</td> <td style="text-align: right;">20'</td> </tr> <tr> <td>Max. discharge head</td> <td style="text-align: right;">180' h</td> </tr> <tr> <td>Plunger dia.</td> <td style="text-align: right;">9"</td> </tr> <tr> <td>Pump style</td> <td style="text-align: right;">Simplex - quadruplex</td> </tr> </table>	Max. capacity	335 GPM	Max. rec. suction lift	20'	Max. discharge head	180' h	Plunger dia.	9"	Pump style	Simplex - quadruplex	18
Max. capacity	335 GPM												
Max. rec. suction lift	20'												
Max. discharge head	180' h												
Plunger dia.	9"												
Pump style	Simplex - quadruplex												
<ul style="list-style-type: none"> ■ Heavy duty pump design ■ Select from premium Siemens or SEW Eurodrive gear boxes ■ Energy saver drive system standard 	<p style="text-align: center;">PE-1141-44™/ 111-114W™ Series</p> 	<table border="1" style="width: 100%; border-collapse: collapse;"> <tr> <td style="width: 70%;">Max. capacity</td> <td style="text-align: right;">495 GPM</td> </tr> <tr> <td>Max. rec. suction lift</td> <td style="text-align: right;">20'</td> </tr> <tr> <td>Max. discharge head</td> <td style="text-align: right;">115'</td> </tr> <tr> <td>Plunger dia.</td> <td style="text-align: right;">11"</td> </tr> <tr> <td>Pump style</td> <td style="text-align: right;">Simplex - quadruplex</td> </tr> </table>	Max. capacity	495 GPM	Max. rec. suction lift	20'	Max. discharge head	115'	Plunger dia.	11"	Pump style	Simplex - quadruplex	20
Max. capacity	495 GPM												
Max. rec. suction lift	20'												
Max. discharge head	115'												
Plunger dia.	11"												
Pump style	Simplex - quadruplex												

Values based on factory tests using water (Sp.Gr.1.0)

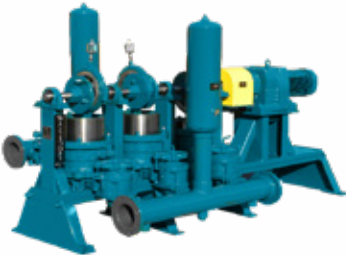
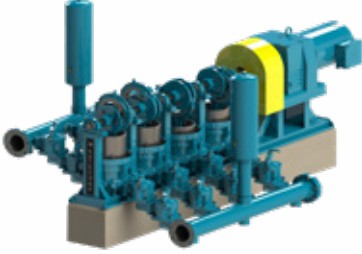
OVERVIEW	PRODUCT	TECHNICAL SPECIFICATIONS	PAGE										
<ul style="list-style-type: none"> ■ Industry's only trailer mounted plunger pump ■ Available with gas or diesel engines ■ Ideal for oil field sludge applications and portable clean-up ■ Choose from simplex or duplex styles 	<p>HPX™ Engine Driven Series</p> 	<table border="1"> <tr> <td>Max. capacity</td> <td>Up to 335 GPM</td> </tr> <tr> <td>Max. rec. suction lift</td> <td>20'</td> </tr> <tr> <td>Max. discharge head</td> <td>180'</td> </tr> <tr> <td>Plunger dia.</td> <td>7"11"</td> </tr> <tr> <td>Pump style</td> <td>Simplex/mobile</td> </tr> </table>	Max. capacity	Up to 335 GPM	Max. rec. suction lift	20'	Max. discharge head	180'	Plunger dia.	7"11"	Pump style	Simplex/mobile	<p>22</p>
Max. capacity	Up to 335 GPM												
Max. rec. suction lift	20'												
Max. discharge head	180'												
Plunger dia.	7"11"												
Pump style	Simplex/mobile												
<ul style="list-style-type: none"> ■ Severe duty sewage pumps ■ Ideal for large urban wastewater treatment plants or sanitary districts ■ Available with a maintenance reducing guided stuffing box system 	<p>HPE-941-44™/81-84™ Series</p> 	<table border="1"> <tr> <td>Max. capacity</td> <td>370 GPM</td> </tr> <tr> <td>Max. rec. suction lift</td> <td>20'</td> </tr> <tr> <td>Max. discharge head</td> <td>240'</td> </tr> <tr> <td>Plunger dia.</td> <td>9"</td> </tr> <tr> <td>Pump style</td> <td>Simplex - quadruplex</td> </tr> </table>	Max. capacity	370 GPM	Max. rec. suction lift	20'	Max. discharge head	240'	Plunger dia.	9"	Pump style	Simplex - quadruplex	<p>25</p>
Max. capacity	370 GPM												
Max. rec. suction lift	20'												
Max. discharge head	240'												
Plunger dia.	9"												
Pump style	Simplex - quadruplex												
<ul style="list-style-type: none"> ■ Severe duty fluid handling ■ For use at college campuses, hospitals, public buildings, prisons and more ■ 11" plunger configuration provides a consistently clog free sewage flow 	<p>HPE-1141-44™/111-114™ Series</p> 	<table border="1"> <tr> <td>Max. capacity</td> <td>560 GPM</td> </tr> <tr> <td>Max. rec. suction lift</td> <td>20'</td> </tr> <tr> <td>Max. discharge head</td> <td>170'</td> </tr> <tr> <td>Plunger dia.</td> <td>11"</td> </tr> <tr> <td>Pump style</td> <td>Simplex - quadruplex</td> </tr> </table>	Max. capacity	560 GPM	Max. rec. suction lift	20'	Max. discharge head	170'	Plunger dia.	11"	Pump style	Simplex - quadruplex	<p>26</p>
Max. capacity	560 GPM												
Max. rec. suction lift	20'												
Max. discharge head	170'												
Plunger dia.	11"												
Pump style	Simplex - quadruplex												
<ul style="list-style-type: none"> ■ Extra heavy duty pump design ■ Designed for higher discharge head applications up to 300 ft. ■ Specified for Army, Naval base sewage handling operations and more 	<p>EHPE™ Series</p> 	<table border="1"> <tr> <td>Max. capacity</td> <td>370 GPM</td> </tr> <tr> <td>Max. rec. suction lift</td> <td>20'</td> </tr> <tr> <td>Max. discharge head</td> <td>300'</td> </tr> <tr> <td>Plunger dia.</td> <td>9"</td> </tr> <tr> <td>Pump style</td> <td>Duplex - Quadruplex</td> </tr> </table>	Max. capacity	370 GPM	Max. rec. suction lift	20'	Max. discharge head	300'	Plunger dia.	9"	Pump style	Duplex - Quadruplex	<p>28</p>
Max. capacity	370 GPM												
Max. rec. suction lift	20'												
Max. discharge head	300'												
Plunger dia.	9"												
Pump style	Duplex - Quadruplex												

Values based on factory tests using water (Sp.Gr.1.0)



Wastecorp Plunger Pump Applications

Municipal

- Aluminum sludge
- Belt filter press feed
- Blended sludge
- Centrifuge recirculation
- Digester recirculation
- Digested sludge
- GBT thickener feed
- Lime sludge
- Lime slurry
- Mobile dewatering
- Primary sludge
- Primary Treatment
- Rotary press feed
- Septage
- Thickened sludge
- Truck loading/unloading
- Waste activated sludge

Industrial

- Cannery wastes
- Chemical fillers
- Chicken process waste
- Chocolate waste
- clay slurry
- coal slurry
- Distillation mashers
- Explosive jelly
- Ferric chloride
- Fleshings
- Fiberboard filler
- Fish packing
- Food waste slurry
- Gum and chicle slurry
- Hog fat
- Holding tank transfer
- Lagoon cleaning pump
- Locomotive tanker pumping
- Meat packing waste
- Metal slurry pump
- Oil sludge
- Polymer transfer
- Pharmaceutical waste
- Pulp and paper stock pumps
- Refinery waste
- Sampling pump set
- Sealing compounds
- Settled oil solids
- Ship bilge transfer
- Sludge recovery
- Sump pumping
- Tannery waste
- Textile and dye waste
- Vacuum filter feed pump



Plunger Pumps Manufactured With High Quality Components

- S.E.W. Eurodrive® or Siemens® gear reducers available
- Ashcroft® pressure & compound gauges (optional)
- Danfoss® variable frequency drives (optional)
- 160,000 PSI ground & polished shaft material
- Castings manufactured of cast iron classification ASTM A48; Class 30-40 (ductile iron also available)
- Wastecorp Plunger Pac™ leak-prevention system V-Type packing (optional)
- Automatic oiler systems
- Quick opening sampling valves
- Superior replaceable connecting rod bearing standard



The Proven Sewage & Sludge Pumping Technology for 80 Years



The original PE, HPE & EHPE Series plunger pump factory and team members Ridgewood, NJ 1928.

Wastecorp Plunger Pumps are positive displacement pumps, which use a plunger to force liquid from the suction side to the discharge side of the pump. Plunger pumps primarily pump municipal and industrial sewage.

With a selection of over 100 models, Wastecorp Plunger Pumps are specified to move heavy sludge or heavy viscous materials containing solids up to 18%. Plunger Pumps operate essentially clog free because the pulsating motion of the plunger breaks up potential blockages. All plunger pump series are self-priming and capable of handling suction lifts up to 25 ft.

Sectionalized Construction for Easy & Low Life Cycle Cost Maintenance

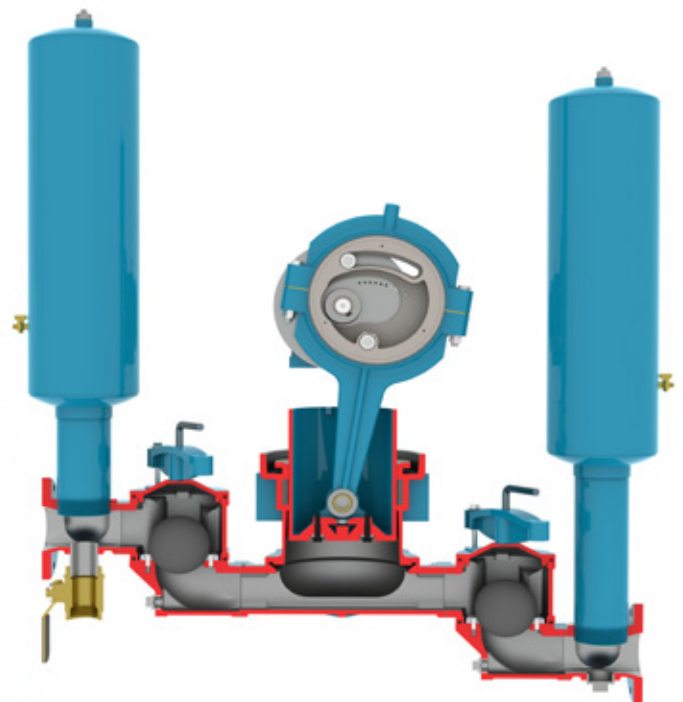

Compare Sewage Pumps



Plunger Pumps vs. Progressing Cavity Style Pumps

- Plunger pumps can operate dry, while most progressing cavity pumps cannot.
- Plunger pumps do not require a relief valve as a standard component, whereas, many progressing cavity pumps require them.
- Capacity variation by means of single pin position adjustment, whereas, adjusting a progressing cavity pump usually requires a separate variable speed unit.
- Plunger pumps have a substantially lower maintenance cost over progressing cavity type pumps on a life cycle basis.
- Wastecorp plunger pumps models have high solids handling ability exceeding 1½" spherical solids.
- Progressing cavity pump size will often determine solids handling capability .08" - 1½".
- Typically, plunger pumps have considerably less downtime on a life-cycle basis.

Plunger Pumps vs. Rotary Lobe Style Pumps

- Most plunger pump parts are exposed for easy inspection and maintenance, whereas, rotary lobe pumps are enclosed in a casing making maintenance difficult.
- Plunger pump flow rate is adjusted by pin position, whereas, few rotary lobes' have any means of altering flow rate.
- Plunger pumps are equipped with an internal overload protection by means of an eccentric shear pin, whereas most rotary lobes have no internal pump shutdown device.
- Plunger pumps are manufactured with large orifices, which pass larger solids and stringy materials without clogging.
- Larger solids and stringy materials may damage or clog winding rotary lobe rotors.



Plunger Pumps vs. Double Disc Pumps (Traditional Models Only)

- Plunger pumps' check valve design provides superior sealing characteristics over double disc flapper valves.
- Plunger pumps are capable of up to 300 ft. discharge head, whereas double disc are mostly limited to 100 ft.
- Unlike most double disc pumps, Wastecorp Plunger pump models will pass the same amount of high solids through its system regardless of pump size.
- The average life cycle of a plunger is 8-15 years, whereas, a disc will typically only last 3-5 years.
- The modern reality of wastewater sewage treatment is that facilities are pumping more with less of a budget. Plunger pumps are better suited to meet the challenges of this new reality.

Sludge Master® Plunger Pump Technology - THE FACTS

- ✓ Wastecorp PE, HPE, EHPE Series are the longest serving plunger pumps of any manufacturer.
- ✓ Wastecorp serves over 18,000 plunger pump installation, more than any competitor.
- ✓ Wastecorp offers the industry's only 160,000 psi strength shafts.
- ✓ Wastecorp castings are available in class 40 cast iron or ductile iron.
- ✓ Wastecorp has replaced hundreds of rotary lobe, double disc and progressive cavity pumps that have

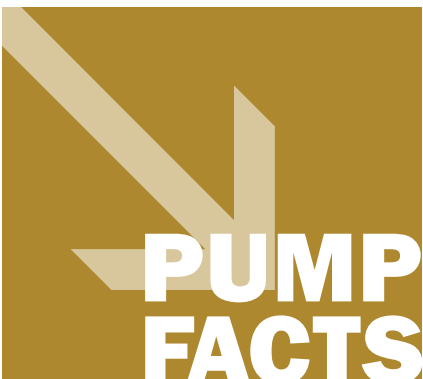

- Plunger pumps are a preferred heavy sewage pumping technology compared to rotary lobe pumps, progressive cavity pumps and double disc pumps.
- Sludge Master Plunger Pumps are available with leak prevention system technology, providing a 40% stronger seal.

WHY A SLUDGE MASTER PLUNGER PUMP?



HIGHER GRADE CAST IRON

Sludge Master castings hold a cast iron classification of ASTM A48; Class 30-40. This translates to longer lasting pump components and lower maintenance. Some castings are also available in class A536 grade 60-40-18/65-45-12 ductile iron.

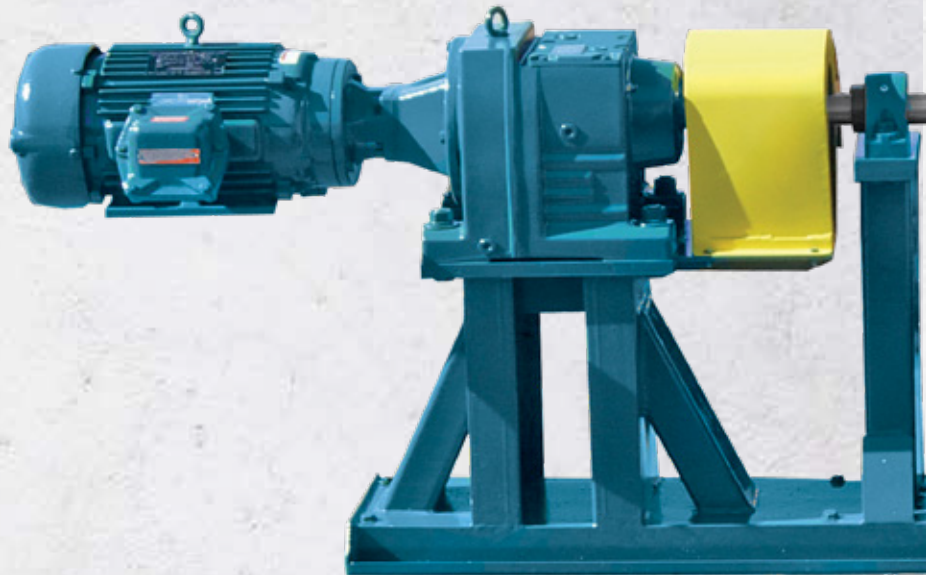

HIGH TENSILE STRENGTH SHAFTS

Stronger 160,000 PSI strength shafts is one more feature that separates Sludge Master Plunger Pumps from the crowd. Stronger shafts reduce stress on other components like the flange and eccentric.

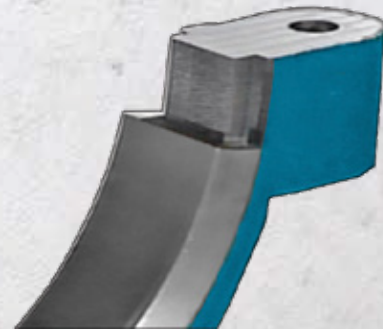

REPLACEABLE ECCENTRIC LINER

Wastecorp pioneered the replaceable connecting rod insert now standard on all models. Replace only the insert instead of the entire connecting rod.

ISO 9001 CERTIFIED PLUNGER PUMP MANUFACTURER

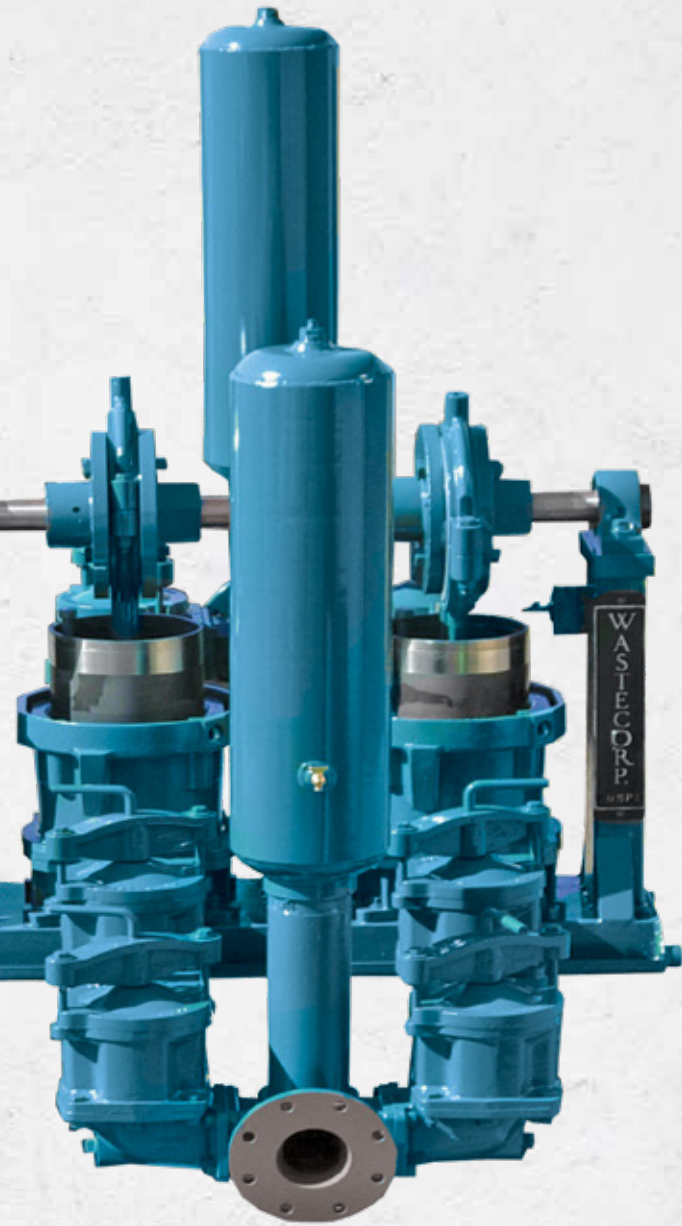

THE NEXT GENERATION QUALITY

From replaceable connecting rod inserts to energy saving drive systems, you get more from Sludge Master Plunger Pumps. Wastecorp invests hundreds of engineering hours every year to advance our industry leading design. And, with a Wastecorp Plunger pump you get our commitment to protecting the environment and saving energy with our low emission drive systems.

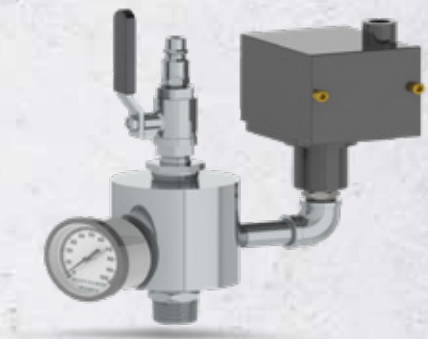

RUN DRY PROTECTION*

Be sure to specify Wastecorp's pressure sensor assembly with your plunger pumps to protect against dead heading, closed valves in the system and unexpected objects in the suction line.

Our gauges monitor operating pressure and feature a built in, field adjustable shut off switch. Ask your Wastecorp representative for more information.

PIPED IN TO YOUR NEEDS

Wastecorp's factory piping can reduce the amount of fluid around your plunger pump. We pipe the stuffing box (s) and the base so waste goes down the drain and keeps the area around the pump clean.



Plunger Pump Materials of Construction

Pump Component	Standard Material	Optional materials
Main shaft	A4140/4142 high-strength alloy steel	
Eccentric	ASTM A48, Class 35 Close-grained grey iron	44W steel
Eccentric lubrication	Manual sight feed oiler, 5 oz	a) Automatic ball-type oiler with needle valve b) electric solenoid oiler, c) mechanical force feed lubricator
Driven/drive flanges	ASTM A48, Class 35 Close-grained Grey Iron	
Connecting rod	ASTM A536, GR 65-45-12 ductile iron	
Eccentric bearing liner	Replaceable, bronze insert	
Bushing, wrist pin	SAE 941 oil-lite bronze	
Wrist pin	A4140/4142 high-strength alloy steel	
Valve seat	ASTM A48, Class 30 close-grained grey iron	Bronze nickel alloy 316 stainless steel
Ball valve	5-1/8" urethane rubber with centralized iron core	
Plunger	ASTM A536, GR 65-45-12 ductile iron polished to RMS 32 finish	Coatings available: a) hard chrome plated, b) chrome oxide, c) aluminum oxide, d) tungsten carbide, e) stainless steel
Pump body	ASTM A48, Class 35 close-grained grey iron	
Stuffing box	ASTM A48, Class 35 close-grained grey iron	Guided stuffing box assembly
Gland	ASTM A48, Class 35 close-grained grey iron	
Flange connection	4" ANSI 125 lb (simplex and duplex pumps) 6" ANSI 150 lb (triplex and quadruplex pumps)	Optional camlocks
Air chamber	A53 seamless steel pipe, anodized with 1/4" brass petcock	Stainless steel
Packing	1/2" sq. kevlar braided with poly-urethane seal	a) Graphite rings only, b) Chevron rings only, c) Plunger Pac (chevron, Teflon and poly-urethane seal)
Pump base	Fabricated heavy-duty steel channel and tube base plate and pedestals with drip gutters and 1" drain connections	
Drive arrangement	Constant speed, helical gear motor coupled to pump's main shaft, max. output speed: 50 RPM	a) V-Belt/gear/pulley system, b) mechanical variable speed drives, c) variable frequency drives, d) Others – contact Wastecorp
Drive coupling	Flexible grid-type	a) Disc coupling, b) elastomer coupling, c) others – contact Wastecorp

Optional Accessories

- Six figure revolution counter
- Pressure gauge with diaphragm seal
- Compound gauge with diaphragm seal
- Pressure indicating switch to shut pump down
- Pressure relief valves (with or without by-pass piping)
- Capped hose end valve
- Dual ball valve assembly

Notes:

1. Consult factory for updated materials of construction list for your project. Upgrades to materials made on a continuous basis.

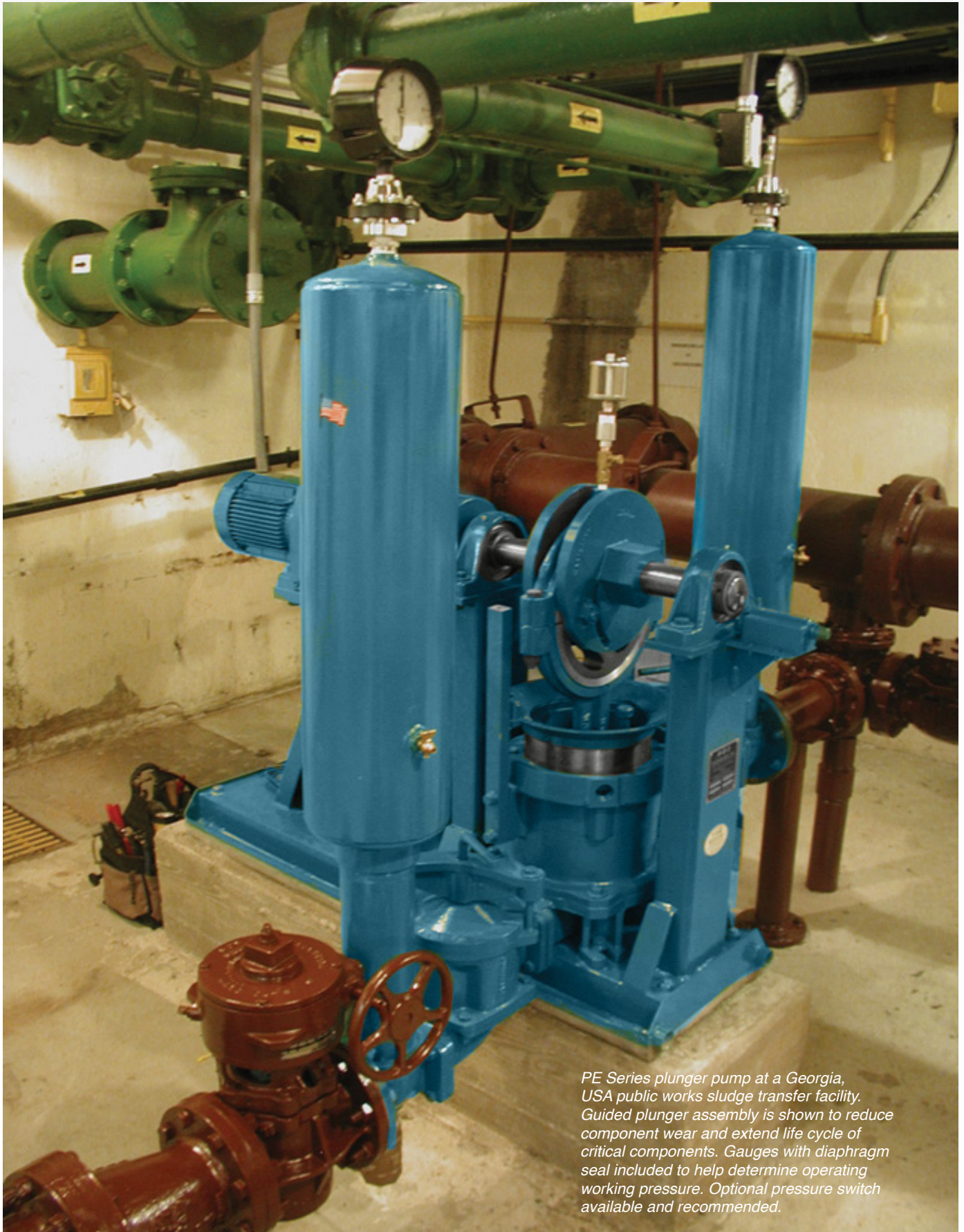

PE Series plunger pump at a Georgia, USA public works sludge transfer facility. Guided plunger assembly is shown to reduce component wear and extend life cycle of critical components. Gauges with diaphragm seal included to help determine operating working pressure. Optional pressure switch available and recommended.

Sludge Master® Plunger Pumps Space Saver™ Series



The Space Saver plunger pump features a compact integrated steel frame with a uni-construction steel base. This feature eliminates the need for a structural concrete pad.

Applications

- Municipal or industrial sewage transfer applications where space is an issue
- Replaces costly rotary lobe, double disc or progressive cavity pumps with few or no piping changes

Benefits

- At widest point measures less than 16"
- Available with 7", 9" or 11" plungers
- No concrete pad required

- Pump up to 247 GPM at 180 ft. of discharge head
- A variety of configurations available for even the tightest spaces

Recommended Spare Parts

Ball valve (urethane)	33956-00
Plunger*	Model specific
Valve seat**	36022-02
Packing	Select style

* Several coating options available. See page 34 for more.
 ** Available in cast iron, bronze and stainless steel

General Specifications	Simplex PE-7SS	Simplex PE-941-SS-III	Duplex PE-942-SS-III	Simplex PE-1141-SS-III	Duplex PE-1142-SS-III
Number of plungers	1	1	2	1	2
Plunger dia. (in)	7	9	9	11	11
Air chambers	(1) 9"x30"				
Flanged connections	4" ANSI 125 #				
Driver speed, RPM	1800				
Max. strokes per min.	50-62	50	50	50	50
Max. stroke length (in)	5.75	6.56	6.56	6.56	6.56
Max. total head (ft)	100	180	180	115	115
Max. suction lift (ft)	20'				
Max. capacity (GPM)	60	100	170	140	247
Eccentric dia. (in)	8	10	10	10	10
Eccentric shaft tensile strength (PSI)	160,000				
Approx. weight (lbs)	400	1200	1900	1250	1800



Space Saver's transferring sewage at a Knoxville, Tennessee sanitary district plant. With no base requirements, your Space Saver plunger pump options are almost endless.



This Space Saver in Washington State replaced an existing double disc pump installation. No piping changes were needed because the pump configuration is similar.



Wastecorp PE-941 Series at a Palm Beach County, Florida wastewater treatment plant. The PE-941 Series is one of the most popular plunger pump makes to replace rotary lobe and progressive cavity pumps.



Sludge Master® Plunger Pumps PE-741™ | 61™ Series



Wastecorp PE-741 SS Series shown at a meat packing facility. Pump shown with optional piped in stuffing box and pump base in white pvc (additional colors and materials available).

Applications

- Lighter duty primary sludge handling at sewage treatment facilities
- Medium duty industrial applications including poultry, tanneries, canneries and meat processing facilities

Benefits

- Transfer up to 60 gpm of sewage at up to 100 ft. of head
- Belt driven or direct drive systems available
- Leak resistant design with Plunger Pac™ standard

General Specifications	Simplex PE-61A/PE-741
Number of plungers	1
Plunger dia. (in)	7
Air chambers	(2) 9"x30"
Flanged connections	4" ANSI 125 #
Driver speed, RPM	1800
Number of pin positions	12
Max. strokes per min.	42 or 62
Max. stroke length (in)	5.75
Max. suction lift (ft)	20
Max. total head (ft)	100
Max. capacity (GPM)	60
Eccentric dia. (in)	8
Eccentric shaft tensile strength (PSI)	160,000
Approx. weight less driver (lbs)	750

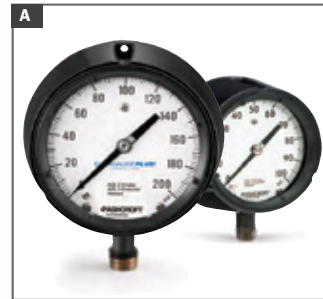

Accessories

A	Pressure and compound gauge	Call
---	-----------------------------	------

Recommended Spare Parts

Main gear (belt driven)	26972-02
Connecting rod insert	52001-04
Plunger	20937-14
Ball valve (urethane)	33956-00
Packing	Select style
Pinion gear	26971-04
Complete gasket kit	Call

Optional Equipment for High Performance Pumping

Dual Ball Valve Assembly

The answer for high solids handling facilities

The dual ball valve assembly is an ideal choice for facilities pumping over 18% solids. The dual ball valve design improves flow by 10% while transferring the toughest municipal and industrial sludge. This assembly is available for all Wastecorp Plunger Pump Series.



Automatic Oiler System

The ultimate oilers for reduced maintenance

When selecting the oiler system for your new plunger pump, consider your options. Our electric oiler systems feature single feed, up to six feed models with various reservoir sizes. Wastecorp's electric solenoid oiler systems, feature up to nine feed systems complete with tubing, 110v (also available in 230/460v) and all tubing and fittings. Our chemical force feed oilers offer the least maintenance hours.

Shown right: HPE Series installed in an Ohio wastewater treatment plant.



Guided Stuffing Box Assembly

Engineered for plunger and packing wear resistance

The guided stuffing assembly absorbs the thrust load from the eccentric motion ensuring that the plunger remains stable through the entire stroke motion.

The plunger guide is the primary guiding force, preventing side load and plunger shift. Wastecorp also employs full length guide bar rollers that capture the entire stroke length of the plunger. Tolerances are set to Wastecorp's 0.0015" nom. No lubrication is required, allowing the roller bearings to last up to 200 times longer than conventional guide shoes and greatly extending packing and plunger life. This feature is available on all new plunger pump models or as a retrofit package for any make.



Sludge Master® Plunger Pumps PE 941-944™ Series (Direct Drive) PE 81-84™ Series (Belt Driven)

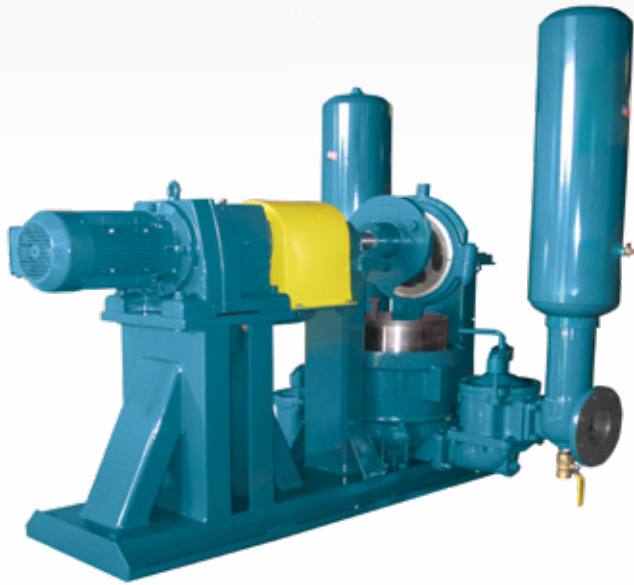

The PE Series features the ultimate in heavy duty components designed for a long life cycle. With heavy duty bearings, Class 40 castings and 160,000 psi strength shafts no other sewage pump

While every pump needs to be maintained, Wastecorp makes the process easier. For connecting rod service, you no longer have to replace the entire rod. Simply replace the liner for less



Applications

- Medium-heavy duty primary and secondary sludge transfer
- Used by sewage treatment plants, prisons, public utilities and industry for nearly 80 years

Benefits

- Pumping capabilities up to 335 GPM at 180 ft. of head
- Available with the guided stuffing box system to extend component life up to 40% (see page 17)

- 7 ½ lb urethane rubber balls, 5 1/8" diameter to break apart heavy sewage
- Adjustable & recessed packing gland
- 1" or 2" bronze quick-opening sampling valve on pump discharge side
- Manual, sight feed oiler, 5 oz. capacity

General Specifications	Simplex PE-81W/PE-941	Duplex PE-82W/PE-942	Triplex PE-83W/PE-943	Quadruplex PE-84W/PE-944
Number of plungers	1	2	3	4
Plunger dia. (in)	9			
Air chambers	(2) 9"x30"			
Flanged connections	4" ANSI 125 #	4" ANSI 125 #	6" ANSI 150 #	6" ANSI 150 #
Driver speed, RPM	1800			
Number of pin positions	11			
Max. strokes per min.	50			
Max. stroke length (in)	6.56			
Max. suction lift (ft)	20			
Max. total head (ft)	180			125
Max. capacity (GPM)	88	170	252	335
Eccentric dia. (in)	10			
Eccentric shaft tensile strength	160,000			
Approx. weight less driver (lbs)	1200	1900	2650	3400



Wastecorp PE 941 plunger installation at a northern California wastewater treatment plant. Wastecorp offers start-up and staff training services from the factory or our worldwide dealer network.

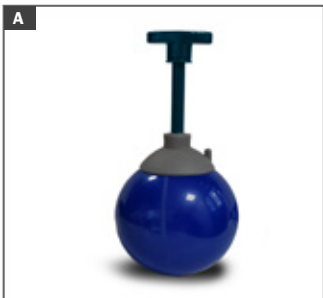

Ball valve extraction tool



The Packing Puller™

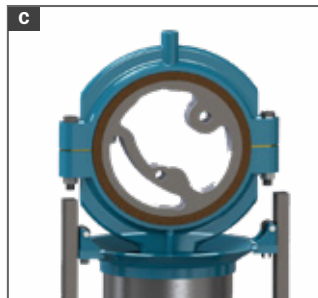

Guided stuffing box assembly



Electric solenoid automatic oiler system

Accessories

A	Ball valve extraction tool	65891-00
B	The Packing Puller™	61040-00
C	Guided stuffing box assembly	99954-00
D	Automatic oiler system	40263-00

Recommended Spare Parts

Plunger 9"	15041-14
Ball valve	33956-00
Plunger Pac™ packing	42687-00
Connecting rod/insert bearing	46726-04
Valve seat, CI	36022-02
Complete gasket kit	Call

* Several coating options available. See page x for more.

Sludge Master® Plunger Pumps PE 1141-1144™ Series (Direct Drive) PE 111W-114W™ Series (Belt Driven)

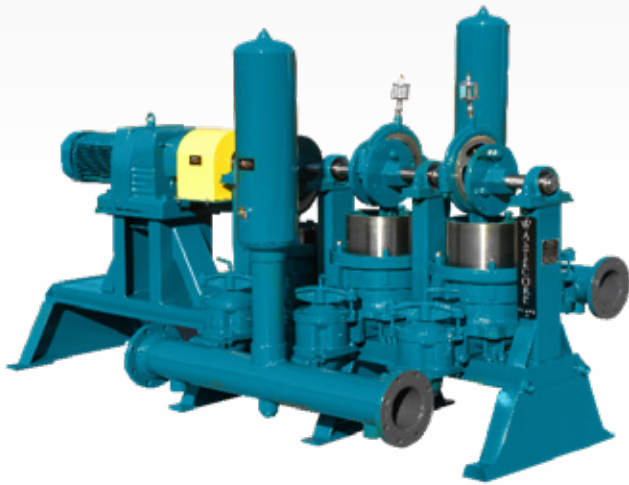

The ultimate in performance and ease of maintenance. The 11" PE-1141 Series is a favorite among maintenance crews throughout North American wastewater treatment facilities.

Applications

- Heavy duty sewage pumping applications

Benefits

- Pumping capabilities up to 495 GPM at 115 ft. of head.
- Available with the guided stuffing box system to extend component life up to 40% (see page 17)
- This series features an 11" plunger for higher volume applications

- Energy saver drive systems standard
- Premium gear box selection from either Siemens or SEW Eurodrive

Recommended Spare Parts

Plunger* 11"	15338-14
Ball valve (urethane)	33956-00
Wastecorp Plunger Pac™ Packing	42688-00
Connecting rod/insert bearing	46726-04

* Several coating options available. See page 32 for more.

General Specifications	Simplex PE-111W/PE-1141	Duplex PE-112W/PE-1142	Triplex PE-113W/PE-1143	Quadruplex PE-114W/PE-1144
Number of plungers	1	2	3	4
Plunger dia. (in)	11			
Air chambers	(2) 9"x30"			
Flanged connections	4" ANSI 125 #	4" ANSI 125 #	6" ANSI 150 #	6" ANSI 150 #
Driver speed, RPM	1800 (direct drive)			
Number of pin positions	11			
Max. strokes per min.	50			
Max. stroke length (in)	6.56			
Max. rec. suction lift (ft)	20			
Max. total head (ft)	115	115	115	85
Max. capacity (GPM)	136	247	371	495
Eccentric dia. (in)	10			
Eccentric shaft tensile strength	160,000			
Approx. weight less driver (lbs)	1250	2000	2800	3600



Sludge Master PE 941 Plunger Pump shown at a Wastewater treatment plant expansion in New England. On the suction side is a macerator in green. Wastecorp recommends a grinder or macerator placed on the suction side of new pump installations.

Sludge Master® Plunger Pumps Trailer Mounted Series

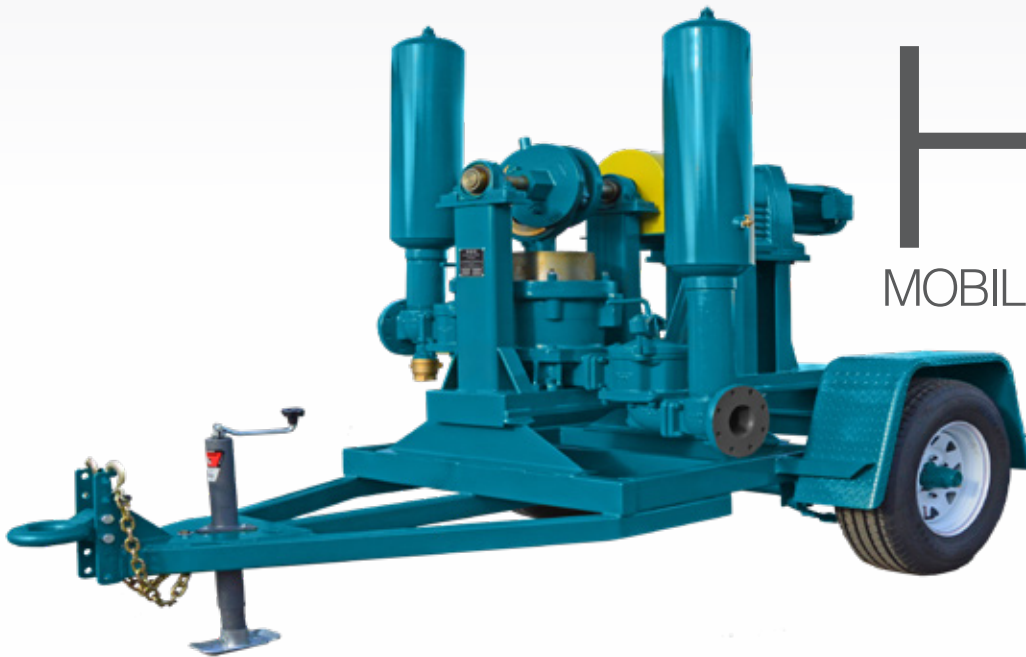

HPX™

MOBILE SLUDGE PUMPS

Take Your Plunger Pump Where Others Won't Go.

The severe duty Wastecorp HPX trailer mounted plunger pump series takes the ultimate sludge fighter anywhere tough sludge needs to be pumped. From oil field applications to municipal sewage clean ups and beyond, Wastecorp's mobile plunger pumps can't be beat for low cost of ownership and years of service.

This configuration is available on all PE and HPE Series simplex pump models with either gasoline or diesel engines. Automatic start feature is also available.

Standard Trailer Mounted Plunger Pump

- 4" ANSI 125 # suction & discharge flange connections (camlocks available).
- 2" bronze quick opening sampling valve.
- Replaceable eccentric bearing liner.
- Choose from belt driven or direct drive models.
- Optional DOT highway package available.



Accessories

A	DOT compliant lighting package	Call
B	Non-collapsible suction/ discharge hose	Call

* Premium non-collapsible suction hose assemblies include aluminum camlock fittings. Contact factory for desired length.



Shown: Sludge Master HPX Series trailer mounted plunger pump. Includes industrial rated off road trailer with electric motor (diesel engine optional). This heavy duty mobile sludge pump pumps out digesters and lagoons around the WWTP.

Sludge Master® Plunger Pumps HPE 81-84™ Series (Belt Driven)

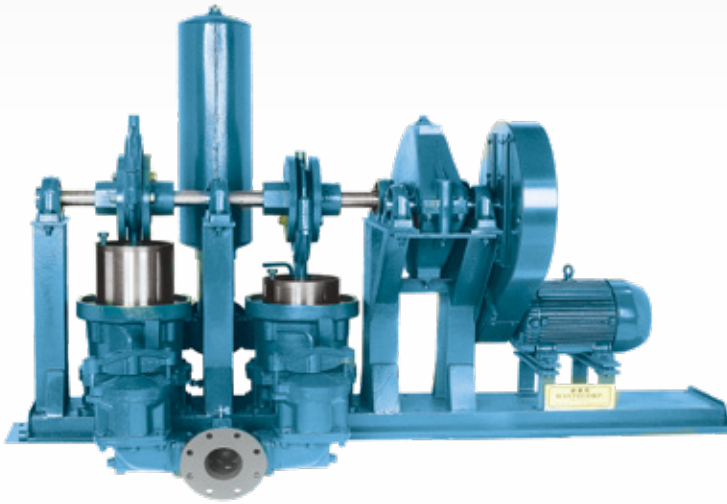

Applications

- Heavy duty sludge transfer applications
- Oil and refinery sludge
- Large urban wastewater sewage treatment facilities and sanitation district digester pumps

Benefits

- Pumping capabilities up to 370 GPM at 140 ft. of head
- Available with optional guided stuffing box system to extend component life up to 40% (see page 17)
- This series features an 9” plunger for higher volume applications
- Energy saver drive systems standard

Recommended Spare Parts

Plunger 9”*	15041-14
Ball valve	33956-00
Bushing, wrist pin (bronze)	15376-00
Connecting rod insert bearing (bronze)	46726-04
Main gear	25552-04
Complete gasket kit	Call
Valve seat**	36022-02

* Several coating options available.

General Specifications	Simplex HPE-81W	Duplex HPE-82W	Triplex HPE-83W	Quadruplex HPE-84W
Number of plungers	1	2	3	4
Plunger dia. (in)	9			
Air chambers	(2) 9”x30”			
Flanged connections	4” ANSI 125 #	4” ANSI 125 #	6” ANSI 150 #	6” ANSI 150#
Driver speed, RPM	1200 (belt driven)			
Number of pin positions	11			
Max. strokes per min.	50			
Max. stroke length (in)	7.25			
Max. suction lift (ft)	20			
Max. total head (ft)	240	240	180	140
Max. capacity (GPM)	95	187	278	370
Eccentric dia. (in)	12			
Eccentric shaft tensile strength	160,000			
Approx. weight less driver (lbs)	1250	2000	2800	3600

Sludge Master® Plunger Pumps HPE 941-944™ Series (Direct Drive)



Applications

- Heavy duty sewage treatment applications
- Belt filter press feed pumps
- Digester circulation

Benefits

- Pumping capabilities up to 370 GPM at 240 ft. of head
- A4142 high strength alloy main shaft
- 4" ANSI 125 # flanged suction and discharge (simplex-duplex)
- 6" ANSI 150 # flanged suction and discharge (triplex-quadruplex)
- Energy saver drive systems standard
- Various lubrication options

Recommended Spare Parts

Plunger 9"*	15041-14
Ball valve	33956-00
Bushing, wrist pin (bronze)	15376-00
Connecting rod insert bearing (bronze)	46726-04
Main gear	25552-04
Complete gasket kit	Call
Valve seat**	36022-02

* Several coating options available. .

General Specifications	Simplex HPE-941	Duplex HPE-942	Triplex HPE-943	Quadruplex HPE-944
Number of plungers	1	2	3	4
Plunger dia. (in)	9			
Air chambers	(2) 9"x30"			
Flanged connections	4" ANSI 125 #	4" ANSI 125 #	6" ANSI 125 #	6" ANSI 125 #
Driver speed, RPM	1800			
Number of pin positions	11			
Max. strokes per min.	50			
Max. stroke length (in)	7.25			
Max. suction lift (ft)	20			
Max. total head (ft)	240			
Max. capacity (GPM)	95	187	278	378
Eccentric dia. (in)	12			
Eccentric shaft tensile strength	160,000			
Approx. weight less driver (lbs)	1255	1920	2650	3465

Sludge Master® Plunger Pumps HPE 1141-1144™ Series (Direct Drive) HPE 111W-114W™ Series (Belt Driven)

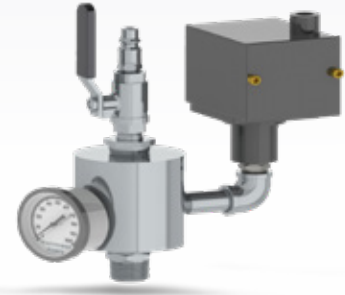

Provides optional safe protection against dead heading, closed valves or other discharge blockages that can damage the pump. Also permits direct charging of pulsation dampener and access for cleaning.

Applications

- Severe duty sewage transfer
- College campus sewage treatment, prisons, pump house, government buildings, industrial sludge, truck and tanker loading

Benefits

- Pumping capabilities up to 600 GPM at 170 ft. of head
- Available with optional guided stuffing box system to extend component life up to 40%

- 7 ½ lb urethane rubber balls, with steel core to break apart heavy sewage
- 11” plunger system
- 2” bronze quick-opening sampling valve on pump discharge side
- Optional mechanical force feed lubricators

General Specifications	Simplex HPE-111W/HPE-1141	Duplex HPE-112W/HPE-1142	Triplex HPE-113W/HPE-1143	Quadruplex HPE-114W/HPE-1144
Number of plungers	1	2	3	4
Plunger dia. (in)	11			
Air chambers	(2) 9”x30”			
Flanged connections	4” ANSI 125 #	4” ANSI 125 #	6” ANSI 150 #	6” ANSI 150#
Driver speed, RPM	1800 (Direct Drive)			
Number of pin positions	11			
Max. strokes per min.	50			
Max. stroke length (in)	7.25			
Max. suction lift (ft)	20			
Max. total head (ft)	170	170	130	95
Max. capacity (GPM)	142	280	418	556
Eccentric dia. (in)	12			
Eccentric shaft tensile strength	160,000			
Approx. weight less driver (lbs)	1450	2400	3600	4400



Wastecorp HPE 1142 plunger pump at an upstate New York sewage treatment facility. This facility has used plunger pumps for their primary sewage process for over 40 years. This new pump is a direct replacement.

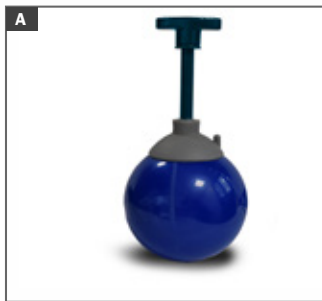

Ball valve lifting tongs pound gauges

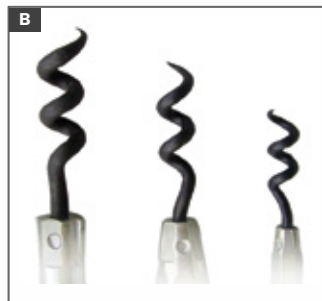

The Packing Puller™

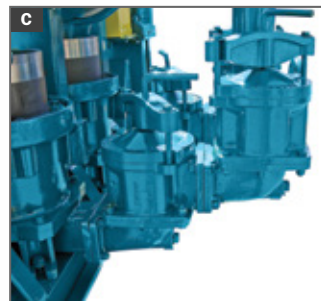

Dual ball valve assembly



Pressure and com-

Accessories | Configuration Options

A	Ball valve extraction tool	65891-00
B	The Packing Puller™	61040-00
C	Dual ball valve assembly	999AC-00
D	Gauges	Various models

Recommended Spare Parts

Index shear pin	50794-00
Ball valve	33956-00
Bushing, wrist pin (bronze)	15376-00
Connecting rod insert bearing (bronze)	52003-04
Plunger 11 ^{1/2} *	15338-14
Complete gasket kit	Call
Valve seat**	36022-02

* Several coating options available. See page 34 for more.

Sludge Master® EHPE™ Series (Extra Heavy Duty)

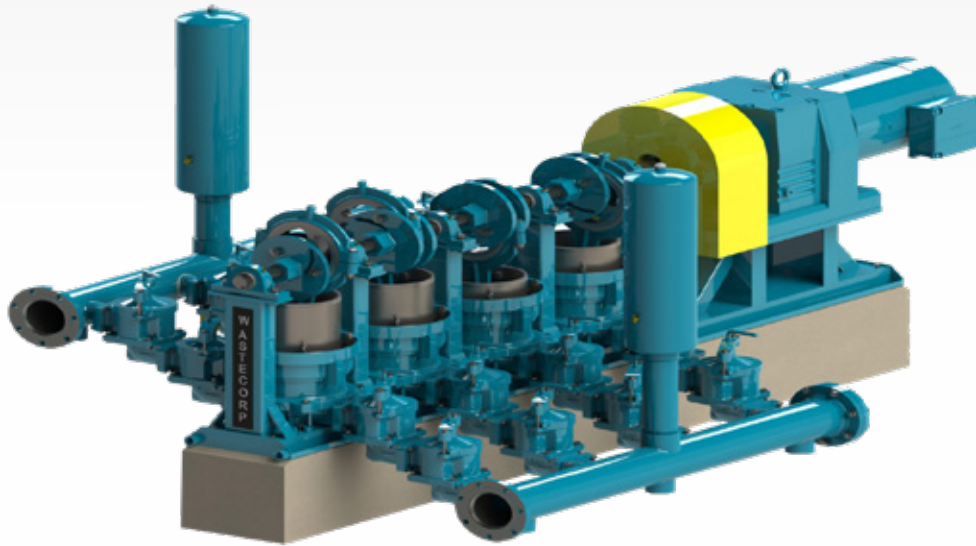

Applications

- Designed for high sludge discharge head applications
- Specified for Army, Navy base and Air force pumping applications and many more applications

Benefits

- Pumping capabilities up to 370 GPM at 240 ft. of head

- Available with the guided stuffing box system to extend component life up to 40%
- 7 ½ lb urethane rubber balls, with steel core to break apart heavy sewage
- 9” plunger system
- 2” bronze quick-opening sampling valve on pump discharge side

General Specifications	Duplex EHPE-942	Triplex EHPE-943	Quadruplex EHPE-944
Number of plungers	2	3	4
Plunger dia. (in)	9		
Air chambers	(2) 9”x30”		
Flanged connections	4” ANSI 125 #	6” ANSI 150 #	6” ANSI 150 #
Driver speed, RPM	1800 (Direct Drive)		
Number of pin positions	11		
Max. strokes per min.	45		
Max. stroke length (in)	7.25		
Max. suction lift (ft)	20		
Max. total head (ft)	240		
Max. capacity (GPM)	187	278	370
Eccentric dia. (in)	12		
Eccentric shaft tensile strength (PSI)	160,000		



Wastecorp EHPE Series installed at a City of Edmonton, Alberta Canada wastewater treatment facility. Wastecorp installed eight plunger pumps at the facility as part of a multi-year upgrade/expansion.

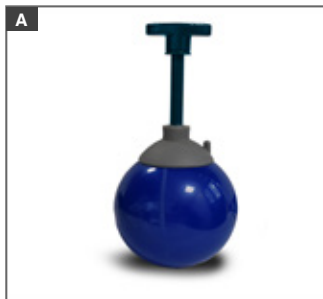

Ball valve extraction tool



The Packing Puller™

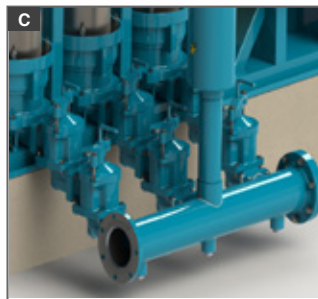

Dual ball valve assembly

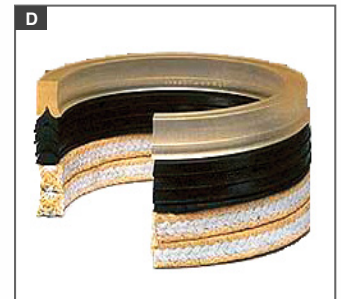

Wastecorp Plunger Pac™

Accessories | Configuration Options

A	Ball valve extraction tool	65891-00
B	The Packing Puller™	61040-00
C	Guided stuffing box assembly	Call
D	Wastecorp combination Plunger Pac	42687-00

Recommended Spare Parts

Index shear pin	50794-00
Ball valve	33956-00
Bushing (bronze)	15376-00
Connecting insert	46726-04
Plunger 9**	15041-14

* Several coating options available.

** Available in cast iron, bronze and stainless steel.

Plunger Pump Packing Options

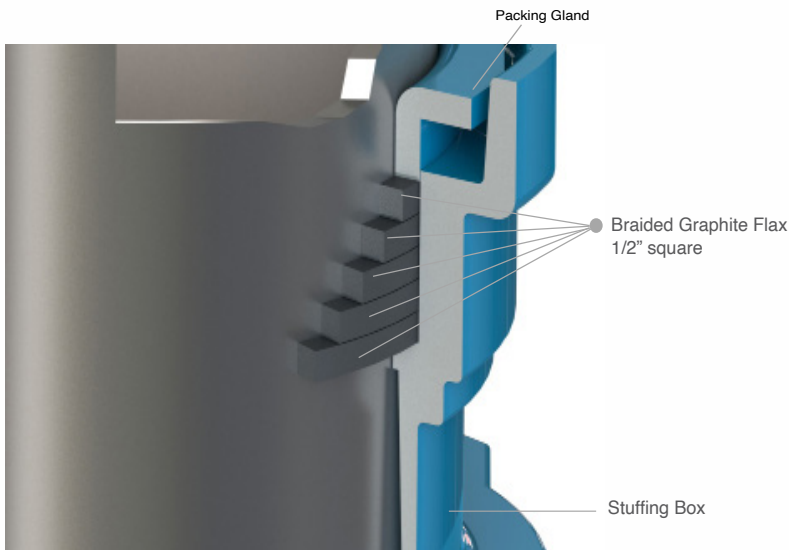
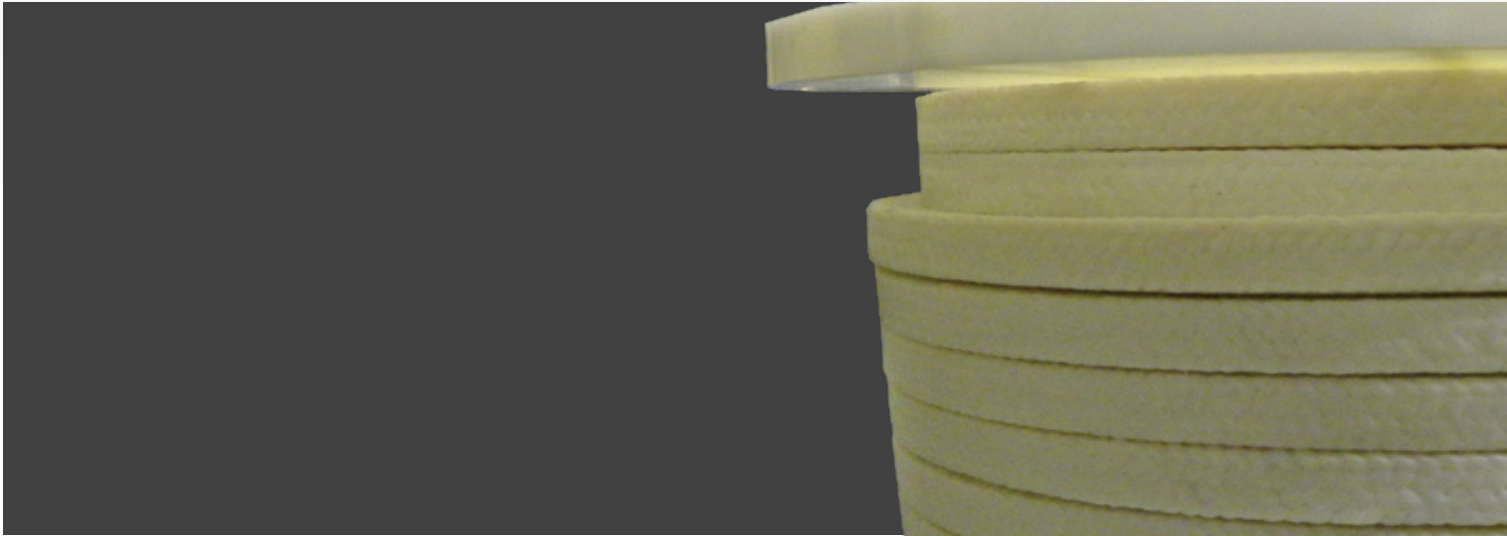

Wastecorp Graphite Flax Packing

Cost effective graphite braided filament packing impregnated with graphite dispersion. Excellent chemical resistance. An ideal packing for low grit applications and provides good heat conduction.

Sizes

4 Rings	25671-00
5 Rings	24914-00
5 Rings	25779-00

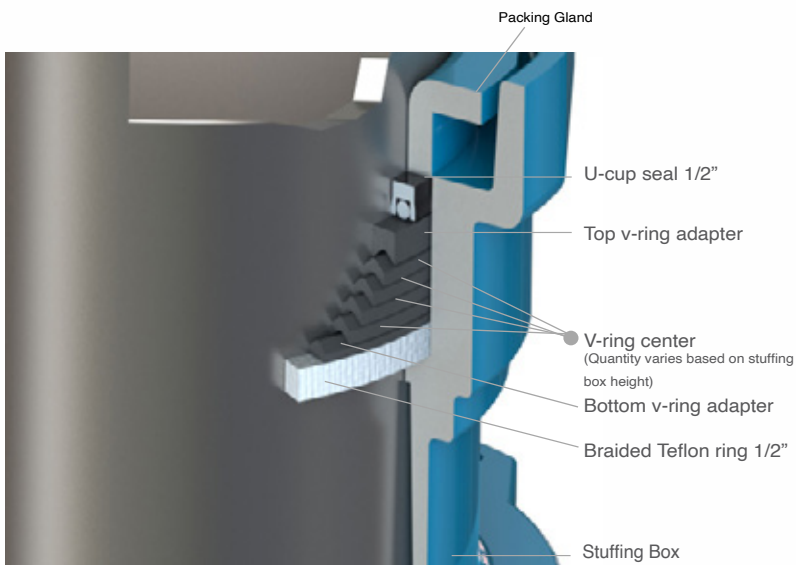

Wastecorp Plunger Pac™

Plunger Pac V-type packing is designed to reduce friction and abrasion. Reduces scoring of plungers. Includes top u-cup seal, duck rubber v-rings and bottom Teflon braided rope which responds immediately to pressure fluctuation.

Sizes*

7" (Q. 1 u-cup, 5 v-rings, 1 1/2" Teflon rope)	42686-00
9" (Q. 1 u-cup, 6 v-rings, 1 1/2" teflon rope)	42687-00
11" (Q. 1 u-cup, 7 v-rings, 1 1/2" Teflon rope)	42688-00

* Shown for genuine OEM Wastecorp Plunger Pumps. Sizes and lengths available for any brand. Contact factory for more information.

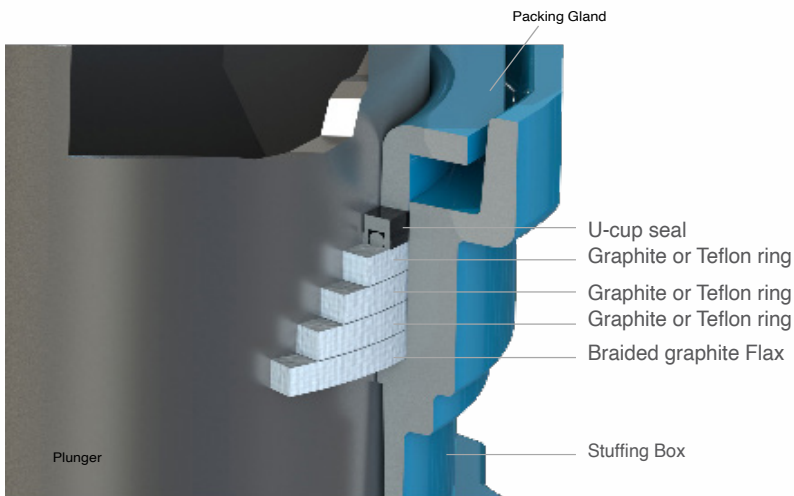
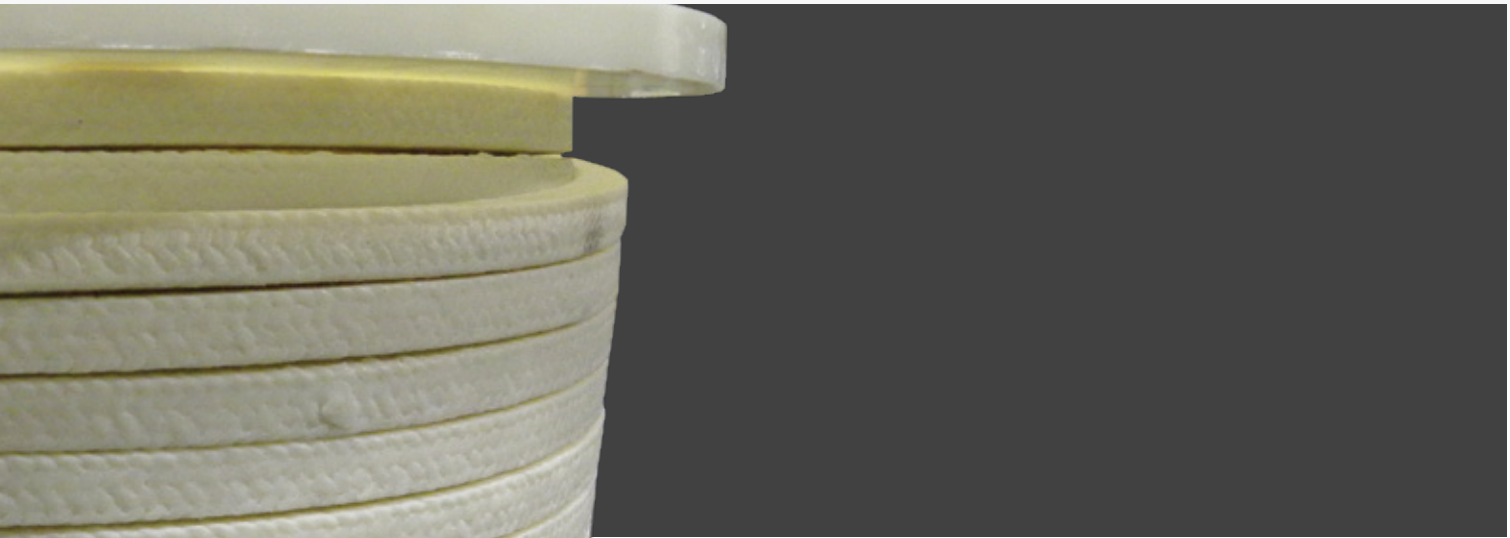

Wastecorp Graphite/Teflon® Set With U-cup Seal

Teflon PTFE compression packing, is known for its exceptionally high resistance to chemicals and low friction. Low friction finish prevents leakage through the braid. Includes top urethane bevel lip u-cup seal which responds immediately to pressure fluctuation.

Graphite with u-cup

7" (3 rings, 1 u-cup)	60655-00
9" (4 rings, 1 u-cup)	60656-00
11" (4 rings, 1 u-cup)	60657-00

Teflon® with u-cup

7" (3 rings, 1 u-cup)	60840-00
9" (4 rings, 1 u-cup)	60841-00
11" (4 rings, 1 u-cup)	60842-00

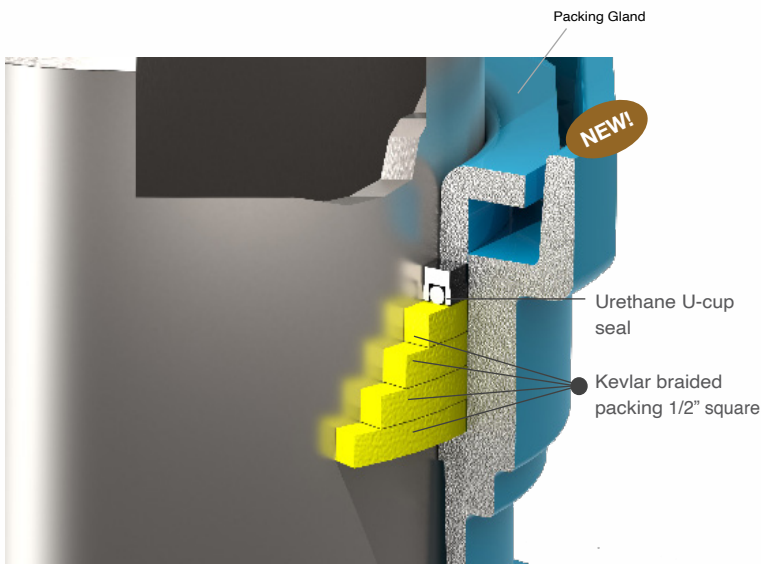

Kevlar Braided Packing

Kevlar braided fibre packing is designed with an inert lubricant. Extremely durable, highly abrasive resistant packing. Ideal for slurry and sludge pumping. Includes top urethane bevel lip u-cup seal which responds immediately to pressure fluctuation.

Sizes

7" (stack height 2")	60658-00
9" (stack height 2 1/2")	60653-00
11" (stack height 2 1/2")	60654-00

Plunger Options

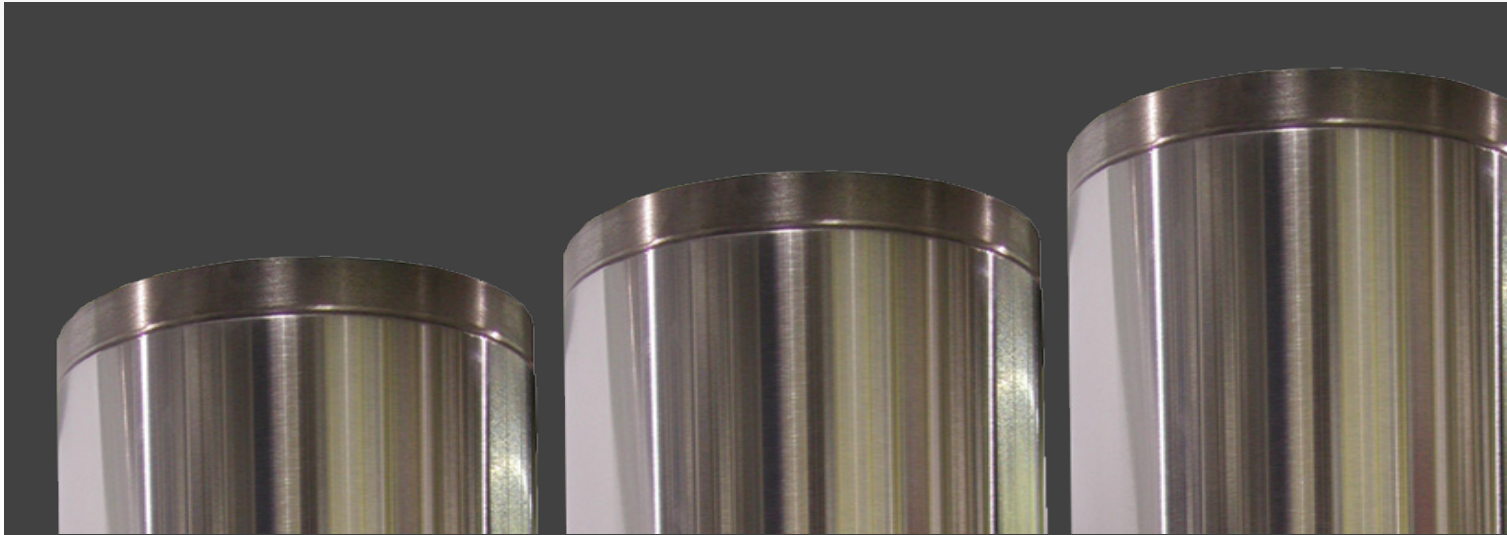

What Type of Plunger is Best for Your Facility?

Ductile Iron (Standard Base Material)

- Ductile iron is used for general municipal sewage handling applications and select industrial slurry applications

Stainless Steel

- Ideal for USDA approved food processing applications.
- Safeguards plunger from chemicals, oils, alkalis, food acids, water immersion, abrasion and more

Aluminum Oxide

- Superior hardness of plunger.
- Used for pumping abrasive materials found in municipal and industrial sludge.

Tungsten Carbide

- Offers up to three times the strength and durability of cast iron for higher volume wastewater treatment applications.
- Where fluid handling temperatures are higher.

Hard Chrome

- Reduces friction.
- Adds wear resistance.
- Extends plunger life by up to 50%.

Nickel Chromium oxide

- Harsh pumping conditions with superior abrasion resistance.
- Use for higher than normal content of sand or salt.

Sizes

7" Cast iron (ground & polished)	20937-02
7" Nickel/chrome oxide plated	20937-12
7" cast iron plunger, hard chrome	20937-08
7" stainless steel	20937-10
7" tungsten carbide	41402-10
9" cast iron plunger	15041-02
9" aluminum oxide	41272-00
9" chrome oxide	45929-00
9" hard chrome (Rc 65)	15041-08
9" nickel chrome plated plunger	15041-12
9" stainless steel	15041-10
9" tungsten carbide	41272-10
11" cast iron	15338-02
11" nickel/chrome oxide	15338-12
11" chrome oxide (3007)	45930-00
11" hard chrome	15338-08
11" tungsten carbide	41273-10
11" stainless steel	15338-10
11" aluminum oxide	41273-00



Selecting the correct plunger coating option can reduce maintenance and lower your operating costs in the long term.

Oiler Options



Premium Pump Lubricating Systems

Oiler, 12 oz. Manual adjustable flow	16169-00
Oiler, 5 oz. Manual adjustable flow	16168-00
Oiler, electric solenoid shut-off, 1 feed, 120/240 VAC, 1 pint (16 oz).	40263-00
Oiler, electric solenoid shut-off, 2 feed, 1 qt. capacity, 120/240 VAC	41003-00
Oiler, electric solenoid shut-off, 3 feed, 2 qt. capacity, 120/240 VAC	39885-00
Oiler, electric solenoid shut-off, 4 feed, 2 qt. capacity, 120/240 VAC	41009-00
Oiler, electric solenoid shut-off, 6 feed, 2 qt. capacity, 120/240 VAC	39985-00
Oiler, electric solenoid shut-off, 9 feed/120/240 VAC 1 gallon capacity	41384-00
Oiler, manual sight feed w/needle valve	60371-00
Oiler, mechanical force feed (1 fd)	46802-00
Oiler, mechanical force feed (2 fd)	39384-00
Oiler, mechanical force feed (3 fd)	37410-00
Oiler, mechanical force feed (6 fd)	46798-00
Oiler, mechanical force feed (4 fd)	46799-00
Oiler, mechanical force feed (9 fd)	46797-00

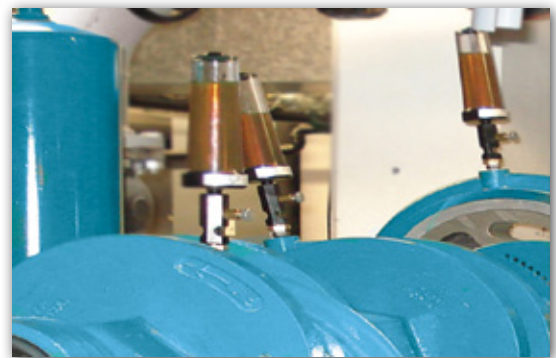

Standard oiler system

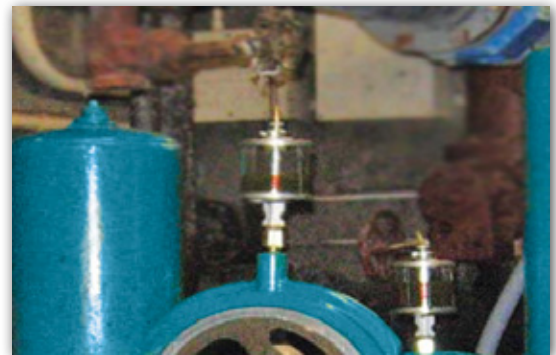

Electric oiler system

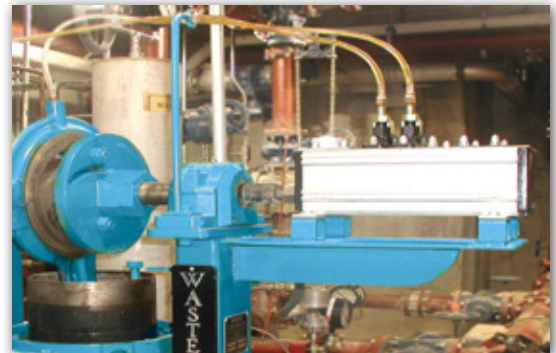

Aftermarket Plunger Pump Rebuild Options

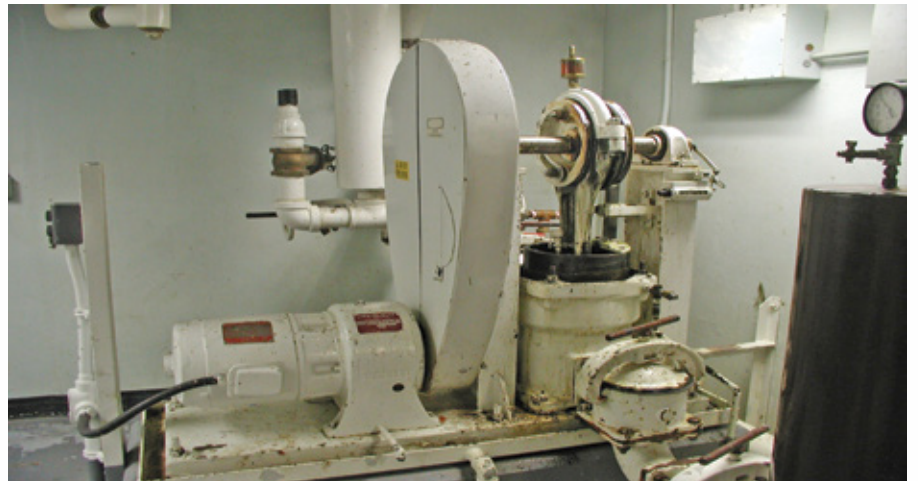

Wastecorp Plunger Pump Overhauls

Wastecorp offers complete overhaul or retrofit kit services for all makes and models of plunger pumps. Complete overhauls can be completed at your facility or sent to our factory for servicing.

Which Brands Do We Retrofit?

Wastecorp overhauls and retrofit kits are available for any brand of sewage style plunger pump including:

- All PE, HPE and EHPE Series after 1950
- Komline-Sanderson
 - KSK-7.5
 - KSK-9
 - KSK11
- Carter Pump
 - 695 Series
 - 795 Series
 - 801 Series



Complete Overhauls

For facilities that require a complete plunger pump overhaul Wastecorp can either complete the overhaul at your facility or you can send your pump to us. All service is performed by factory trained plunger pump experts and covered by our warranty program. Contact factory for details.

Retrofit Kits

A Wastecorp retrofit is a great way to save on multiple components for any plunger pump make or model. These kits are pre-assembled and sent to you ready to simply bolt in. We offer:

- Connecting rod assembly
- Shaft assembly
- Plunger assembly
- Valve chamber assembly
- Stuffing box assembly

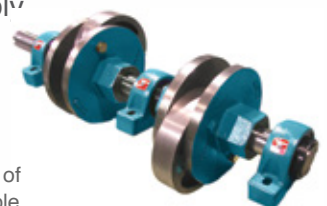

Complete shaft assembly is one of many "bolt-in" retrofit kits available.

Sample Plunger Pump Installations



HPE-1142 plunger pump at a Boston, MA water pollution control facility. Pump includes a direct drive motor with a block heater to manage seasonal changes in weather. Higher head application which included dual ball valves for thicker slurry and sludge.



HPE 81W at a New Jersey wastewater treatment plant. The belt driven model has been favored by this facility's operators for decades. When it was time to replace the existing plunger pump the operators opted for the same belt driven design for enhanced pumping productivity.



Model PE-9-SS Plunger pump in a Riverside County, California wastewater treatment plant. The facility replaced rotary lobe pumps with next generation plunger pump technology. The space saving design shown reduces the pump footprint by 35%. Application involves pumping thickened fermented sludge from a digester.



Model PE-941 dual ball valve at an upstate New York municipal sewage treatment facility. Facility upgrade involved upgrading control panels and pumping equipment. Wastecorp replaced Koline Sanderson and Carter plunger pumps. Dual ball valve configuration assists in pumping high solids above 15%.

North America: 1-888-829-2783

Fax: 1-888-883-3320

Worldwide: +1-201-445-2882

Fax: +1-201-445-3252

E-mail: info@wastecorp.com

Internet: www.wastecorp.com

THE FIRST PLUNGER PUMP. STILL THE BEST PLUNGER PUMP.

Wastecorp Pumps is the world's leading manufacturer of sewage style plunger pumps. Our Sludge Master plunger pump product line is available in three series; PE, HPE and EHPE Series. For more than 80 years and with over 18,000 pump installations, these pumps are synonymous with leadership, quality and efficient performance in the field of municipal and industrial waste fluid handling. Today, Sludge Master Plunger Pumps are accepted as the standard of performance and comparison with unprecedented innovation and design changes.



WASTECORP.
Pumps[®]

Specifications, literature and illustrative material in this plunger pump, sewage pump brochure are accurate at the time of publication but are subject to change without notice.

Illustrations may include optional equipment and accessories and may not include all standard equipment. Wastecorp and globes are trademarks of WPI/Wastecorp Pumps. Wastecorp Pumps is the exclusive manufacturer of these brands worldwide under license. Marks are protected in North America and worldwide.

© 1993-2022 WPI. All rights reserved. New York, NY 10024.

NYC/West85 DJS.

Litho in the United States of America.

For a complete engineering specification contact Wastecorp Pumps at 1.888.829.2783 or by E-mail: info@wastecorp.com.